

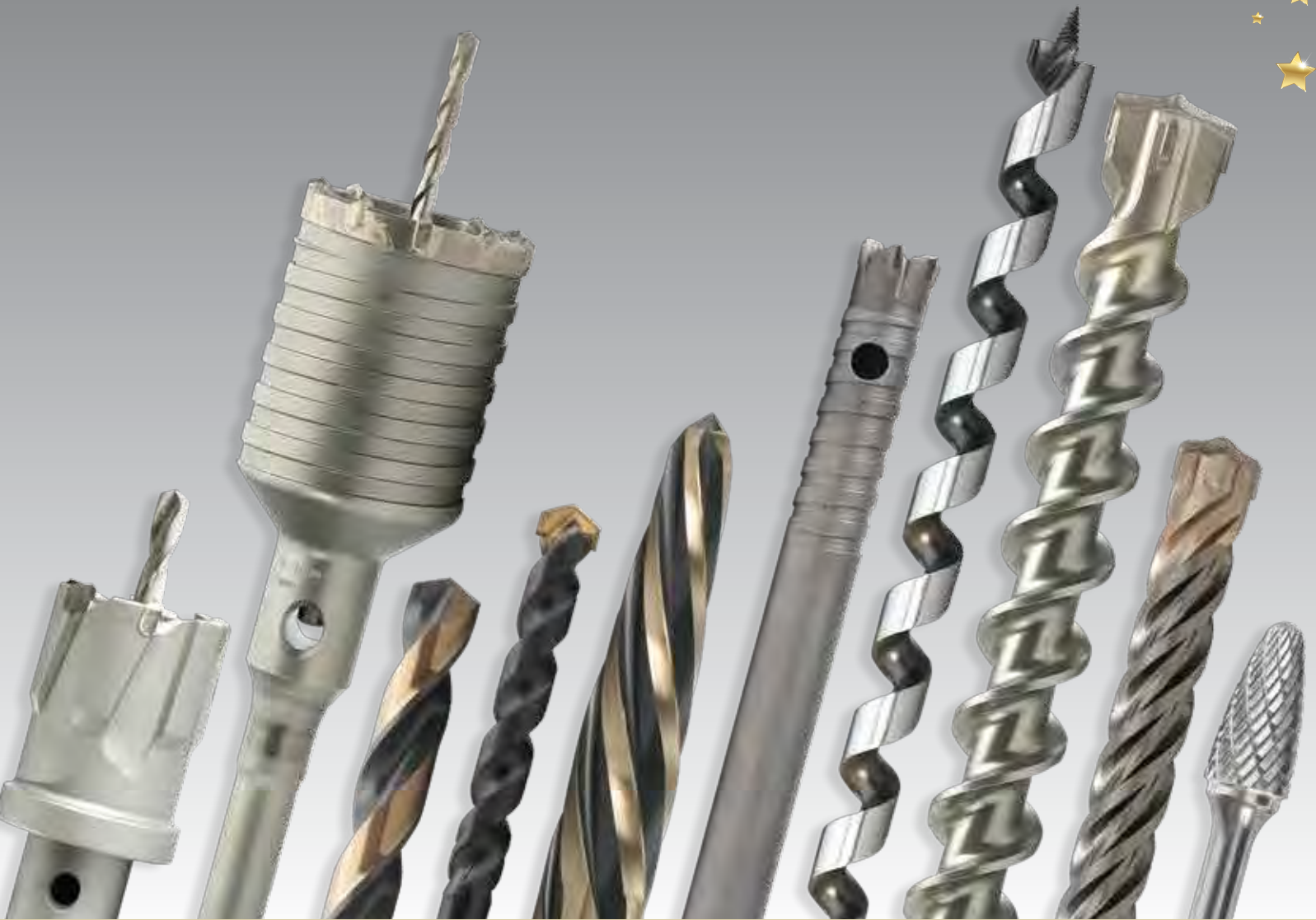

ITM



"ANYTHING THAT MAKES A HOLE"[®]



CONSTRUCTION DRILLING AND CUTTING SOLUTIONS

WWW.ITMTOOLS.COM | (800) 247-5696 | SALES@ITMTOOLS.COM



100% LAB TESTED

FAST DELIVERY

4000 items and 99% of all orders are shipped the same day if received before 3 P.M. Eastern Time.

EASY ORDERING

Order toll free, by fax, or email, either by part number or description. Our staff will quickly help you decide which product best fits your application. Order what you need, there is never a minimum order.

COMPLETE SATISFACTION

Simple: all of your purchases must satisfy you completely, or we will issue you a refund, exchange, or credit.

ITM catalogs are always made with YOU in mind! We hope you find our catalog easy to use and our staff a valuable resource for your business.

Thank you for your business and patronage.

Call us. We are here to make your life a little bit easier.

Sincerely yours,

Berardo Paradiso
President - ITM Corp.

Alberic Paradiso

Bryan Markell

Gwen Rodgers

Jonathon Sessions

Desi Persaud

Annette Kempadoo

Marilyn Rodriguez

Pam Sullivan

Chun Keat



p.10 Two Tone Jobbers HSS 118° Point



p.10 Bright Finish Jobbers HSS 118° Point



p.11 Black Oxide Jobbers HSS 118° Point



p.11 Black Oxide Wire Gauge HSS 118° Point



p.12 Black Oxide Jobbers HSS 135° Split Point



p.12 Black Oxide Wire Gauge HSS 135° Split Point



p.13 Black Oxide Letter HSS 135° Split Point



p.13 Black Oxide Metric HSS 118° Point



p.14 Black Oxide Stub Length HSS 135° Split Point



p.15 Black Oxide Silver & Deming HSS 118° Point

BLACK Oxide



p.17 Black & Gold Jobbers HSS 135° Split Point



p.17 Black & Gold Wire Gauge HSS 135° Split Point



p.18 Black & Gold Mechanics Length HSS 135° Split Point



p.19 Black & Gold Letter Size HSS 135° Split Point



p.19 Black & Gold Silver & Deming HSS 118° Split Point

Black & Gold



p.20 Cobalt Jobbers 135° Split Point



p.20 Cobalt Wire Gauge 135° Split Point



p.21 Cobalt Stub Length 135° Split Point



p.21 Cobalt Silver & Deming 118° Split Point

Cobalt



p.22 Titanium (TiN) Jobbers HSS 135° Split Point



p.22 Spotweld Double End Drills



p.22 Double End Drills 135° Split Point



p.23 Aircraft HSS 135° Split Point (6", 12" & 18" Long)



p.24 MRO Black & Gold Jobbers 135° Split Point



p.25 MRO Black & Gold Wire Gauge 135° Split Point



p.26 Parabolic Jobbers 135° Split Point



p.26 Cobalt Jobbers 135° Split Point

Made In



p.27 Bullet Case Drill Bit Sets



p.28+ Metal Drill Bit Sets / Dispenser



Tap & Drill Sets

Counter Sinks

Screw Extractors

Taps, Carbon Steel

Taps, HSS

Taps, NPT

Hand Tap Wrenches

Combo Drill Taps

Spiral Point (Gun) Taps

Wire Brushes

Rednut Wire Cup Adapter

Burs - Solid Carbide

Step Drills HSS

Reamers

Annular Cutters HSS

T.C.T. Annular Cutters

T.C.T. Hole Cutters

Roto Plate Cutters

Hole Saws - Bi-Metal

Hole Saws - Carbide Tipped

Hole Saws - Carbide Grit

Pilot Drills and Accessories

Arbors

p.30

p.32

p.32

p.34

p.35

p.36

p.36

p.37

p.37

p.38

p.38

p.40

p.42

p.44+

p.48

p.49

p.50

p.52

p.53

p.54

p.55

p.56

p.57





p.59 Reciprocating Blades - Bi-Metal



p.60 Reciprocating Blades - Bi-Metal
Heavy Metal, Heavy Duty & Demolition



p.62 Reciprocating Blades - Retail Packs



p.64 Jig Saw Blades - Bi-Metal



p.65 Hack-Saw Blades - Bi-Metal



p.65 Band-Saw Blades - Bi-Metal



p.66 Metal Display Racks



p.67 Electrician's Flex Bit (Stretch Bit)



p.67 Circular Saw Blades - Wood



p.68 Bell Hanger Drills (Fish Hole Drills)
HSS & Carbide Tipped



p.69 Long Boy Drills HSS (12" & 18")



p.69 Brad Point Wood Drills



p.70 Spade Drills



p.71 Self Feed (Multispur) Wood Drills



p.71 Extensions (For Ship Augers / Multispur)



p.72 Power Pole Auger Drills



p.73 Ship Auger Wood Drills (8" & 18" Long)



p.74 Single Spur / Double Spur Wood Drills



p.75 Oscillating Blades / Drywall Cutter



p.76 V Groove Tile Bit



p.76 Diamond Tile Bit



p.76 Glass Drills



p.77 Multi Purpose Drills - Carbide



p.77 Hard Steel Drills -
Cast Iron / Safes



Masonry Drills - Black Oxide - Slow Spiral

p.78



Roto Percussion Masonry Drills

p.79



SDS-Plus Redline

p.81



SDS-Plus Bohr Hammer

p.82+



SDS-Plus X-Cutter

p.86



SDS-Plus Evolution

p.87



SDS+ Stop (For Drop In Anchors)

p.88



SDS-Plus Adapters

p.88



Tap-Con Drills

p.89



SDS-HEX Hammer Drills

p.89



Concrete Screw Sleeve

p.89



SDS-Max Hammer Drills

p.91



Extension Systems / Adapters

p.92



Core Bits - SDS-Plus Exacto

p.93



Core Bits - SDS-Max Taper Shanks

p.94



Core Bits - SDS-Max 1 Piece

p.95



Tunnel Bore Drills

p.96



Ratio Drilling System

p.97



Spline Hammer Drills

p.98



Duster Hammer Bits (HEPA Vacuums)

p.100



Dust Pro Cups (HEPA Vacuums)

p.101

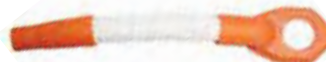



p.102 Rebar Cutters



p.104 Chisels



p.106 Composite Cutters



p.107 Diamond Core Bits - SDS-Plus Superdry



p.108 Diamond Core Bits (Wet Drilling)



p.110 Diamond Core Bits (Dry Drilling)



p.111+ Diamond Cutting Wheels



p.114+ Screwdriver Insert Bits



p.120 Bit Holders



p.122 Sockets (Magnetic Impact) & Drivers



p.123 Nut Setters - Magnetic / Impact Protection



p.124 Insert Bit Sets & MEGAPRO Screwdriver



p.126 Cable Ties



p.127 Plastic Anchor Kits



p.127 Metal Anchors



p.128 Utility Knives and Accessories

Terms Of Sale

Terms: 2% 10 Days, Net 30 Days. All credit cards welcome.

Credit: Open account privileges are extended to any firm that is satisfactorily rated. New accounts should submit at least 3 commercial references including all contact information and their tax resale number.

Quantities: Although there is no minimum purchase order, we reserve the right to adjust any order to the minimum packaged quantities indicated in catalog.

Freight: Prepaid for NET invoices equaling \$600 or more.

EFFECTIVE August, 2018.



expertise

because drilling solutions



can be out of the ordinary





HSS TOOL DATA

Suggested Drill Bits To Be Used For Various Types Of Materials:

| MATERIAL | DRILL STYLE | ANGLE POINT | PRESSURE TO APPLY | COOLANT OR LUBRICANT |
|---|-------------------------------------|-------------------------|-------------------|---------------------------|
| CARBON STEEL DUCTILE STEEL BRASS BRONZE | GENERAL PURPOSE DRILLS | 118° POINT | MEDIUM TO HEAVY | OIL or WATER SOLUTION |
| CARBON STEEL ALUMINUM AUSTENITIC STAINLESS STEEL | HEAVY DUTY AND TITANIUM | 135° SPLIT POINT | MEDIUM TO HEAVY | OIL or ACTIVATED SOLUTION |
| STAINLESS STEEL SERIES C CAST IRON | COBALT DRILLS | 135° SPLIT POINT | MEDIUM TO HEAVY | OIL or ACTIVATED SOLUTION |
| HARD STEEL HEAT TREATED ALLOYS | HARD BODY CARBIDE TIPPED AND COBALT | 130° & 135° SPLIT POINT | HEAVY | OIL or ACTIVATED SOLUTION |

Chemical Analysis Of The Three Primary High Speed Steels Used To Manufacture HSS Drill Bits:

| TYPE | CHEMICAL COMPOSITION | | | | | | ROCKWELL C HARDNESS | TERM |
|------|----------------------|----------|------------|----------|----------|--------|---------------------|--------------|
| | CARBON | TUNGSTEN | MOLYBDENUM | CHROMIUM | VANADIUM | COBALT | | |
| M2 | 0.85 | 6.00 | 5.00 | 4.00 | 1.90 | - | 63-65 | HSS |
| M35 | 1.10 | 1.50 | 9.50 | 1.15 | 1.15 | 5.00 | 65-67 | COBALT |
| M42 | 1.10 | 1.50 | 9.50 | 1.15 | 1.15 | 8.00 | 65-67 | SUPER COBALT |

M2 "HSS" is the standard material used for all **ITM** drill bits. M2 has good red-hardness and retains its cutting edge longer than other general purpose high speed steels because of its increased quantity of tungsten (dull red heat up to 1000° F without loss of hardness or rapid dulling of cutting edge). M2 is generally favored for high production machine work.

M35 M35 is the standard cobalt material used for most **ITM** cobalt drill bits. M35 has excellent resistance to abrasion and very good red-hardness for working difficult materials.

M42 M42 "Super Cobalt" is American made premium cobalt material used for higher performance **ITM** cobalt drill bits. M42 has the best resistance to abrasion and red-hardness.

COBALT DRILLS

Made of the finest Cobalt steel obtainable and furnished with a 135° split point, these drills are designed for use in machining hard, tough materials beyond the normal cutting capabilities of regular high speed steel tools. These include work-hardening grades of stainless steels, titanium, high temperature alloys, and many other heat treated materials. In addition, due to their resistant properties, they can also be used at higher speeds to drill abrasive plastics, cast iron, and other types of difficult to machine work materials.



Always Use Protection When Drilling.

Always Use High RPM For Smaller Diameters and Lower RPM For Larger Diameters.

HSS TOOL DATA

Understanding High Speed Steel Drill Bits:

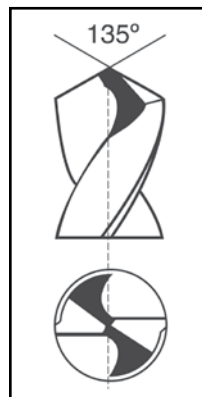
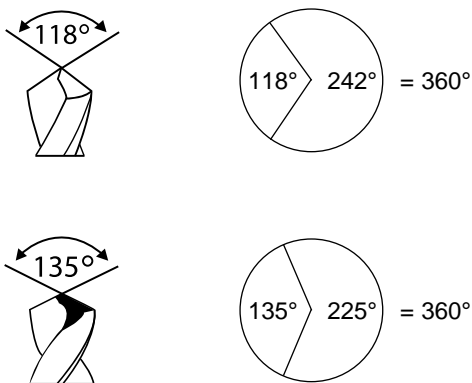

Split Point

An extra cutting angle on the 2 cutting edges of a drill bit.

Split Point is designated here in black.

Split Pointing is almost always reserved for 135° HSS drill bits.

118° drill bits have a sharp point and are common on standard / general purpose drill bits where light duty work is needed. Because of this sharp point, 118° drill bits will tend to “walk” or spin like a top on flat surfaces. This is why a centering drill or center punch is normally used to start off holes. If the operator has very steady hands, then the 118° drill bit can be used without center punching.

135° drill bits have a flatter point which gives the drill bit more cutting surface area. When more surface area cuts the steel, drilling is faster.



Understanding Nomenclature Vis-a-vis Size:

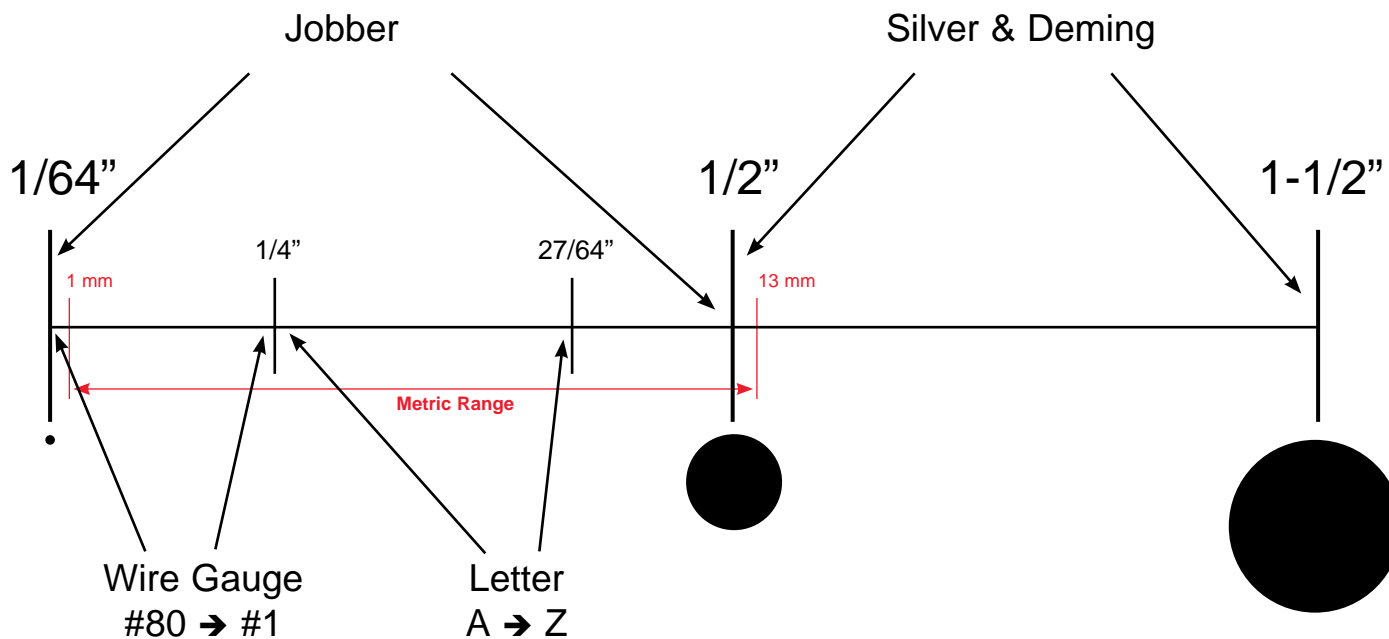

Chart Not To Scale.



Jobber Drills - General Purpose - TWO TONE FINISH M2 HSS

- ◆ Jobber Length
- ◆ 118° Point
- ◆ General Purpose
- ◆ Roll Forged
- ◆ Straight Shank
- ◆ Two Tone Finish
- ◆ M2 HSS

- ➔ Cast Iron
- ➔ Steel
- ➔ Steel Forging
- ➔ Light to Medium Materials

| Part # | Size | Dec. | OAL | Flute | Qty. | List | Part # | Size | Dec. | OAL | Flute | Qty. | List |
|-----------|--------|-------|--------|----------|------|--------|-----------|--------|-------|--------|----------|------|---------|
| 200HS0464 | 1/16" | .0625 | 1-7/8" | 7/8" | 12 | \$0.92 | 200HS1964 | 19/64" | .2969 | 4-3/8" | 3-1/16" | 12 | \$3.29 |
| 200HS0564 | 5/64" | .0781 | 2" | 1" | 12 | \$0.92 | 200HS2064 | 5/16" | .3125 | 4-1/2" | 3-3/16" | 12 | \$3.40 |
| 200HS0664 | 3/32" | .0938 | 2-1/4" | 1-1/4" | 12 | \$0.92 | 200HS2164 | 21/64" | .3281 | 4-5/8" | 3-5/16" | 6 | \$3.83 |
| 200HS0764 | 7/64" | .1094 | 2-5/8" | 1-1/2" | 12 | \$0.92 | 200HS2264 | 11/32" | .3438 | 4-3/4" | 3-7/16" | 6 | \$4.36 |
| 200HS0864 | 1/8" | .1250 | 2-3/4" | 1-5/8" | 12 | \$0.92 | 200HS2364 | 23/64" | .3594 | 4-7/8" | 3-1/2" | 6 | \$4.98 |
| 200HS0964 | 9/64" | .1406 | 2-7/8" | 1-3/4" | 12 | \$1.02 | 200HS2464 | 3/8" | .3750 | 5" | 3-5/8" | 6 | \$5.64 |
| 200HS1064 | 5/32" | .1562 | 3-1/8" | 2" | 12 | \$1.06 | 200HS2564 | 25/64" | .3906 | 5-1/8" | 3-3/4" | 6 | \$6.11 |
| 200HS1164 | 11/64" | .1719 | 3-1/4" | 2-1/8" | 12 | \$1.16 | 200HS2664 | 13/32" | .4062 | 5-1/4" | 3-1/8" | 6 | \$6.28 |
| 200HS1264 | 3/16" | .1875 | 3-1/2" | 2-5/16" | 12 | \$1.29 | 200HS2764 | 27/64" | .4219 | 5-3/8" | 3-15/16" | 6 | \$6.96 |
| 200HS1364 | 13/64" | .2031 | 3-5/8" | 2-7/16" | 12 | \$1.49 | 200HS2864 | 7/16" | .4375 | 5-1/2" | 4-1/16" | 6 | \$7.45 |
| 200HS1464 | 7/32" | .2188 | 3-3/4" | 2-1/2" | 12 | \$1.66 | 200HS2964 | 29/64" | .4531 | 5-5/8" | 4-3/16" | 6 | \$8.79 |
| 200HS1564 | 15/64" | .2344 | 3-7/8" | 2-5/8" | 12 | \$1.91 | 200HS3064 | 15/32" | .4688 | 5-3/4" | 4-5/16" | 6 | \$8.93 |
| 200HS1664 | 1/4" | .2500 | 4" | 2-3/4" | 12 | \$2.15 | 200HS3164 | 31/64" | .4844 | 5-7/8" | 4-3/8" | 6 | \$9.49 |
| 200HS1764 | 17/64" | .2656 | 4-1/8" | 2-7/8" | 12 | \$2.68 | 200HS3264 | 1/2" | .5000 | 6" | 4-1/2" | 6 | \$10.72 |
| 200HS1864 | 9/32" | .2812 | 4-1/4" | 2-15/16" | 12 | \$3.06 | | | | | | | |



Jobber Drills - General Purpose - BRIGHT FINISH M2 HSS

- ◆ Jobber Length
- ◆ 118° Point
- ◆ General Purpose
- ◆ Ground Flute
- ◆ Straight Shank
- ◆ Bright Finish
- ◆ M2 HSS

- ➔ Cast Iron
- ➔ Steel
- ➔ Steel Forging
- ➔ Light to Medium Materials

| Part # | Size | Dec. | OAL | Flute | Qty. | List | Part # | Size | Dec. | OAL | Flute | Qty. | List |
|-----------|--------|-------|--------|---------|------|--------|-----------|--------|-------|--------|----------|------|---------|
| 250US0164 | 1/64" | .0156 | 3/4" | 3/16" | 12 | \$1.45 | 250US1764 | 17/64" | .2656 | 4-1/8" | 2-7/8" | 12 | \$3.81 |
| 250US0264 | 1/32" | .0312 | 1-3/8" | 1/2" | 12 | \$1.45 | 250US1864 | 9/32" | .2812 | 4-1/4" | 2-15/16" | 12 | \$4.10 |
| 250US0364 | 3/64" | .0469 | 1-3/4" | 3/4" | 12 | \$1.45 | 250US1964 | 19/64" | .2969 | 4-3/8" | 3-1/16" | 12 | \$4.62 |
| 250US0464 | 1/16" | .0625 | 1-7/8" | 7/8" | 12 | \$0.93 | 250US2064 | 5/16" | .3125 | 4-1/2" | 3-3/16" | 12 | \$5.67 |
| 250US0564 | 5/64" | .0781 | 2" | 1" | 12 | \$0.93 | 250US2164 | 21/64" | .3281 | 4-5/8" | 3-5/16" | 6 | \$5.96 |
| 250US0664 | 3/32" | .0938 | 2-1/4" | 1-1/4" | 12 | \$0.93 | 250US2264 | 11/32" | .3438 | 4-3/4" | 3-7/16" | 6 | \$6.48 |
| 250US0764 | 7/64" | .1094 | 2-5/8" | 1-1/2" | 12 | \$0.93 | 250US2364 | 23/64" | .3594 | 4-7/8" | 3-1/2" | 6 | \$7.44 |
| 250US0864 | 1/8" | .1250 | 2-3/4" | 1-5/8" | 12 | \$1.00 | 250US2464 | 3/8" | .3750 | 5" | 3-5/8" | 6 | \$7.96 |
| 250US0964 | 9/64" | .1406 | 2-7/8" | 1-3/4" | 12 | \$1.14 | 250US2564 | 25/64" | .3906 | 5-1/8" | 3-3/4" | 6 | \$9.82 |
| 250US1064 | 5/32" | .1562 | 3-1/8" | 2" | 12 | \$1.38 | 250US2664 | 13/32" | .4062 | 5-1/4" | 3-1/8" | 6 | \$10.49 |
| 250US1164 | 11/64" | .1719 | 3-1/4" | 2-1/8" | 12 | \$1.67 | 250US2764 | 27/64" | .4219 | 5-3/8" | 3-15/16" | 6 | \$11.15 |
| 250US1264 | 3/16" | .1875 | 3-1/2" | 2-5/16" | 12 | \$1.91 | 250US2864 | 7/16" | .4375 | 5-1/2" | 4-1/16" | 6 | \$11.58 |
| 250US1364 | 13/64" | .2031 | 3-5/8" | 2-7/16" | 12 | \$2.15 | 250US2964 | 29/64" | .4531 | 5-5/8" | 4-3/16" | 6 | \$12.11 |
| 250US1464 | 7/32" | .2188 | 3-3/4" | 2-1/2" | 12 | \$2.34 | 250US3064 | 15/32" | .4688 | 5-3/4" | 4-5/16" | 6 | \$14.16 |
| 250US1564 | 15/64" | .2344 | 3-7/8" | 2-5/8" | 12 | \$2.81 | 250US3164 | 31/64" | .4844 | 5-7/8" | 4-3/8" | 6 | \$14.82 |
| 250US1664 | 1/4" | .2500 | 4" | 2-3/4" | 12 | \$3.24 | 250US3264 | 1/2" | .5000 | 6" | 4-1/2" | 6 | \$16.21 |



Jobber Drills - General Purpose - BLACK FINISH M2 HSS

| Part # | Size | Dec. | OAL | Flute | Qty. | List | Part # | Size | Dec. | OAL | Flute | Qty. | List |
|-----------|--------|-------|--------|----------|------|--------|-----------|--------|-------|--------|----------|------|--------|
| 200BF0464 | 1/16" | .0625 | 1-7/8" | 7/8" | 12 | \$0.75 | 200BF1964 | 19/64" | .2969 | 4-3/8" | 3-1/16" | 12 | \$2.36 |
| 200BF0564 | 5/64" | .0781 | 2" | 1" | 12 | \$0.75 | 200BF2064 | 5/16" | .3125 | 4-1/2" | 3-3/16" | 12 | \$2.41 |
| 200BF0664 | 3/32" | .0938 | 2-1/4" | 1-1/4" | 12 | \$0.75 | 200BF2164 | 21/64" | .3281 | 4-5/8" | 3-5/16" | 6 | \$2.73 |
| 200BF0764 | 7/64" | .1094 | 2-5/8" | 1-1/2" | 12 | \$0.75 | 200BF2264 | 11/32" | .3438 | 4-3/4" | 3-7/16" | 6 | \$3.16 |
| 200BF0864 | 1/8" | .1250 | 2-3/4" | 1-5/8" | 12 | \$0.75 | 200BF2364 | 23/64" | .3594 | 4-7/8" | 3-1/2" | 6 | \$3.56 |
| 200BF0964 | 9/64" | .1406 | 2-7/8" | 1-3/4" | 12 | \$0.75 | 200BF2464 | 3/8" | .3750 | 5" | 3-5/8" | 6 | \$3.66 |
| 200BF1064 | 5/32" | .1562 | 3-1/8" | 2" | 12 | \$0.78 | 200BF2564 | 25/64" | .3906 | 5-1/8" | 3-3/4" | 6 | \$3.96 |
| 200BF1164 | 11/64" | .1719 | 3-1/4" | 2-1/8" | 12 | \$0.83 | 200BF2664 | 13/32" | .4062 | 5-1/4" | 3-7/8" | 6 | \$4.07 |
| 200BF1264 | 3/16" | .1875 | 3-1/2" | 2-5/16" | 12 | \$0.92 | 200BF2764 | 27/64" | .4219 | 5-3/8" | 3-15/16" | 6 | \$4.51 |
| 200BF1364 | 13/64" | .2031 | 3-5/8" | 2-7/16" | 12 | \$1.06 | 200BF2864 | 7/16" | .4375 | 5-1/2" | 4-1/16" | 6 | \$4.93 |
| 200BF1464 | 7/32" | .2188 | 3-3/4" | 2-1/2" | 12 | \$1.17 | 200BF2964 | 29/64" | .4531 | 5-5/8" | 4-3/16" | 6 | \$5.87 |
| 200BF1564 | 15/64" | .2344 | 3-7/8" | 2-5/8" | 12 | \$1.40 | 200BF3064 | 15/32" | .4688 | 5-3/4" | 4-5/16" | 6 | \$6.02 |
| 200BF1664 | 1/4" | .2500 | 4" | 2-3/4" | 12 | \$1.52 | 200BF3164 | 31/64" | .4844 | 5-7/8" | 4-3/8" | 6 | \$6.43 |
| 200BF1764 | 17/64" | .2656 | 4-1/8" | 2-7/8" | 12 | \$1.91 | 200BF3264 | 1/2" | .5000 | 6" | 4-1/2" | 6 | \$6.59 |
| 200BF1864 | 9/32" | .2812 | 4-1/4" | 2-15/16" | 12 | \$2.18 | | | | | | | |

- ◆ Jobber Length
- ◆ 118° Point
- ◆ General Purpose
- ◆ Roll Forged
- ◆ Straight Shank
- ◆ Black Oxide Finish
- ◆ M2 HSS

- Cast Iron
- Steel
- Steel Forging
- Light to Medium Materials



Wire Gauge Drills - General Purpose - BLACK FINISH M2 HSS

| Part # | Size | Dec. | OAL | Flute | Qty. | List | Part # | Size | Dec. | OAL | Flute | Qty. | List |
|-----------|------|-------|--------|---------|------|--------|-----------|------|-------|--------|---------|------|--------|
| 203HS0001 | 1 | .2280 | 3-7/8" | 2-5/8" | 12 | \$1.63 | 203HS0031 | 31 | .1200 | 2-3/4" | 1-5/8" | 12 | \$0.94 |
| 203HS0002 | 2 | .2210 | 3-7/8" | 2-5/8" | 12 | \$1.63 | 203HS0032 | 32 | .1160 | 2-3/4" | 1-5/8" | 12 | \$0.94 |
| 203HS0003 | 3 | .2130 | 3-3/4" | 2-1/2" | 12 | \$1.77 | 203HS0033 | 33 | .1130 | 2-5/8" | 1-1/2" | 12 | \$0.94 |
| 203HS0004 | 4 | .2090 | 3-3/4" | 2-1/2" | 12 | \$1.77 | 203HS0034 | 34 | .1110 | 2-5/8" | 1-1/2" | 12 | \$0.94 |
| 203HS0005 | 5 | .2055 | 3-3/4" | 2-1/2" | 12 | \$1.77 | 203HS0035 | 35 | .1100 | 2-5/8" | 1-1/2" | 12 | \$0.94 |
| 203HS0006 | 6 | .2040 | 3-3/4" | 2-1/2" | 12 | \$1.77 | 203HS0036 | 36 | .1065 | 2-1/2" | 1-7/16" | 12 | \$0.94 |
| 203HS0007 | 7 | .2010 | 3-5/8" | 2-7/16" | 12 | \$1.77 | 203HS0037 | 37 | .1040 | 2-1/2" | 1-7/16" | 12 | \$0.94 |
| 203HS0008 | 8 | .1990 | 3-5/8" | 2-7/16" | 12 | \$1.77 | 203HS0038 | 38 | .1015 | 2-1/2" | 1-7/16" | 12 | \$0.94 |
| 203HS0009 | 9 | .1960 | 3-5/8" | 2-7/16" | 12 | \$1.77 | 203HS0039 | 39 | .0995 | 2-3/8" | 1-3/8" | 12 | \$0.94 |
| 203HS0010 | 10 | .1935 | 3-5/8" | 2-7/16" | 12 | \$1.77 | 203HS0040 | 40 | .0980 | 2-3/8" | 1-3/8" | 12 | \$0.94 |
| 203HS0011 | 11 | .1910 | 3-1/2" | 2-5/16" | 12 | \$1.68 | 203HS0041 | 41 | .0960 | 2-3/8" | 1-3/8" | 12 | \$0.94 |
| 203HS0012 | 12 | .1890 | 3-1/2" | 2-5/16" | 12 | \$1.68 | 203HS0042 | 42 | .0935 | 2-1/4" | 1-1/4" | 12 | \$0.94 |
| 203HS0013 | 13 | .1850 | 3-1/2" | 2-5/16" | 12 | \$1.68 | 203HS0043 | 43 | .0890 | 2-1/4" | 1-1/4" | 12 | \$0.94 |
| 203HS0014 | 14 | .1820 | 3-3/8" | 2-3/16" | 12 | \$1.68 | 203HS0044 | 44 | .0860 | 2-1/8" | 1-1/8" | 12 | \$0.94 |
| 203HS0015 | 15 | .1800 | 3-3/8" | 2-3/16" | 12 | \$1.68 | 203HS0045 | 45 | .0820 | 2-1/8" | 1-1/8" | 12 | \$0.94 |
| 203HS0016 | 16 | .1770 | 3-3/8" | 2-3/16" | 12 | \$1.68 | 203HS0046 | 46 | .0810 | 2-1/8" | 1-1/8" | 12 | \$0.94 |
| 203HS0017 | 17 | .1730 | 3-3/8" | 2-3/16" | 12 | \$1.68 | 203HS0047 | 47 | .0785 | 2" | 1" | 12 | \$0.94 |
| 203HS0018 | 18 | .1695 | 3-1/4" | 2-1/8" | 12 | \$1.68 | 203HS0048 | 48 | .0760 | 2" | 1" | 12 | \$0.94 |
| 203HS0019 | 19 | .1660 | 3-1/4" | 2-1/8" | 12 | \$1.68 | 203HS0049 | 49 | .0730 | 2" | 1" | 12 | \$0.94 |
| 203HS0020 | 20 | .1610 | 3-1/4" | 2-1/8" | 12 | \$1.50 | 203HS0050 | 50 | .0700 | 2" | 1" | 12 | \$0.94 |
| 203HS0021 | 21 | .1590 | 3-1/4" | 2-1/8" | 12 | \$1.50 | 203HS0051 | 51 | .0670 | 2" | 1" | 12 | \$0.94 |
| 203HS0022 | 22 | .1570 | 3-1/8" | 2" | 12 | \$1.57 | 203HS0052 | 52 | .0635 | 1-7/8" | 7/8" | 12 | \$0.94 |
| 203HS0023 | 23 | .1540 | 3-1/8" | 2" | 12 | \$1.57 | 203HS0053 | 53 | .0595 | 1-7/8" | 7/8" | 12 | \$0.94 |
| 203HS0024 | 24 | .1520 | 3-1/8" | 2" | 12 | \$1.12 | 203HS0054 | 54 | .0550 | 1-7/8" | 7/8" | 12 | \$0.94 |
| 203HS0025 | 25 | .1495 | 3" | 1-7/8" | 12 | \$1.12 | 203HS0055 | 55 | .0520 | 1-7/8" | 7/8" | 12 | \$0.94 |
| 203HS0026 | 26 | .1470 | 3" | 1-7/8" | 12 | \$1.12 | 203HS0056 | 56 | .0465 | 1-3/4" | 3/4" | 12 | \$0.94 |
| 203HS0027 | 27 | .1440 | 3" | 1-7/8" | 12 | \$1.12 | 203HS0057 | 57 | .0430 | 1-3/4" | 3/4" | 12 | \$0.94 |
| 203HS0028 | 28 | .1405 | 2-7/8" | 1-3/4" | 12 | \$1.12 | 203HS0058 | 58 | .0420 | 1-5/8" | 11/16" | 12 | \$0.94 |
| 203HS0029 | 29 | .1360 | 2-7/8" | 1-3/4" | 12 | \$0.94 | 203HS0059 | 59 | .0410 | 1-5/8" | 11/16" | 12 | \$0.94 |
| 203HS0030 | 30 | .1285 | 2-3/4" | 1-5/8" | 12 | \$0.94 | 203HS0060 | 60 | .0400 | 1-5/8" | 11/16" | 12 | \$0.94 |

- ◆ Wire Gauge
- ◆ 118° Point
- ◆ General Purpose
- ◆ Roll Forged
- ◆ Straight Shank
- ◆ Black Oxide Finish
- ◆ M2 HSS

- Cast Iron
- Steel
- Steel Forging
- Light to Medium Materials



AVAILABLE:
SIZES 61 → 80
List \$1.80



Jobber Drills - HEAVY DUTY - BLACK OXIDE FINISH M2 HSS

- ◆ Jobber Length
- ◆ 135° Split Point
- ◆ Ground Flute
- ◆ Straight Shank
- ◆ Heavy Duty Web
- ◆ Black Oxide Finish
- ◆ M2 HSS

- ➔ Cast Iron
- ➔ Steel
- ➔ Steel Forging
- ➔ Light Gauge Stainless Steel



| Part # | Size | Dec. | OAL | Flute | Qty. | List | Part # | Size | Dec. | OAL | Flute | Qty. | List |
|-----------|--------|-------|--------|----------|------|--------|-----------|--------|-------|--------|----------|------|---------|
| 206SP0464 | 1/16" | .0625 | 1-7/8" | 7/8" | 12 | \$1.06 | 206SP1964 | 19/64" | .2969 | 4-3/8" | 3-1/16" | 12 | \$3.96 |
| 206SP0564 | 5/64" | .0781 | 2" | 1" | 12 | \$1.06 | 206SP2064 | 5/16" | .3125 | 4-1/2" | 3-3/16" | 12 | \$4.62 |
| 206SP0664 | 3/32" | .0938 | 2-1/4" | 1-1/4" | 12 | \$1.06 | 206SP2164 | 21/64" | .3281 | 4-5/8" | 3-5/16" | 6 | \$5.25 |
| 206SP0764 | 7/64" | .1094 | 2-5/8" | 1-1/2" | 12 | \$1.06 | 206SP2264 | 11/32" | .3438 | 4-3/4" | 3-7/16" | 6 | \$6.38 |
| 206SP0864 | 1/8" | .1250 | 2-3/4" | 1-5/8" | 12 | \$1.18 | 206SP2364 | 23/64" | .3594 | 4-7/8" | 3-1/2" | 6 | \$6.57 |
| 206SP0964 | 9/64" | .1406 | 2-7/8" | 1-3/4" | 12 | \$1.26 | 206SP2464 | 3/8" | .3750 | 5" | 3-5/8" | 6 | \$7.18 |
| 206SP1064 | 5/32" | .1562 | 3-1/8" | 2" | 12 | \$1.32 | 206SP2564 | 25/64" | .3906 | 5-1/8" | 3-3/4" | 6 | \$8.31 |
| 206SP1164 | 11/64" | .1719 | 3-1/4" | 2-1/8" | 12 | \$1.49 | 206SP2664 | 13/32" | .4062 | 5-1/4" | 3-7/8" | 6 | \$8.79 |
| 206SP1264 | 3/16" | .1875 | 3-1/2" | 2-5/16" | 12 | \$1.61 | 206SP2764 | 27/64" | .4219 | 5-3/8" | 3-15/16" | 6 | \$9.84 |
| 206SP1364 | 13/64" | .2031 | 3-5/8" | 2-7/16" | 12 | \$1.92 | 206SP2864 | 7/16" | .4375 | 5-1/2" | 4-1/16" | 6 | \$11.16 |
| 206SP1464 | 7/32" | .2188 | 3-3/4" | 2-1/2" | 12 | \$1.95 | 206SP2964 | 29/64" | .4531 | 5-5/8" | 4-3/16" | 6 | \$11.51 |
| 206SP1564 | 15/64" | .2344 | 3-7/8" | 2-5/8" | 12 | \$2.24 | 206SP3064 | 15/32" | .4688 | 5-3/4" | 4-5/16" | 6 | \$12.69 |
| 206SP1664 | 1/4" | .2500 | 4" | 2-3/4" | 12 | \$2.55 | 206SP3164 | 31/64" | .4844 | 5-7/8" | 4-3/8" | 6 | \$13.64 |
| 206SP1764 | 17/64" | .2656 | 4-1/8" | 2-7/8" | 12 | \$3.21 | 206SP3264 | 1/2" | .5000 | 6" | 4-1/2" | 6 | \$15.19 |
| 206SP1864 | 9/32" | .2812 | 4-1/4" | 2-15/16" | 12 | \$3.49 | | | | | | | |

Wire Gauge Drills - HEAVY DUTY - BLACK OXIDE FINISH M2 HSS

- ◆ Wire Gauge
- ◆ 135° Split Point
- ◆ Ground Flute
- ◆ Straight Shank
- ◆ Heavy Duty Web
- ◆ Black Oxide Finish
- ◆ M2 HSS

- ➔ Cast Iron
- ➔ Steel
- ➔ Steel Forging
- ➔ Light Gauge Stainless Steel



NOTE: SIZES 40 → 60 HAVE NO SPLIT POINT.

| Part # | Size | Dec. | OAL | Flute | Qty. | List | Part # | Size | Dec. | OAL | Flute | Qty. | List |
|-----------|------|-------|--------|---------|------|--------|-----------|------|-------|--------|---------|------|--------|
| 207SP0001 | 1 | .2280 | 3-7/8" | 2-5/8" | 12 | \$2.25 | 207SP0031 | 31 | .1200 | 2-3/4" | 1-5/8" | 12 | \$1.43 |
| 207SP0002 | 2 | .2210 | 3-7/8" | 2-5/8" | 12 | \$2.25 | 207SP0032 | 32 | .1160 | 2-3/4" | 1-5/8" | 12 | \$1.33 |
| 207SP0003 | 3 | .2130 | 3-3/4" | 2-1/2" | 12 | \$2.25 | 207SP0033 | 33 | .1130 | 2-5/8" | 1-1/2" | 12 | \$1.33 |
| 207SP0004 | 4 | .2090 | 3-3/4" | 2-1/2" | 12 | \$2.25 | 207SP0034 | 34 | .1110 | 2-5/8" | 1-1/2" | 12 | \$1.33 |
| 207SP0005 | 5 | .2055 | 3-3/4" | 2-1/2" | 12 | \$2.25 | 207SP0035 | 35 | .1100 | 2-5/8" | 1-1/2" | 12 | \$1.33 |
| 207SP0006 | 6 | .2040 | 3-3/4" | 2-1/2" | 12 | \$2.25 | 207SP0036 | 36 | .1065 | 2-1/2" | 1-7/16" | 12 | \$1.33 |
| 207SP0007 | 7 | .2010 | 3-5/8" | 2-7/16" | 12 | \$2.09 | 207SP0037 | 37 | .1040 | 2-1/2" | 1-7/16" | 12 | \$1.33 |
| 207SP0008 | 8 | .1990 | 3-5/8" | 2-7/16" | 12 | \$2.09 | 207SP0038 | 38 | .1015 | 2-1/2" | 1-7/16" | 12 | \$1.33 |
| 207SP0009 | 9 | .1960 | 3-5/8" | 2-7/16" | 12 | \$2.09 | 207SP0039 | 39 | .0995 | 2-3/8" | 1-3/8" | 12 | \$1.33 |
| 207SP0010 | 10 | .1935 | 3-5/8" | 2-7/16" | 12 | \$2.09 | 207SP0040 | 40 | .0980 | 2-3/8" | 1-3/8" | 12 | \$1.33 |
| 207SP0011 | 11 | .1910 | 3-1/2" | 2-5/16" | 12 | \$2.09 | 207SP0041 | 41 | .0960 | 2-3/8" | 1-3/8" | 12 | \$1.28 |
| 207SP0012 | 12 | .1890 | 3-1/2" | 2-5/16" | 12 | \$2.09 | 207SP0042 | 42 | .0935 | 2-1/4" | 1-1/4" | 12 | \$1.28 |
| 207SP0013 | 13 | .1850 | 3-1/2" | 2-5/16" | 12 | \$1.79 | 207SP0043 | 43 | .0890 | 2-1/4" | 1-1/4" | 12 | \$1.28 |
| 207SP0014 | 14 | .1820 | 3-3/8" | 2-3/16" | 12 | \$1.79 | 207SP0044 | 44 | .0860 | 2-1/8" | 1-1/8" | 12 | \$1.28 |
| 207SP0015 | 15 | .1800 | 3-3/8" | 2-3/16" | 12 | \$1.79 | 207SP0045 | 45 | .0820 | 2-1/8" | 1-1/8" | 12 | \$1.28 |
| 207SP0016 | 16 | .1770 | 3-3/8" | 2-3/16" | 12 | \$1.79 | 207SP0046 | 46 | .0810 | 2-1/8" | 1-1/8" | 12 | \$1.28 |
| 207SP0017 | 17 | .1730 | 3-3/8" | 2-3/16" | 12 | \$1.79 | 207SP0047 | 47 | .0785 | 2" | 1" | 12 | \$1.28 |
| 207SP0018 | 18 | .1695 | 3-1/4" | 2-1/8" | 12 | \$1.79 | 207SP0048 | 48 | .0760 | 2" | 1" | 12 | \$1.28 |
| 207SP0019 | 19 | .1660 | 3-1/4" | 2-1/8" | 12 | \$1.79 | 207SP0049 | 49 | .0730 | 2" | 1" | 12 | \$1.28 |
| 207SP0020 | 20 | .1610 | 3-1/4" | 2-1/8" | 12 | \$1.79 | 207SP0050 | 50 | .0700 | 2" | 1" | 12 | \$1.28 |
| 207SP0021 | 21 | .1590 | 3-1/4" | 2-1/8" | 12 | \$1.79 | 207SP0051 | 51 | .0670 | 2" | 1" | 12 | \$1.28 |
| 207SP0022 | 22 | .1570 | 3-1/8" | 2" | 12 | \$1.79 | 207SP0052 | 52 | .0635 | 1-7/8" | 7/8" | 12 | \$1.28 |
| 207SP0023 | 23 | .1540 | 3-1/8" | 2" | 12 | \$1.43 | 207SP0053 | 53 | .0595 | 1-7/8" | 7/8" | 12 | \$1.28 |
| 207SP0024 | 24 | .1520 | 3-1/8" | 2" | 12 | \$1.43 | 207SP0054 | 54 | .0550 | 1-7/8" | 7/8" | 12 | \$1.28 |
| 207SP0025 | 25 | .1495 | 3" | 1-7/8" | 12 | \$1.43 | 207SP0055 | 55 | .0520 | 1-7/8" | 7/8" | 12 | \$1.28 |
| 207SP0026 | 26 | .1470 | 3" | 1-7/8" | 12 | \$1.43 | 207SP0056 | 56 | .0465 | 1-3/4" | 3/4" | 12 | \$1.28 |
| 207SP0027 | 27 | .1440 | 3" | 1-7/8" | 12 | \$1.43 | 207SP0057 | 57 | .0430 | 1-3/4" | 3/4" | 12 | \$1.28 |
| 207SP0028 | 28 | .1405 | 2-7/8" | 1-3/4" | 12 | \$1.43 | 207SP0058 | 58 | .0420 | 1-5/8" | 11/16" | 12 | \$1.28 |
| 207SP0029 | 29 | .1360 | 2-7/8" | 1-3/4" | 12 | \$1.43 | 207SP0059 | 59 | .0410 | 1-5/8" | 11/16" | 12 | \$1.28 |
| 207SP0030 | 30 | .1285 | 2-3/4" | 1-5/8" | 12 | \$1.43 | 207SP0060 | 60 | .0400 | 1-5/8" | 11/16" | 12 | \$1.28 |



Jobber Drills - HEAVY DUTY 3/8" Shank - BLACK OXIDE FINISH M2 HSS

| Part # | Size | Dec. | OAL | Flute | Qty. | List | Part # | Size | Dec. | OAL | Flute | Qty. | List |
|-----------|--------|-------|---------|----------|------|---------|-----------|--------|-------|--------|---------|------|---------|
| 206R82564 | 25/64" | .3906 | 5-1/8" | 3-3/4" | 6 | \$14.41 | 206R82964 | 29/64" | .4531 | 5-5/8" | 4-3/16" | 6 | \$18.68 |
| 206R82664 | 13/32" | .4062 | 5-1/4" | 3-1/8" | 6 | \$14.63 | 206R83064 | 15/32" | .4688 | 5-3/4" | 4-5/16" | 6 | \$19.06 |
| 206R82764 | 27/64" | .4219 | 5 -3/8" | 3-15/16" | 6 | \$15.79 | 206R83164 | 31/64" | .4844 | 5-7/8" | 4-3/8" | 6 | \$19.67 |
| 206R82864 | 7/16" | .4375 | 5-1/2" | 4-1/16" | 6 | \$16.74 | 206R83264 | 1/2" | .5000 | 6" | 4-1/2" | 6 | \$20.23 |

◆ Same as 206SP with 3/8" Shank.



Letter Drills - HEAVY DUTY - BLACK OXIDE FINISH M2 HSS

| Part # | Size | Dec. | OAL | Flute | Qty. | List | Part # | Size | Dec. | OAL | Flute | Qty. | List |
|-----------|------|-------|--------|----------|------|--------|-----------|------|-------|--------|---------|------|---------|
| 208SP000A | A | .2340 | 3-7/8" | 2-5/8" | 12 | \$3.03 | 208SP000N | N | .3020 | 4-3/8" | 3-1/16" | 6 | \$5.21 |
| 208SP000B | B | .2380 | 4" | 2-3/4" | 12 | \$3.17 | 208SP000O | O | .3160 | 4-1/2" | 3-3/16" | 6 | \$5.34 |
| 208SP000C | C | .2420 | 4" | 2-3/4" | 12 | \$3.17 | 208SP000P | P | .3230 | 4-5/8" | 3-5/16" | 6 | \$5.77 |
| 208SP000D | D | .2460 | 4" | 2-3/4" | 12 | \$3.17 | 208SP000Q | Q | .3320 | 4-3/4" | 3-7/16" | 6 | \$5.86 |
| 208SP000E | E | .2500 | 4" | 2-3/4" | 12 | \$3.17 | 208SP000R | R | .3390 | 4-3/4" | 3-7/16" | 6 | \$5.86 |
| 208SP000F | F | .2570 | 4-1/8" | 2-7/8" | 12 | \$3.89 | 208SP000S | S | .3480 | 4-7/8" | 3-1/2" | 6 | \$7.18 |
| 208SP000G | G | .2610 | 4-1/8" | 2-7/8" | 12 | \$3.89 | 208SP000T | T | .3580 | 4-7/8" | 3-1/2" | 6 | \$7.18 |
| 208SP000H | H | .2660 | 4-1/8" | 2-7/8" | 12 | \$3.97 | 208SP000U | U | .3680 | 5" | 3-5/8" | 6 | \$7.37 |
| 208SP000I | I | .2720 | 4-1/8" | 2-7/8" | 12 | \$3.97 | 208SP000V | V | .3770 | 5" | 3-5/8" | 6 | \$7.37 |
| 208SP000J | J | .2770 | 4-1/8" | 2-7/8" | 12 | \$4.42 | 208SP000W | W | .3860 | 5-1/8" | 3-3/4" | 6 | \$8.37 |
| 208SP000K | K | .2810 | 4-1/4" | 2-15/16" | 12 | \$4.42 | 208SP000X | X | .3970 | 5-1/8" | 3-3/4" | 6 | \$9.56 |
| 208SP000L | L | .2900 | 4-1/4" | 2-15/16" | 6 | \$5.09 | 208SP000Y | Y | .4040 | 5-1/4" | 3-7/8" | 6 | \$9.86 |
| 208SP000M | M | .2950 | 4-3/8" | 3-1/16" | 6 | \$5.21 | 208SP000Z | Z | .4130 | 5-1/4" | 3-7/8" | 6 | \$11.08 |

- ◆ Jobber Length
- ◆ 135° Split Point
- ◆ Ground Flute
- ◆ Straight Shank
- ◆ Heavy Duty Web
- ◆ Black Oxide Finish
- ◆ M2 HSS
- Cast Iron
- Steel
- Steel Forging
- Light Gauge Stainless Steel



Metric Drills - General Purpose - BLACK OXIDE FINISH M2 HSS

| Part # | Size | Dec. | OAL | Flute | Qty. | List | Part # | Size | Dec. | OAL | Flute | Qty. | List |
|-----------|------|-------|-----|-------|------|--------|-----------|------|-------|-----|-------|------|---------|
| 205HS0010 | 1 | .0393 | 41 | 18 | 12 | \$1.91 | 205HS0075 | 7.5 | .2953 | 111 | 78 | 12 | \$6.08 |
| 205HS0015 | 1.5 | .0591 | 48 | 22 | 12 | \$1.91 | 205HS0080 | 8 | .3150 | 114 | 81 | 12 | \$7.02 |
| 205HS0020 | 2 | .0787 | 54 | 29 | 12 | \$1.91 | 205HS0085 | 8.5 | .3346 | 121 | 87 | 6 | \$8.37 |
| 205HS0025 | 2.5 | .0984 | 60 | 35 | 12 | \$1.91 | 205HS0090 | 9 | .3543 | 124 | 89 | 6 | \$9.37 |
| 205HS0030 | 3 | .1181 | 70 | 41 | 12 | \$1.91 | 205HS0095 | 9.5 | .3740 | 127 | 92 | 6 | \$9.70 |
| 205HS0035 | 3.5 | .1378 | 73 | 45 | 12 | \$2.06 | 205HS0100 | 10 | .3937 | 130 | 95 | 6 | \$11.42 |
| 205HS0040 | 4 | .1575 | 83 | 54 | 12 | \$2.48 | 205HS0105 | 10.5 | .4134 | 137 | 100 | 6 | \$12.49 |
| 205HS0045 | 4.5 | .1772 | 86 | 56 | 12 | \$2.88 | 205HS0110 | 11 | .4331 | 140 | 103 | 6 | \$12.66 |
| 205HS0050 | 5 | .1969 | 92 | 62 | 12 | \$3.14 | 205HS0115 | 11.5 | .4528 | 143 | 106 | 6 | \$14.73 |
| 205HS0055 | 5.5 | .2165 | 95 | 64 | 12 | \$3.62 | 205HS0120 | 12 | .4724 | 150 | 111 | 6 | \$16.42 |
| 205HS0060 | 6 | .2362 | 102 | 70 | 12 | \$4.30 | 205HS0125 | 12.5 | .4921 | 152 | 114 | 6 | \$16.42 |
| 205HS0065 | 6.5 | .2559 | 105 | 73 | 12 | \$4.63 | 205HS0130 | 13 | .5118 | 168 | 122 | 6 | \$19.46 |
| 205HS0070 | 7 | .2756 | 105 | 73 | 12 | \$5.15 | | | | | | | |

- ◆ Metric Size
- ◆ 118° Point
- ◆ General Purpose
- ◆ Roll Forged
- ◆ Straight Shank
- ◆ Black Oxide Finish
- ◆ M2 HSS
- Cast Iron
- Steel
- Steel Forging
- Light to Medium Materials



- ◆ Stub Length
- ◆ 135° Split Point
- ◆ Ground Flute
- ◆ Straight Shank
- ◆ Heavy Duty Web
- ◆ Black Oxide Finish
- ◆ M2 HSS
- Cast Iron
- Steel
- Steel Forging
- Stainless Steel
- Sheet Metal
- Automotive



STUB Fractional - HEAVY DUTY

| Part # | Size | Dec. | OAL | Flute | Qty. | List |
|-----------|--------|-------|----------|----------|------|---------|
| 209SM0464 | 1/16" | .0625 | 1-5/8" | 5/8" | 12 | \$1.10 |
| 209SM0564 | 5/64" | .0781 | 1-11/16" | 11/16" | 12 | \$1.10 |
| 209SM0664 | 3/32" | .0938 | 1-3/4" | 3/4" | 12 | \$1.10 |
| 209SM0764 | 7/64" | .1094 | 1-13/16" | 13/16" | 12 | \$1.10 |
| 209SM0864 | 1/8" | .1250 | 1-7/8" | 7/8" | 12 | \$1.10 |
| 209SM0964 | 9/64" | .1406 | 1-15/16" | 15/16" | 12 | \$1.25 |
| 209SM1064 | 5/32" | .1562 | 2-1/16" | 1" | 12 | \$1.43 |
| 209SM1164 | 11/64" | .1719 | 2-1/8" | 1-1/16" | 12 | \$1.74 |
| 209SM1264 | 3/16" | .1875 | 2-3/16" | 1-1/8" | 12 | \$2.01 |
| 209SM1364 | 13/64" | .2031 | 2-1/4" | 1-3/16" | 12 | \$2.27 |
| 209SM1464 | 7/32" | .2188 | 2-3/8" | 1-1/4" | 12 | \$2.48 |
| 209SM1564 | 15/64" | .2344 | 2-7/16" | 1-5/16" | 12 | \$2.90 |
| 209SM1664 | 1/4" | .2500 | 2-1/2" | 1-3/8" | 12 | \$3.43 |
| 209SM1764 | 17/64" | .2656 | 2-5/8" | 1-7/16" | 12 | \$3.96 |
| 209SM1864 | 9/32" | .2812 | 2-11/16" | 1-1/2" | 12 | \$4.22 |
| 209SM1964 | 19/64" | .2969 | 2-3/4" | 1-9/16" | 12 | \$4.80 |
| 209SM2064 | 5/16" | .3125 | 2-13/16" | 1-5/8" | 12 | \$5.38 |
| 209SM2164 | 21/64" | .3281 | 2-15/16" | 1-11/16" | 6 | \$6.28 |
| 209SM2264 | 11/32" | .3438 | 3" | 1-11/16" | 6 | \$6.76 |
| 209SM2364 | 23/64" | .3594 | 3-1/16" | 1-3/4" | 6 | \$7.23 |
| 209SM2464 | 3/8" | .3750 | 3-1/8" | 1-13/16" | 6 | \$8.13 |
| 209SM2564 | 25/64" | .3906 | 3-1/4" | 1-7/8" | 6 | \$9.61 |
| 209SM2664 | 13/32" | .4062 | 3-5/16" | 1-15/16" | 6 | \$10.29 |
| 209SM2764 | 27/64" | .4219 | 3-3/8" | 2" | 6 | \$10.93 |
| 209SM2864 | 7/16" | .4375 | 3-7/16" | 2-1/16" | 6 | \$11.45 |
| 209SM2964 | 29/64" | .4531 | 3-9/16" | 2-1/8" | 6 | \$12.72 |
| 209SM3064 | 15/32" | .4688 | 3-5/8" | 2-1/8" | 6 | \$13.93 |
| 209SM3164 | 31/64" | .4844 | 3-11/16" | 2-3/16" | 6 | \$15.31 |
| 209SM3264 | 1/2" | .5000 | 3-3/4" | 2-1/4" | 6 | \$16.04 |



STUB Wire Gauge - HEAVY DUTY

| Part # | Size | Dec. | OAL | Flute | Qty. | List |
|-----------|------|-------|----------|----------|------|--------|
| 210SM0001 | 1 | .2280 | 2-7/16" | 1-15/16" | 12 | \$2.85 |
| 210SM0002 | 2 | .2210 | 2-7/16" | 1-15/16" | 12 | \$2.85 |
| 210SM0003 | 3 | .2130 | 2-3/8" | 1-1/4" | 12 | \$2.42 |
| 210SM0004 | 4 | .2090 | 2-3/8" | 1-1/4" | 12 | \$2.42 |
| 210SM0005 | 5 | .2055 | 2-3/8" | 1-1/4" | 12 | \$2.42 |
| 210SM0006 | 6 | .2040 | 2-3/8" | 1-1/4" | 12 | \$2.42 |
| 210SM0007 | 7 | .2010 | 2-1/4" | 1-3/16" | 12 | \$2.15 |
| 210SM0008 | 8 | .1990 | 2-1/4" | 1-3/16" | 12 | \$2.15 |
| 210SM0009 | 9 | .1960 | 2-1/4" | 1-3/16" | 12 | \$2.15 |
| 210SM0010 | 10 | .1935 | 2-1/4" | 1-3/16" | 12 | \$2.15 |
| 210SM0011 | 11 | .1910 | 2-1/4" | 1-3/16" | 12 | \$2.15 |
| 210SM0012 | 12 | .1890 | 2-1/4" | 1-3/16" | 12 | \$2.15 |
| 210SM0013 | 13 | .1850 | 2-3/16" | 1-1/8" | 12 | \$1.83 |
| 210SM0014 | 14 | .1820 | 2-3/16" | 1-1/8" | 12 | \$1.83 |
| 210SM0015 | 15 | .1800 | 2-3/16" | 1-1/8" | 12 | \$1.83 |
| 210SM0016 | 16 | .1770 | 2-3/16" | 1-1/8" | 12 | \$1.83 |
| 210SM0017 | 17 | .1730 | 2-3/16" | 1-1/8" | 12 | \$1.83 |
| 210SM0018 | 18 | .1695 | 2-1/8" | 1-1/16" | 12 | \$1.62 |
| 210SM0019 | 19 | .1660 | 2-1/8" | 1-1/16" | 12 | \$1.62 |
| 210SM0020 | 20 | .1610 | 2-1/8" | 1-1/16" | 12 | \$1.62 |
| 210SM0021 | 21 | .1590 | 2-1/8" | 1-1/16" | 12 | \$1.62 |
| 210SM0022 | 22 | .1570 | 2-1/8" | 1-1/16" | 12 | \$1.62 |
| 210SM0023 | 23 | .1540 | 2-1/16" | 1" | 12 | \$1.35 |
| 210SM0024 | 24 | .1520 | 2-1/16" | 1" | 12 | \$1.35 |
| 210SM0025 | 25 | .1495 | 2-1/16" | 1" | 12 | \$1.35 |
| 210SM0026 | 26 | .1470 | 2-1/16" | 1" | 12 | \$1.35 |
| 210SM0027 | 27 | .1440 | 2-1/16" | 1" | 12 | \$1.35 |
| 210SM0028 | 28 | .1405 | 1-15/16" | 15/16" | 12 | \$1.17 |
| 210SM0029 | 29 | .1360 | 1-15/16" | 15/16" | 12 | \$1.17 |
| 210SM0030 | 30 | .1285 | 1-15/16" | 15/16" | 12 | \$1.17 |
| 210SM0031 | 31 | .1200 | 1-7/8" | 7/8" | 12 | \$1.17 |
| 210SM0032 | 32 | .1160 | 1-7/8" | 7/8" | 12 | \$1.17 |
| 210SM0033 | 33 | .1130 | 1-7/8" | 7/8" | 12 | \$1.17 |
| 210SM0034 | 34 | .1110 | 1-7/8" | 7/8" | 12 | \$1.17 |
| 210SM0035 | 35 | .1100 | 1-7/8" | 7/8" | 12 | \$1.17 |
| 210SM0036 | 36 | .1065 | 1-13/16" | 13/16" | 12 | \$1.17 |
| 210SM0037 | 37 | .1040 | 1-13/16" | 13/16" | 12 | \$1.17 |
| 210SM0038 | 38 | .1015 | 1-13/16" | 13/16" | 12 | \$1.17 |
| 210SM0039 | 39 | .0995 | 1-13/16" | 13/16" | 12 | \$1.17 |
| 210SM0040 | 40 | .0980 | 1-13/16" | 13/16" | 12 | \$1.17 |



Silver & Deming - 1/2" Shank - M2 HSS

| Part # | Size | Dec. | OAL | Flute | Qty. | List | Part # | Size | Dec. | OAL | Flute | Qty. | List |
|-----------|--------|-------|-----|--------|------|---------|-----------|---------|--------|-----|--------|------|----------|
| 201SD3364 | 33/64" | .5156 | 6" | 2-3/4" | 1 | \$14.44 | 201SD5364 | 53/64" | .8281 | 6" | 2-3/4" | 1 | \$26.78 |
| 201SD3464 | 17/32" | .5312 | 6" | 2-3/4" | 1 | \$14.67 | 201SD5464 | 27/32" | .8438 | 6" | 2-3/4" | 1 | \$27.03 |
| 201SD3564 | 35/64" | .5469 | 6" | 2-3/4" | 1 | \$14.89 | 201SD5564 | 55/64" | .8594 | 6" | 2-3/4" | 1 | \$27.65 |
| 201SD3664 | 9/16" | .5625 | 6" | 2-3/4" | 1 | \$14.89 | 201SD5664 | 7/8" | .8750 | 6" | 2-3/4" | 1 | \$27.65 |
| 201SD3764 | 37/64" | .5781 | 6" | 2-3/4" | 1 | \$16.67 | 201SD5764 | 57/64" | .8906 | 6" | 2-3/4" | 1 | \$30.49 |
| 201SD3864 | 19/32" | .5938 | 6" | 2-3/4" | 1 | \$16.67 | 201SD5864 | 29/32" | .9062 | 6" | 2-3/4" | 1 | \$30.49 |
| 201SD3964 | 39/64" | .6094 | 6" | 2-3/4" | 1 | \$16.90 | 201SD5964 | 59/64" | .9219 | 6" | 2-3/4" | 1 | \$30.80 |
| 201SD4064 | 5/8" | .6250 | 6" | 2-3/4" | 1 | \$16.90 | 201SD6064 | 15/16" | .9375 | 6" | 2-3/4" | 1 | \$30.80 |
| 201SD4164 | 41/64" | .6406 | 6" | 2-3/4" | 1 | \$18.05 | 201SD6164 | 61/64" | .9531 | 6" | 2-3/4" | 1 | \$33.15 |
| 201SD4264 | 21/32" | .6562 | 6" | 2-3/4" | 1 | \$18.05 | 201SD6264 | 31/32" | .9688 | 6" | 2-3/4" | 1 | \$33.15 |
| 201SD4364 | 43/64" | .6719 | 6" | 2-3/4" | 1 | \$18.84 | 201SD6364 | 63/64" | .9844 | 6" | 2-3/4" | 1 | \$35.35 |
| 201SD4464 | 11/16" | .6875 | 6" | 2-3/4" | 1 | \$21.67 | 201SD6464 | 1" | 1.0000 | 6" | 2-3/4" | 1 | \$38.89 |
| 201SD4564 | 45/64" | .7031 | 6" | 2-3/4" | 1 | \$22.81 | 201SD6864 | 1-1/16" | 1.0625 | 6" | 2-3/4" | 1 | \$57.78 |
| 201SD4664 | 23/32" | .7188 | 6" | 2-3/4" | 1 | \$22.81 | 201SD7264 | 1-1/8" | 1.1250 | 6" | 2-3/4" | 1 | \$60.60 |
| 201SD4764 | 47/64" | .7344 | 6" | 2-3/4" | 1 | \$23.50 | 201SD7664 | 1-3/16" | 1.1875 | 6" | 2-3/4" | 1 | \$72.28 |
| 201SD4864 | 3/4" | .7500 | 6" | 2-3/4" | 1 | \$23.50 | 201SD8064 | 1-1/4" | 1.2500 | 6" | 2-3/4" | 1 | \$83.70 |
| 201SD4964 | 49/64" | .7656 | 6" | 2-3/4" | 1 | \$25.21 | 201SD8464 | 1-5/16" | 1.3125 | 6" | 2-3/4" | 1 | \$87.90 |
| 201SD5064 | 25/32" | .7812 | 6" | 2-3/4" | 1 | \$25.21 | 201SD8864 | 1-3/8" | 1.3750 | 6" | 2-3/4" | 1 | \$95.50 |
| 201SD5164 | 51/64" | .7969 | 6" | 2-3/4" | 1 | \$25.64 | 201SD9664 | 1-1/2" | 1.5000 | 6" | 2-3/4" | 1 | \$106.55 |
| 201SD5264 | 13/16" | .8125 | 6" | 2-3/4" | 1 | \$25.64 | | | | | | | |

- ◆ 6" Length
- ◆ 118° Point
- ◆ Ground Flute
- ◆ 1/2" Shank
- ◆ Black Oxide Finish
- ◆ M2 HSS

- Cast Iron
- Steel
- Steel Forging
- Light to Medium Materials

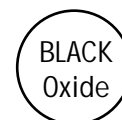

Silver & Deming - 3/8" Shank - M2 HSS

| Part # | Size | Dec. | OAL | Flute | Qty. | List | Part # | Size | Dec. | OAL | Flute | Qty. | List |
|-----------|--------|-------|-----|--------|------|---------|-----------|--------|-------|-----|--------|------|---------|
| 201R83364 | 33/64" | .5156 | 6" | 2-3/4" | 1 | \$26.13 | 201R84164 | 41/64" | .6406 | 6" | 2-3/4" | 1 | \$32.06 |
| 201R83464 | 17/32" | .5312 | 6" | 2-3/4" | 1 | \$26.76 | 201R84264 | 21/32" | .6562 | 6" | 2-3/4" | 1 | \$32.06 |
| 201R83564 | 35/64" | .5469 | 6" | 2-3/4" | 1 | \$27.72 | 201R84364 | 43/64" | .6719 | 6" | 2-3/4" | 1 | \$32.90 |
| 201R83664 | 9/16" | .5625 | 6" | 2-3/4" | 1 | \$27.72 | 201R84464 | 11/16" | .6875 | 6" | 2-3/4" | 1 | \$33.57 |
| 201R83764 | 37/64" | .5781 | 6" | 2-3/4" | 1 | \$29.91 | 201R84564 | 45/64" | .7031 | 6" | 2-3/4" | 1 | \$35.79 |
| 201R83864 | 19/32" | .5938 | 6" | 2-3/4" | 1 | \$29.91 | 201R84664 | 23/32" | .7188 | 6" | 2-3/4" | 1 | \$38.00 |
| 201R83964 | 39/64" | .6094 | 6" | 2-3/4" | 1 | \$29.91 | 201R84764 | 47/64" | .7344 | 6" | 2-3/4" | 1 | \$40.51 |
| 201R84064 | 5/8" | .6250 | 6" | 2-3/4" | 1 | \$30.78 | 201R84864 | 3/4" | .7500 | 6" | 2-3/4" | 1 | \$43.91 |

- ◆ 6" Length
- ◆ 118° Point
- ◆ Ground Flute
- ◆ 1/2" Shank
- ◆ Black Oxide Finish
- ◆ M2 HSS

- Cast Iron
- Steel
- Steel Forging
- Light to Medium Materials



INTERNATIONAL TOOL MANUFACTURING

(718) 446-0711 • (800) 247-5696

Fax (718) 899-6553

100% LAB TESTED

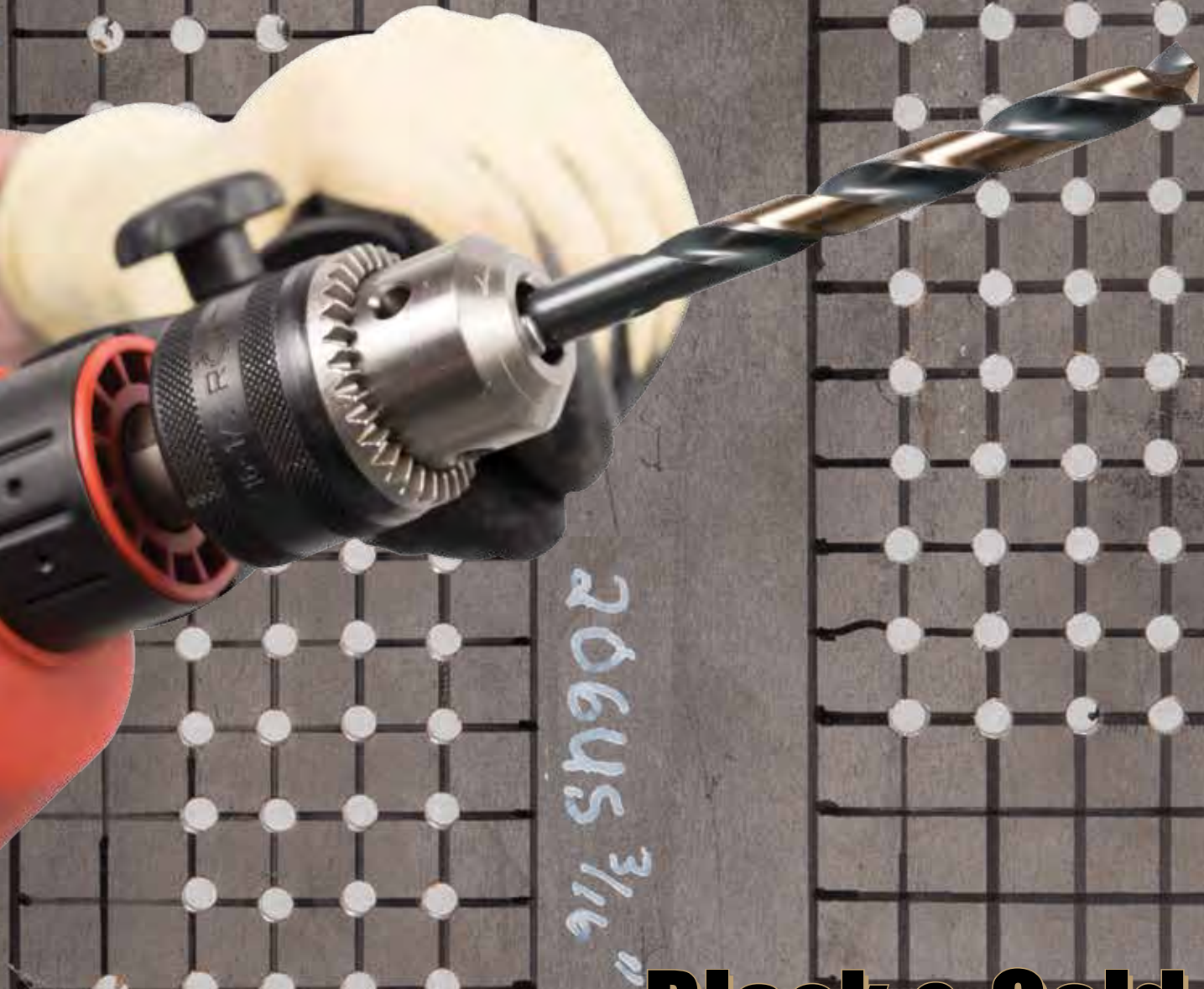

20645 3/16"

Black & Gold

The Most Recognizable Finish Anywhere.



- ◆ Jobber Length
- ◆ 135° Split Point
- ◆ Ground Flute
- ◆ Straight Shank
- ◆ Heavy Duty Web
- ◆ Black & Gold Finish
- ◆ M2 HSS

- Cast Iron
- Steel
- Steel Forging
- Stainless Steel

Black & Gold Jobber Drills - HEAVY DUTY - M2 HSS

| Part # | Size | Dec. | OAL | Flute | Qty. | List | Part # | Size | Dec. | OAL | Flute | Qty. | List |
|-----------|--------|-------|--------|----------|------|--------|-----------|--------|-------|--------|----------|------|---------|
| 206US0464 | 1/16" | .0625 | 1-7/8" | 7/8" | 12 | \$1.39 | 206US1964 | 19/64" | .2969 | 4-3/8" | 3-1/16" | 12 | \$4.96 |
| 206US0564 | 5/64" | .0781 | 2" | 1" | 12 | \$1.39 | 206US2064 | 5/16" | .3125 | 4-1/2" | 3-3/16" | 12 | \$5.14 |
| 206US0664 | 3/32" | .0938 | 2-1/4" | 1-1/4" | 12 | \$1.39 | 206US2164 | 21/64" | .3281 | 4-5/8" | 3-5/16" | 6 | \$5.67 |
| 206US0764 | 7/64" | .1094 | 2-5/8" | 1-1/2" | 12 | \$1.39 | 206US2264 | 11/32" | .3438 | 4-3/4" | 3-7/16" | 6 | \$6.35 |
| 206US0864 | 1/8" | .1250 | 2-3/4" | 1-5/8" | 12 | \$1.55 | 206US2364 | 23/64" | .3594 | 4-7/8" | 3-1/2" | 6 | \$7.22 |
| 206US0964 | 9/64" | .1406 | 2-7/8" | 1-3/4" | 12 | \$1.66 | 206US2464 | 3/8" | .3750 | 5" | 3-5/8" | 6 | \$7.42 |
| 206US1064 | 5/32" | .1562 | 3-1/8" | 2" | 12 | \$1.74 | 206US2564 | 25/64" | .3906 | 5-1/8" | 3-3/4" | 6 | \$8.50 |
| 206US1164 | 11/64" | .1719 | 3-1/4" | 2-1/8" | 12 | \$1.97 | 206US2664 | 13/32" | .4062 | 5-1/4" | 3-7/8" | 6 | \$9.63 |
| 206US1264 | 3/16" | .1875 | 3-1/2" | 2-5/16" | 12 | \$2.14 | 206US2764 | 27/64" | .4219 | 5-3/8" | 3-15/16" | 6 | \$10.82 |
| 206US1364 | 13/64" | .2031 | 3-5/8" | 2-7/16" | 12 | \$2.53 | 206US2864 | 7/16" | .4375 | 5-1/2" | 4-1/16" | 6 | \$12.14 |
| 206US1464 | 7/32" | .2188 | 3-3/4" | 2-1/2" | 12 | \$2.58 | 206US2964 | 29/64" | .4531 | 5-5/8" | 4-3/16" | 6 | \$12.77 |
| 206US1564 | 15/64" | .2344 | 3-7/8" | 2-5/8" | 12 | \$2.94 | 206US3064 | 15/32" | .4688 | 5-3/4" | 4-5/16" | 6 | \$13.19 |
| 206US1664 | 1/4" | .2500 | 4" | 2-3/4" | 12 | \$3.37 | 206US3164 | 31/64" | .4844 | 5-7/8" | 4-3/8" | 6 | \$15.38 |
| 206US1764 | 17/64" | .2656 | 4-1/8" | 2-7/8" | 12 | \$3.71 | 206US3264 | 1/2" | .5000 | 6" | 4-1/2" | 6 | \$16.04 |
| 206US1864 | 9/32" | .2812 | 4-1/4" | 2-15/16" | 12 | \$4.59 | | | | | | | |

Black & Gold Wire Gauge Drills - HEAVY DUTY - M2 HSS

| Part # | Size | Dec. | OAL | Flute | Qty. | List | Part # | Size | Dec. | OAL | Flute | Qty. | List |
|----------|------|-------|--------|---------|------|--------|----------|------|-------|--------|---------|------|--------|
| 207US-01 | 1 | .2280 | 3-7/8" | 2-5/8" | 12 | \$2.80 | 207US-31 | 31 | .1200 | 2-3/4" | 1-5/8" | 12 | \$1.60 |
| 207US-02 | 2 | .2210 | 3-7/8" | 2-5/8" | 12 | \$2.80 | 207US-32 | 32 | .1160 | 2-3/4" | 1-5/8" | 12 | \$1.55 |
| 207US-03 | 3 | .2130 | 3-3/4" | 2-1/2" | 12 | \$2.80 | 207US-33 | 33 | .1130 | 2-5/8" | 1-1/2" | 12 | \$1.55 |
| 207US-04 | 4 | .2090 | 3-3/4" | 2-1/2" | 12 | \$2.80 | 207US-34 | 34 | .1110 | 2-5/8" | 1-1/2" | 12 | \$1.55 |
| 207US-05 | 5 | .2055 | 3-3/4" | 2-1/2" | 12 | \$2.80 | 207US-35 | 35 | .1100 | 2-5/8" | 1-1/2" | 12 | \$1.55 |
| 207US-06 | 6 | .2040 | 3-3/4" | 2-1/2" | 12 | \$2.80 | 207US-36 | 36 | .1065 | 2-1/2" | 1-7/16" | 12 | \$1.55 |
| 207US-07 | 7 | .2010 | 3-5/8" | 2-7/16" | 12 | \$2.46 | 207US-37 | 37 | .1040 | 2-1/2" | 1-7/16" | 12 | \$1.55 |
| 207US-08 | 8 | .1990 | 3-5/8" | 2-7/16" | 12 | \$2.46 | 207US-38 | 38 | .1015 | 2-1/2" | 1-7/16" | 12 | \$1.55 |
| 207US-09 | 9 | .1960 | 3-5/8" | 2-7/16" | 12 | \$2.46 | 207US-39 | 39 | .0995 | 2-3/8" | 1-3/8" | 12 | \$1.55 |
| 207US-10 | 10 | .1935 | 3-5/8" | 2-7/16" | 12 | \$2.46 | 207US-40 | 40 | .0980 | 2-3/8" | 1-3/8" | 12 | \$1.55 |
| 207US-11 | 11 | .1910 | 3-1/2" | 2-5/16" | 12 | \$2.25 | 207US-41 | 41 | .0960 | 2-3/8" | 1-3/8" | 12 | \$1.45 |
| 207US-12 | 12 | .1890 | 3-1/2" | 2-5/16" | 12 | \$2.25 | 207US-42 | 42 | .0935 | 2-1/4" | 1-1/4" | 12 | \$1.45 |
| 207US-13 | 13 | .1850 | 3-1/2" | 2-5/16" | 12 | \$2.25 | 207US-43 | 43 | .0890 | 2-1/4" | 1-1/4" | 12 | \$1.45 |
| 207US-14 | 14 | .1820 | 3-3/8" | 2-3/16" | 12 | \$2.25 | 207US-44 | 44 | .0860 | 2-1/8" | 1-1/8" | 12 | \$1.45 |
| 207US-15 | 15 | .1800 | 3-3/8" | 2-3/16" | 12 | \$2.25 | 207US-45 | 45 | .0820 | 2-1/8" | 1-1/8" | 12 | \$1.45 |
| 207US-16 | 16 | .1770 | 3-3/8" | 2-3/16" | 12 | \$2.25 | 207US-46 | 46 | .0810 | 2-1/8" | 1-1/8" | 12 | \$1.45 |
| 207US-17 | 17 | .1730 | 3-3/8" | 2-3/16" | 12 | \$2.25 | 207US-47 | 47 | .0785 | 2" | 1" | 12 | \$1.45 |
| 207US-18 | 18 | .1695 | 3-1/4" | 2-1/8" | 12 | \$1.98 | 207US-48 | 48 | .0760 | 2" | 1" | 12 | \$1.45 |
| 207US-19 | 19 | .1660 | 3-1/4" | 2-1/8" | 12 | \$1.98 | 207US-49 | 49 | .0730 | 2" | 1" | 12 | \$1.45 |
| 207US-20 | 20 | .1610 | 3-1/4" | 2-1/8" | 12 | \$1.98 | 207US-50 | 50 | .0700 | 2" | 1" | 12 | \$1.45 |
| 207US-21 | 21 | .1590 | 3-1/4" | 2-1/8" | 12 | \$1.98 | 207US-51 | 51 | .0670 | 2" | 1" | 12 | \$1.45 |
| 207US-22 | 22 | .1570 | 3-1/8" | 2" | 12 | \$1.98 | 207US-52 | 52 | .0635 | 1-7/8" | 7/8" | 12 | \$1.45 |
| 207US-23 | 23 | .1540 | 3-1/8" | 2" | 12 | \$1.68 | 207US-53 | 53 | .0595 | 1-7/8" | 7/8" | 12 | \$1.45 |
| 207US-24 | 24 | .1520 | 3-1/8" | 2" | 12 | \$1.68 | 207US-54 | 54 | .0550 | 1-7/8" | 7/8" | 12 | \$1.45 |
| 207US-25 | 25 | .1495 | 3" | 1-7/8" | 12 | \$1.68 | 207US-55 | 55 | .0520 | 1-7/8" | 7/8" | 12 | \$1.45 |
| 207US-26 | 26 | .1470 | 3" | 1-7/8" | 12 | \$1.68 | 207US-56 | 56 | .0465 | 1-3/4" | 3/4" | 12 | \$1.45 |
| 207US-27 | 27 | .1440 | 3" | 1-7/8" | 12 | \$1.68 | 207US-57 | 57 | .0430 | 1-3/4" | 3/4" | 12 | \$1.45 |
| 207US-28 | 28 | .1405 | 2-7/8" | 1-3/4" | 12 | \$1.68 | 207US-58 | 58 | .0420 | 1-5/8" | 11/16" | 12 | \$1.45 |
| 207US-29 | 29 | .1360 | 2-7/8" | 1-3/4" | 12 | \$1.68 | 207US-59 | 59 | .0410 | 1-5/8" | 11/16" | 12 | \$1.45 |
| 207US-30 | 30 | .1285 | 2-3/4" | 1-5/8" | 12 | \$1.68 | 207US-60 | 60 | .0400 | 1-5/8" | 11/16" | 12 | \$1.45 |



NOTE:
SIZES 40 → 60
HAVE NO
SPLIT POINT.



Black & Gold Jobber Drills - HEAVY DUTY 3/8" Shank - M2 HSS

- ◆ Jobber Length
- ◆ 135° Split Point
- ◆ Ground Flute
- ◆ Straight Shank
- ◆ Heavy Duty Web
- ◆ Black & Gold Finish
- ◆ M2 HSS

| Part # | Size | Dec. | OAL | Flute | Qty. | List | Part # | Size | Dec. | OAL | Flute | Qty. | List |
|-----------|--------|-------|--------|----------|------|---------|-----------|--------|-------|--------|---------|------|---------|
| 206U82564 | 25/64" | .3906 | 5-1/8" | 3-3/4" | 6 | \$16.29 | 206U82964 | 29/64" | .4531 | 5-5/8" | 4-3/16" | 6 | \$21.12 |
| 206U82664 | 13/32" | .4062 | 5-1/4" | 3-1/8" | 6 | \$16.54 | 206U83064 | 15/32" | .4688 | 5-3/4" | 4-5/16" | 6 | \$21.55 |
| 206U82764 | 27/64" | .4219 | 5-3/8" | 3-15/16" | 6 | \$17.86 | 206U83164 | 31/64" | .4844 | 5-7/8" | 4-3/8" | 6 | \$22.24 |
| 206U82864 | 7/16" | .4375 | 5-1/2" | 4-1/16" | 6 | \$18.92 | 206U83264 | 1/2" | .5000 | 6" | 4-1/2" | 6 | \$22.87 |

- Cast Iron
- Steel
- Steel Forging
- Stainless Steel



Black & Gold Mechanics Length Drills - HEAVY DUTY - M2 HSS

- ◆ Mechanics Length
- ◆ 135° Split Point
- ◆ 3-Flat Shank (3/16" → 1/2")
- ◆ Black & Gold Finish
- ◆ Heavy Duty Web for Strength & Rigidity
- ◆ M2 HSS

| Part # | Size | Dec. | OAL | Flute | Qty. | List | Part # | Size | Dec. | OAL | Flute | Qty. | List |
|-----------|--------|-------|--------|----------|------|--------|-----------|--------|-------|---------|----------|------|---------|
| 208MC0464 | 1/16" | .0625 | 1 7/8" | 7/8" | 12 | \$1.60 | 208MC1964 | 19/64" | .2969 | 3-7/8" | 2-3/8" | 12 | \$6.08 |
| 208MC0564 | 5/64" | .0781 | 2" | 1" | 12 | \$1.60 | 208MC2064 | 5/16" | .3125 | 4" | 2-1/2" | 12 | \$6.17 |
| 208MC0664 | 3/32" | .0938 | 2-1/4" | 1-1/4" | 12 | \$1.75 | 208MC2164 | 21/64" | .3281 | 4-1/16" | 2-9/16" | 6 | \$6.95 |
| 208MC0764 | 7/64" | .1094 | 2-3/8" | 1-5/16" | 12 | \$1.75 | 208MC2264 | 11/32" | .3438 | 4-1/8" | 2-5/8" | 6 | \$7.58 |
| 208MC0864 | 1/8" | .1250 | 2-1/2" | 1-7/16" | 12 | \$1.85 | 208MC2364 | 23/64" | .3594 | 4-3/16" | 2-11/16" | 6 | \$8.02 |
| 208MC0964 | 9/64" | .1406 | 2-5/8" | 1-9/16" | 12 | \$1.94 | 208MC2464 | 3/8" | .3750 | 4-1/4" | 2-11/16" | 6 | \$8.31 |
| 208MC1064 | 5/32" | .1562 | 2-3/4" | 1-11/16" | 12 | \$2.43 | 208MC2564 | 25/64" | .3906 | 4-5/16" | 2-3/4" | 6 | \$9.55 |
| 208MC1164 | 11/64" | .1719 | 2-7/8" | 1-13/16" | 12 | \$2.53 | 208MC2664 | 13/32" | .4062 | 4-3/8" | 2-13/16" | 6 | \$9.90 |
| 208MC1264 | 3/16" | .1875 | 3" | 1-7/8" | 12 | \$3.21 | 208MC2764 | 27/64" | .4219 | 4-7/16" | 2-7/8" | 6 | \$10.54 |
| 208MC1364 | 13/64" | .2031 | 3-1/8" | 1-15/16" | 12 | \$3.40 | 208MC2864 | 7/16" | .4375 | 4-1/2" | 2-15/16" | 6 | \$11.48 |
| 208MC1464 | 7/32" | .2188 | 3-1/4" | 2" | 12 | \$3.60 | 208MC2964 | 29/64" | .4531 | 4-5/8" | 3" | 6 | \$13.12 |
| 208MC1564 | 15/64" | .2344 | 3-3/8" | 2" | 12 | \$3.84 | 208MC3064 | 15/32" | .4688 | 4-3/4" | 3-1/8" | 6 | \$13.86 |
| 208MC1664 | 1/4" | .2500 | 3-1/2" | 2" | 12 | \$4.03 | 208MC3164 | 31/64" | .4844 | 4-7/8" | 3-1/4" | 6 | \$13.91 |
| 208MC1764 | 17/64" | .2656 | 3-5/8" | 2-1/8" | 12 | \$4.33 | 208MC3264 | 1/2" | .5000 | 5" | 3-3/8" | 6 | \$14.85 |
| 208MC1864 | 9/32" | .2812 | 3-3/4" | 2-1/4" | 12 | \$5.25 | | | | | | | |

- Cast Iron
- Steel
- Steel Forging
- Stainless Steel



Black & Gold

- ◆ Jobber Length
- ◆ 135° Split Point
- ◆ Ground Flute
- ◆ Straight Shank
- ◆ Heavy Duty Web
- ◆ Black & Gold Finish
- ◆ M2 HSS

- Cast Iron
- Steel
- Steel Forging
- Stainless Steel

Black & Gold Letter Drills - HEAVY DUTY - M2 HSS

| Part # | Size | Dec. | OAL | Flute | Qty. | List | Part # | Size | Dec. | OAL | Flute | Qty. | List |
|---------|------|------|--------|----------|------|--------|---------|------|------|--------|---------|------|---------|
| 208US-A | A | .234 | 3-7/8" | 2-5/8" | 12 | \$4.38 | 208US-N | N | .302 | 4-3/8" | 3-1/16" | 6 | \$5.74 |
| 208US-B | B | .238 | 4" | 2-3/4" | 12 | \$4.38 | 208US-O | O | .316 | 4-1/2" | 3-3/16" | 6 | \$6.20 |
| 208US-C | C | .242 | 4" | 2-3/4" | 12 | \$4.38 | 208US-P | P | .323 | 4-5/8" | 3-5/16" | 6 | \$6.78 |
| 208US-D | D | .246 | 4" | 2-3/4" | 12 | \$4.38 | 208US-Q | Q | .332 | 4-3/4" | 3-7/16" | 6 | \$7.08 |
| 208US-E | E | .250 | 4" | 2-3/4" | 12 | \$4.38 | 208US-R | R | .339 | 4-3/4" | 3-7/16" | 6 | \$7.08 |
| 208US-F | F | .257 | 4-1/8" | 2-7/8" | 12 | \$4.58 | 208US-S | S | .348 | 4-7/8" | 3-1/2" | 6 | \$7.76 |
| 208US-G | G | .261 | 4-1/8" | 2-7/8" | 12 | \$4.58 | 208US-T | T | .358 | 4-7/8" | 3-1/2" | 6 | \$8.46 |
| 208US-H | H | .266 | 4-1/8" | 2-7/8" | 12 | \$4.58 | 208US-U | U | .368 | 5" | 3-5/8" | 6 | \$9.15 |
| 208US-I | I | .272 | 4-1/8" | 2-7/8" | 12 | \$5.01 | 208US-V | V | .377 | 5" | 3-5/8" | 6 | \$9.15 |
| 208US-J | J | .277 | 4-1/8" | 2-7/8" | 12 | \$5.01 | 208US-W | W | .386 | 5-1/8" | 3-3/4" | 6 | \$9.15 |
| 208US-K | K | .281 | 4-1/4" | 2-15/16" | 12 | \$5.01 | 208US-X | X | .397 | 5-1/8" | 3-3/4" | 6 | \$10.96 |
| 208US-L | L | .290 | 4-1/4" | 2-15/16" | 6 | \$5.59 | 208US-Y | Y | .404 | 5-1/4" | 3-7/8" | 6 | \$11.19 |
| 208US-M | M | .295 | 4-3/8" | 3-1/16" | 6 | \$5.74 | 208US-Z | Z | .413 | 5-1/4" | 3-7/8" | 6 | \$12.06 |



Black & Gold

- ◆ 6" Length
- ◆ 118° Split Point
- ◆ Ground Flute
- ◆ 3-Flat Round 1/2" Shank
- ◆ Heavy Duty Web
- ◆ Black & Gold Finish
- ◆ M2 HSS

- Cast Iron
- Steel
- Steel Forging
- Stainless Steel

Black & Gold Silver & Deming - 1/2" Shank - M2 HSS

| Part # | Size | Dec. | OAL | Flute | Qty. | List | Part # | Size | Dec. | OAL | Flute | Qty. | List |
|-----------|--------|-------|-----|--------|------|---------|-----------|---------|--------|-----|--------|------|---------|
| 201US3364 | 33/64" | .5156 | 6" | 2-3/4" | 1 | \$17.24 | 201US5164 | 51/64" | .7969 | 6" | 2-3/4" | 1 | \$32.04 |
| 201US3464 | 17/32" | .5312 | 6" | 2-3/4" | 1 | \$17.24 | 201US5264 | 13/16" | .8125 | 6" | 2-3/4" | 1 | \$32.04 |
| 201US3564 | 35/64" | .5469 | 6" | 2-3/4" | 1 | \$17.92 | 201US5364 | 53/64" | .8281 | 6" | 2-3/4" | 1 | \$33.04 |
| 201US3664 | 9/16" | .5625 | 6" | 2-3/4" | 1 | \$17.92 | 201US5464 | 27/32" | .8438 | 6" | 2-3/4" | 1 | \$33.04 |
| 201US3764 | 37/64" | .5781 | 6" | 2-3/4" | 1 | \$18.44 | 201US5564 | 55/64" | .8594 | 6" | 2-3/4" | 1 | \$35.40 |
| 201US3864 | 19/32" | .5938 | 6" | 2-3/4" | 1 | \$18.44 | 201US5664 | 7/8" | .8750 | 6" | 2-3/4" | 1 | \$35.40 |
| 201US3964 | 39/64" | .6094 | 6" | 2-3/4" | 1 | \$18.72 | 201US5764 | 57/64" | .8906 | 6" | 2-3/4" | 1 | \$35.90 |
| 201US4064 | 5/8" | .6250 | 6" | 2-3/4" | 1 | \$19.66 | 201US5864 | 29/32" | .9062 | 6" | 2-3/4" | 1 | \$35.90 |
| 201US4164 | 41/64" | .6406 | 6" | 2-3/4" | 1 | \$20.62 | 201US5964 | 59/64" | .9219 | 6" | 2-3/4" | 1 | \$37.60 |
| 201US4264 | 21/32" | .6562 | 6" | 2-3/4" | 1 | \$20.62 | 201US6064 | 15/16" | .9375 | 6" | 2-3/4" | 1 | \$37.60 |
| 201US4364 | 43/64" | .6719 | 6" | 2-3/4" | 1 | \$22.35 | 201US6164 | 61/64" | .9531 | 6" | 2-3/4" | 1 | \$39.88 |
| 201US4464 | 11/16" | .6875 | 6" | 2-3/4" | 1 | \$22.35 | 201US6264 | 31/32" | .9688 | 6" | 2-3/4" | 1 | \$39.88 |
| 201US4564 | 45/64" | .7031 | 6" | 2-3/4" | 1 | \$23.50 | 201US6364 | 63/64" | .9844 | 6" | 2-3/4" | 1 | \$42.04 |
| 201US4664 | 23/32" | .7188 | 6" | 2-3/4" | 1 | \$23.50 | 201US6464 | 1" | 1.0000 | 6" | 2-3/4" | 1 | \$42.04 |
| 201US4764 | 47/64" | .7344 | 6" | 2-3/4" | 1 | \$30.36 | 201US6864 | 1-1/16" | 1.0625 | 6 | 2-3/4" | 1 | \$58.72 |
| 201US4864 | 3/4" | .7500 | 6" | 2-3/4" | 1 | \$30.36 | 201US7264 | 1-1/8" | 1.1250 | 6 | 2-3/4" | 1 | \$62.13 |
| 201US4964 | 49/64" | .7656 | 6" | 2-3/4" | 1 | \$31.32 | 201US7664 | 1-3/16" | 1.1875 | 6 | 2-3/4" | 1 | \$68.95 |
| 201US5064 | 25/32" | .7812 | 6" | 2-3/4" | 1 | \$31.32 | 201US8064 | 1-1/4" | 1.2500 | 6 | 2-3/4" | 1 | \$83.70 |



Cobalt Jobber Drills - HEAVY DUTY - M35 COBALT

- ◆ Jobber Length
- ◆ 135° Split Point
- ◆ Ground Flute
- ◆ Straight Shank
- ◆ Heavy Duty Web
- ◆ Gold Finish
- ◆ M35 Cobalt
- ➔ Hardened Steel
- ➔ Stainless Steel
- ➔ High Temp Alloys
- ➔ Heat Treated Materials
- ➔ Abrasive Plastics

| Part # | Size | Dec. | OAL | Flute | Qty. | List | Part # | Size | Dec. | OAL | Flute | Qty. | List |
|-----------|--------|-------|--------|----------|------|--------|-----------|--------|-------|--------|----------|------|---------|
| 219CO0464 | 1/16" | .0625 | 1-7/8" | 7/8" | 12 | \$1.67 | 219CO1964 | 19/64" | .2969 | 4-3/8" | 3-1/16" | 12 | \$7.63 |
| 219CO0564 | 5/64" | .0781 | 2" | 1" | 12 | \$1.85 | 219CO2064 | 5/16" | .3125 | 4-1/2" | 3-3/16" | 12 | \$8.18 |
| 219CO0664 | 3/32" | .0938 | 2-1/4" | 1-1/4" | 12 | \$2.01 | 219CO2164 | 21/64" | .3281 | 4-5/8" | 3-5/16" | 6 | \$8.98 |
| 219CO0764 | 7/64" | .1094 | 2-5/8" | 1-1/2" | 12 | \$2.13 | 219CO2264 | 11/32" | .3438 | 4-3/4" | 3-7/16" | 6 | \$10.39 |
| 219CO0864 | 1/8" | .1250 | 2-3/4" | 1-5/8" | 12 | \$2.42 | 219CO2364 | 23/64" | .3594 | 4-7/8" | 3-1/2" | 6 | \$11.81 |
| 219CO0964 | 9/64" | .1406 | 2-7/8" | 1-3/4" | 12 | \$2.59 | 219CO2464 | 3/8" | .3750 | 5" | 3-5/8" | 6 | \$12.39 |
| 219CO1064 | 5/32" | .1562 | 3-1/8" | 2" | 12 | \$2.86 | 219CO2564 | 25/64" | .3906 | 5-1/8" | 3-3/4" | 6 | \$13.45 |
| 219CO1164 | 11/64" | .1719 | 3-1/4" | 2-1/8" | 12 | \$3.03 | 219CO2664 | 13/32" | .4062 | 5-1/4" | 3-7/8" | 6 | \$14.37 |
| 219CO1264 | 3/16" | .1875 | 3-1/2" | 2-5/16" | 12 | \$3.32 | 219CO2764 | 27/64" | .4219 | 5-3/8" | 3-15/16" | 6 | \$15.19 |
| 219CO1364 | 13/64" | .2031 | 3-5/8" | 2-7/16" | 12 | \$4.39 | 219CO2864 | 7/16" | .4375 | 5-1/2" | 4-1/16" | 6 | \$15.80 |
| 219CO1464 | 7/32" | .2188 | 3-3/4" | 2-1/2" | 12 | \$4.69 | 219CO2964 | 29/64" | .4531 | 5-5/8" | 4-3/16" | 6 | \$18.93 |
| 219CO1564 | 15/64" | .2344 | 3-7/8" | 2-5/8" | 12 | \$5.16 | 219CO3064 | 15/32" | .4688 | 5-3/4" | 4-5/16" | 6 | \$19.29 |
| 219CO1664 | 1/4" | .2500 | 4" | 2-3/4" | 12 | \$5.62 | 219CO3164 | 31/64" | .4844 | 5-7/8" | 4-3/8" | 6 | \$19.75 |
| 219CO1764 | 17/64" | .2656 | 4-1/8" | 2-7/8" | 12 | \$6.05 | 219CO3264 | 1/2" | .5000 | 6" | 4-1/2" | 6 | \$20.34 |
| 219CO1864 | 9/32" | .2812 | 4-1/4" | 2-15/16" | 12 | \$6.62 | | | | | | | |

Cobalt Wire Gauge Drills - HEAVY DUTY - M35 COBALT

| Part # | Size | Dec. | OAL | Flute | Qty. | List | Part # | Size | Dec. | OAL | Flute | Qty. | List |
|-----------|------|-------|--------|---------|------|--------|-----------|------|-------|--------|---------|------|--------|
| 220CO0001 | 1 | .2280 | 3-7/8" | 2-5/8" | 12 | \$5.21 | 220CO0031 | 31 | .1200 | 2-3/4" | 1-5/8" | 12 | \$2.52 |
| 220CO0002 | 2 | .2210 | 3-7/8" | 2-5/8" | 12 | \$5.21 | 220CO0032 | 32 | .1160 | 2-3/4" | 1-5/8" | 12 | \$2.52 |
| 220CO0003 | 3 | .2130 | 3-3/4" | 2-1/2" | 12 | \$5.21 | 220CO0033 | 33 | .1130 | 2-5/8" | 1-1/2" | 12 | \$2.52 |
| 220CO0004 | 4 | .2090 | 3-3/4" | 2-1/2" | 12 | \$5.21 | 220CO0034 | 34 | .1110 | 2-5/8" | 1-1/2" | 12 | \$2.52 |
| 220CO0005 | 5 | .2055 | 3-3/4" | 2-1/2" | 12 | \$5.21 | 220CO0035 | 35 | .1100 | 2-5/8" | 1-1/2" | 12 | \$2.52 |
| 220CO0006 | 6 | .2040 | 3-3/4" | 2-1/2" | 12 | \$5.21 | 220CO0036 | 36 | .1065 | 2-1/2" | 1-7/16" | 12 | \$2.52 |
| 220CO0007 | 7 | .2010 | 3-5/8" | 2-7/16" | 12 | \$3.95 | 220CO0037 | 37 | .1040 | 2-1/2" | 1-7/16" | 12 | \$2.52 |
| 220CO0008 | 8 | .1990 | 3-5/8" | 2-7/16" | 12 | \$3.95 | 220CO0038 | 38 | .1015 | 2-1/2" | 1-7/16" | 12 | \$2.52 |
| 220CO0009 | 9 | .1960 | 3-5/8" | 2-7/16" | 12 | \$3.95 | 220CO0039 | 39 | .0995 | 2-3/8" | 1-3/8" | 12 | \$2.52 |
| 220CO0010 | 10 | .1935 | 3-5/8" | 2-7/16" | 12 | \$3.95 | 220CO0040 | 40 | .0980 | 2-3/8" | 1-3/8" | 12 | \$2.52 |
| 220CO0011 | 11 | .1910 | 3-1/2" | 2-5/16" | 12 | \$3.95 | 220CO0041 | 41 | .0960 | 2-3/8" | 1-3/8" | 12 | \$2.52 |
| 220CO0012 | 12 | .1890 | 3-1/2" | 2-5/16" | 12 | \$3.95 | 220CO0042 | 42 | .0935 | 2-1/4" | 1-1/4" | 12 | \$2.52 |
| 220CO0013 | 13 | .1850 | 3-1/2" | 2-5/16" | 12 | \$3.95 | 220CO0043 | 43 | .0890 | 2-1/4" | 1-1/4" | 12 | \$2.52 |
| 220CO0014 | 14 | .1820 | 3-3/8" | 2-3/16" | 12 | \$3.95 | 220CO0044 | 44 | .0860 | 2-1/8" | 1-1/8" | 12 | \$2.52 |
| 220CO0015 | 15 | .1800 | 3-3/8" | 2-3/16" | 12 | \$3.95 | 220CO0045 | 45 | .0820 | 2-1/8" | 1-1/8" | 12 | \$2.52 |
| 220CO0016 | 16 | .1770 | 3-3/8" | 2-3/16" | 12 | \$3.95 | 220CO0046 | 46 | .0810 | 2-1/8" | 1-1/8" | 12 | \$2.52 |
| 220CO0017 | 17 | .1730 | 3-3/8" | 2-3/16" | 12 | \$3.95 | 220CO0047 | 47 | .0785 | 2" | 1" | 12 | \$2.52 |
| 220CO0018 | 18 | .1695 | 3-1/4" | 2-1/8" | 12 | \$3.95 | 220CO0048 | 48 | .0760 | 2" | 1" | 12 | \$2.52 |
| 220CO0019 | 19 | .1660 | 3-1/4" | 2-1/8" | 12 | \$2.93 | 220CO0049 | 49 | .0730 | 2" | 1" | 12 | \$2.52 |
| 220CO0020 | 20 | .1610 | 3-1/4" | 2-1/8" | 12 | \$2.93 | 220CO0050 | 50 | .0700 | 2" | 1" | 12 | \$2.52 |
| 220CO0021 | 21 | .1590 | 3-1/4" | 2-1/8" | 12 | \$2.93 | 220CO0051 | 51 | .0670 | 2" | 1" | 12 | \$2.52 |
| 220CO0022 | 22 | .1570 | 3-1/8" | 2" | 12 | \$2.93 | 220CO0052 | 52 | .0635 | 1-7/8" | 7/8" | 12 | \$2.52 |
| 220CO0023 | 23 | .1540 | 3-1/8" | 2" | 12 | \$2.93 | 220CO0053 | 53 | .0595 | 1-7/8" | 7/8" | 12 | \$2.52 |
| 220CO0024 | 24 | .1520 | 3-1/8" | 2" | 12 | \$2.93 | 220CO0054 | 54 | .0550 | 1-7/8" | 7/8" | 12 | \$2.52 |
| 220CO0025 | 25 | .1495 | 3" | 1-7/8" | 12 | \$2.93 | 220CO0055 | 55 | .0520 | 1-7/8" | 7/8" | 12 | \$2.52 |
| 220CO0026 | 26 | .1470 | 3" | 1-7/8" | 12 | \$2.93 | 220CO0056 | 56 | .0465 | 1-3/4" | 3/4" | 12 | \$2.52 |
| 220CO0027 | 27 | .1440 | 3" | 1-7/8" | 12 | \$2.93 | 220CO0057 | 57 | .0430 | 1-3/4" | 3/4" | 12 | \$2.52 |
| 220CO0028 | 28 | .1405 | 2-7/8" | 1-3/4" | 12 | \$2.93 | 220CO0058 | 58 | .0420 | 1-5/8" | 11/16" | 12 | \$2.52 |
| 220CO0029 | 29 | .1360 | 2-7/8" | 1-3/4" | 12 | \$2.93 | 220CO0059 | 59 | .0410 | 1-5/8" | 11/16" | 12 | \$2.52 |
| 220CO0030 | 30 | .1285 | 2-3/4" | 1-5/8" | 12 | \$2.52 | 220CO0060 | 60 | .0400 | 1-5/8" | 11/16" | 12 | \$2.52 |



NOTE:
SIZES 40 → 60
HAVE NO
SPLIT POINT.



**135°
SPLIT
POINT**

Cobalt Jobber Drills - 3/8" Shank - M35 COBALT

| Part # | Size | Dec. | OAL | Flute | Qty. | List | Part # | Size | Dec. | OAL | Flute | Qty. | List |
|-----------|--------|-------|--------|----------|------|---------|-----------|--------|-------|--------|---------|------|---------|
| 219R82564 | 25/64" | .3906 | 5-1/8" | 3-3/4" | 6 | \$20.81 | 219R82964 | 29/64" | .4531 | 5-5/8" | 4-3/16" | 6 | \$28.43 |
| 219R82664 | 13/32" | .4062 | 5-1/4" | 3-1/8" | 6 | \$21.46 | 219R83064 | 15/32" | .4688 | 5-3/4" | 4-5/16" | 6 | \$28.82 |
| 219R82764 | 27/64" | .4219 | 5-3/8" | 3-15/16" | 6 | \$23.86 | 219R83164 | 31/64" | .4844 | 5-7/8" | 4-3/8" | 6 | \$29.69 |
| 219R82864 | 7/16" | .4375 | 5-1/2" | 4-1/16" | 6 | \$24.29 | 219R83264 | 1/2" | .5000 | 6" | 4-1/2" | 6 | \$29.85 |

◆ Same as 219CO with 3/8" Shank.



**135°
SPLIT
POINT**

Cobalt Stub Fractional - M35 COBALT

| Part # | Size | Dec. | OAL | Flute | Qty. | List | Part # | Size | Dec. | OAL | Flute | Qty. | List |
|----------|--------|-------|----------|---------|------|--------|----------|--------|-------|----------|----------|------|---------|
| CTS-0464 | 1/16" | .0625 | 1-5/8" | 5/8" | 12 | \$1.25 | CTS-1964 | 19/64" | .2969 | 2-3/4" | 1-9/16" | 12 | \$6.94 |
| CTS-0564 | 5/64" | .0781 | 1-11/16" | 11/16" | 12 | \$1.25 | CTS-2064 | 5/16" | .3125 | 2-13/16" | 1-5/8" | 12 | \$8.33 |
| CTS-0664 | 3/32" | .0938 | 1-3/4" | 3/4" | 12 | \$1.33 | CTS-2164 | 21/64" | .3281 | 2-15/16" | 1-11/16" | 6 | \$8.96 |
| CTS-0764 | 7/64" | .1094 | 1-13/16" | 13/16" | 12 | \$1.50 | CTS-2264 | 11/32" | .3438 | 3" | 1-11/16" | 6 | \$9.58 |
| CTS-0864 | 1/8" | .1250 | 1-7/8" | 7/8" | 12 | \$1.75 | CTS-2364 | 23/64" | .3594 | 3-1/16" | 1-3/4" | 6 | \$11.18 |
| CTS-0964 | 9/64" | .1406 | 1-15/16" | 15/16" | 12 | \$2.00 | CTS-2464 | 3/8" | .3750 | 3-1/8" | 1-13/16" | 6 | \$10.76 |
| CTS-1064 | 5/32" | .1562 | 2-1/16" | 1" | 12 | \$2.15 | CTS-2564 | 25/64" | .3906 | 3-1/4" | 1-7/8" | 6 | \$12.71 |
| CTS-1164 | 11/64" | .1719 | 2-1/8" | 1-1/16" | 12 | \$2.22 | CTS-2664 | 13/32" | .4062 | 3-5/16" | 1-15/16" | 6 | \$14.41 |
| CTS-1264 | 3/16" | .1875 | 2-3/16" | 1-1/8" | 12 | \$2.50 | CTS-2764 | 27/64" | .4219 | 3-3/8" | 2" | 6 | \$15.11 |
| CTS-1364 | 13/64" | .2031 | 2-1/4" | 1-3/16" | 12 | \$2.92 | CTS-2864 | 7/16" | .4375 | 3-7/16" | 2-1/16" | 6 | \$16.37 |
| CTS-1464 | 7/32" | .2188 | 2-3/8" | 1-1/4" | 12 | \$3.40 | CTS-2964 | 29/64" | .4531 | 3-9/16" | 2-1/8" | 6 | \$16.19 |
| CTS-1564 | 15/64" | .2344 | 2-7/16" | 1-5/16" | 12 | \$3.96 | CTS-3064 | 15/32" | .4688 | 3-5/8" | 2-1/8" | 6 | \$17.80 |
| CTS-1664 | 1/4" | .2500 | 2-1/2" | 1-3/8" | 12 | \$4.86 | CTS-3164 | 31/64" | .4844 | 3-11/16" | 2-3/16" | 6 | \$18.56 |
| CTS-1764 | 17/64" | .2656 | 2-5/8" | 1-7/16" | 12 | \$5.21 | CTS-3264 | 1/2" | .5000 | 3-3/4" | 2-1/4" | 6 | \$18.59 |
| CTS-1864 | 9/32" | .2812 | 2-11/16" | 1-1/2" | 12 | \$5.76 | | | | | | | |

- ◆ Stub Length
- ◆ 135° Split Point
- ◆ Ground Flute
- ◆ Straight Shank
- ◆ Heavy Duty Web
- ◆ Gold Finish
- ◆ M35 Cobalt

- Cast Iron
- Hardened Steel
- Stainless Steel
- Sheet Metal
- High Temp Alloys
- Heat Treated Materials
- Automotive



**118°
SPLIT
POINT**

Cobalt Silver & Deming - 1/2" Shank - M35 COBALT

| Part # | Size | Dec. | OAL | Flute | Qty. | List | Part # | Size | Dec. | OAL | Flute | Qty. | List |
|-----------|--------|-------|-----|--------|------|---------|-----------|---------|--------|-----|--------|------|----------|
| 201CO3464 | 17/32" | .5312 | 6 | 2-3/4" | 1 | \$36.19 | 201CO5864 | 29/32" | .9062 | 6 | 2-3/4" | 1 | \$72.38 |
| 201CO3664 | 9/16" | .5625 | 6 | 2-3/4" | 1 | \$41.71 | 201CO6064 | 15/16" | .9375 | 6 | 2-3/4" | 1 | \$77.28 |
| 201CO3864 | 19/32" | .5938 | 6 | 2-3/4" | 1 | \$44.16 | 201CO6264 | 31/32" | .9688 | 6 | 2-3/4" | 1 | \$87.98 |
| 201CO4064 | 5/8" | .6250 | 6 | 2-3/4" | 1 | \$46.62 | 201CO6464 | 1" | 1.0000 | 6 | 2-3/4" | 1 | \$90.78 |
| 201CO4264 | 21/32" | .6562 | 6 | 2-3/4" | 1 | \$49.69 | 201CO6864 | 1-1/16" | 1.0625 | 6 | 2-3/4" | 1 | \$109.92 |
| 201CO4464 | 11/16" | .6875 | 6 | 2-3/4" | 1 | \$52.13 | 201CO7264 | 1-1/8" | 1.1250 | 6 | 2-3/4" | 1 | \$125.10 |
| 201CO4664 | 23/32" | .7188 | 6 | 2-3/4" | 1 | \$54.59 | 201CO7664 | 1-3/16" | 1.1875 | 6 | 2-3/4" | 1 | \$143.05 |
| 201CO4864 | 3/4" | .7500 | 6 | 2-3/4" | 1 | \$57.05 | 201CO8064 | 1-1/4" | 1.2500 | 6 | 2-3/4" | 1 | \$166.16 |
| 201CO5064 | 25/32" | .7812 | 6 | 2-3/4" | 1 | \$59.49 | 201CO8464 | 1-5/16" | 1.3125 | 6 | 2-3/4" | 1 | \$174.07 |
| 201CO5264 | 13/16" | .8125 | 6 | 2-3/4" | 1 | \$63.79 | 201CO8864 | 1-3/8" | 1.3750 | 6 | 2-3/4" | 1 | \$179.45 |
| 201CO5464 | 27/32" | .8438 | 6 | 2-3/4" | 1 | \$66.24 | 201CO9664 | 1-1/2" | 1.5000 | 6 | 2-3/4" | 1 | \$201.07 |
| 201CO5664 | 7/8" | .8750 | 6 | 2-3/4" | 1 | \$68.70 | | | | | | | |

- ◆ 6" Length
- ◆ 118° Split Point
- ◆ Ground Flute
- ◆ 3-Flat Round 1/2" Shank
- ◆ Gold Finish
- ◆ M35 Cobalt

- Cast Iron
- Steel
- Steel Forging
- Stainless Steel



Titanium Jobber Drills - (TiN) Titanium Nitride Coating

- ◆ Jobber Length
- ◆ 135° Split Point
- ◆ Ground Flute
- ◆ Straight Shank
- ◆ Heavy Duty Web
- ◆ TiN Coating

- Cast Iron
- Steel
- Tool Steel
- Alloys

| Part # | Size | Dec. | OAL | Flute | Qty. | List | Part # | Size | Dec. | OAL | Flute | Qty. | List |
|-----------|--------|-------|--------|----------|------|--------|-----------|--------|-------|--------|----------|------|---------|
| 255SP0464 | 1/16" | .0625 | 1-7/8" | 7/8" | 12 | \$2.47 | 255SP1964 | 19/64" | .2969 | 4-3/8" | 3-1/16" | 12 | \$8.47 |
| 255SP0564 | 5/64" | .0781 | 2" | 1" | 12 | \$2.47 | 255SP2064 | 5/16" | .3125 | 4-1/2" | 3-3/16" | 12 | \$8.63 |
| 255SP0664 | 3/32" | .0938 | 2-1/4" | 1-1/4" | 12 | \$2.47 | 255SP2164 | 21/64" | .3281 | 4-5/8" | 3-5/16" | 6 | \$8.98 |
| 255SP0764 | 7/64" | .1094 | 2-5/8" | 1-1/2" | 12 | \$2.47 | 255SP2264 | 11/32" | .3438 | 4-3/4" | 3-7/16" | 6 | \$9.28 |
| 255SP0864 | 1/8" | .1250 | 2-3/4" | 1-5/8" | 12 | \$2.47 | 255SP2364 | 23/64" | .3594 | 4-7/8" | 3-1/2" | 6 | \$12.65 |
| 255SP0964 | 9/64" | .1406 | 2-7/8" | 1-3/4" | 12 | \$2.51 | 255SP2464 | 3/8" | .3750 | 5" | 3-5/8" | 6 | \$13.14 |
| 255SP1064 | 5/32" | .1562 | 3-1/8" | 2" | 12 | \$2.51 | 255SP2564 | 25/64" | .3906 | 5-1/8" | 3-3/4" | 6 | \$15.98 |
| 255SP1164 | 11/64" | .1719 | 3-1/4" | 2-1/8" | 12 | \$2.70 | 255SP2664 | 13/32" | .4062 | 5-1/4" | 3-7/8" | 6 | \$16.23 |
| 255SP1264 | 3/16" | .1875 | 3-1/2" | 2-5/16" | 12 | \$2.76 | 255SP2764 | 27/64" | .4219 | 5-3/8" | 3-15/16" | 6 | \$16.85 |
| 255SP1364 | 13/64" | .2031 | 3-5/8" | 2-7/16" | 12 | \$4.94 | 255SP2864 | 7/16" | .4375 | 5-1/2" | 4-1/16" | 6 | \$17.50 |
| 255SP1464 | 7/32" | .2188 | 3-3/4" | 2-1/2" | 12 | \$5.17 | 255SP2964 | 29/64" | .4531 | 5-5/8" | 4-3/16" | 6 | \$18.11 |
| 255SP1564 | 15/64" | .2344 | 3-7/8" | 2-5/8" | 12 | \$5.23 | 255SP3064 | 15/32" | .4688 | 5-3/4" | 4-5/16" | 6 | \$18.62 |
| 255SP1664 | 1/4" | .2500 | 4" | 2-3/4" | 12 | \$5.26 | 255SP3164 | 31/64" | .4844 | 5-7/8" | 4-3/8" | 6 | \$19.06 |
| 255SP1764 | 17/64" | .2656 | 4-1/8" | 2-7/8" | 12 | \$7.88 | 255SP3264 | 1/2" | .5000 | 6" | 4-1/2" | 6 | \$19.28 |
| 255SP1864 | 9/32" | .2812 | 4-1/4" | 2-15/16" | 12 | \$8.00 | | | | | | | |



Made In



Spotweld - Double End - M42 COBALT

| Part # | Size | Frac. | OAL | Qty. | List |
|-----------|---------|-------|--------|------|---------|
| 219DE0065 | 6.5 mm | 1/4" | 3-5/8" | 5 | \$21.99 |
| 219DE0080 | 8.0 mm | 5/16" | 3-5/8" | 5 | \$28.64 |
| 219DE0100 | 10.0 mm | 3/8" | 3-5/8" | 5 | \$42.83 |



Double End - M42 COBALT

| Part # | Size | Dec. | OAL | Flute | Qty. | List |
|-----------|------|-------|-----|-------|------|--------|
| 211CO0864 | 1/8" | .1250 | 2" | 1/2" | 12 | \$5.35 |
| 211CO0030 | #30 | .1285 | 2" | 1/2" | 12 | \$5.35 |

- ◆ Heavy Duty Spur
- ◆ M42 Super Cobalt
- ◆ High Red Hot Hardness
- ◆ Double End
- ◆ Gold Finish



Double End - M2 HSS BRIGHT

| Part # | Size | Dec. | OAL | Flute | Qty. | List |
|-----------|-------|-------|---------|-------|------|--------|
| 211DE0764 | 7/64" | .1094 | 1-7/8" | 1/2" | 12 | \$1.06 |
| 211DE0864 | 1/8" | .1250 | 2" | 1/2" | 12 | \$1.14 |
| 211DE0964 | 9/64" | .1406 | 2" | 1/2" | 12 | \$1.24 |
| 211DE1064 | 5/32" | .1562 | 2-1/16" | 1/2" | 12 | \$1.38 |
| 211DE1264 | 3/16" | .1875 | 2-3/16" | 1/2" | 12 | \$1.89 |
| 211DE1464 | 7/32" | .2188 | 2-3/8" | 1/2" | 12 | \$2.72 |
| 211DE1664 | 1/4" | .2500 | 2-1/2" | 1/2" | 12 | \$2.98 |
| 211DE0030 | #30 | .1285 | 2" | 1/2" | 12 | \$1.20 |



Double End - M2 HSS BLACK

| Part # | Size | Dec. | OAL | Flute | Qty. | List |
|-------------|------|-------|-----|-------|------|--------|
| 211DE0864-B | 1/8" | .1250 | 2" | 1/2" | 12 | \$1.17 |
| 211DE0030-B | #30 | .1285 | 2" | 1/2" | 12 | \$1.24 |

- ◆ Heavy Duty
 - ◆ 135° Split Point
 - ◆ M2 HSS
 - ◆ Bright and Black Finish
- Sheet Metal
 - Automotive



6" Cobalt Aircraft - M35 COBALT

| Part # | Size | Dec. | OAL | Flute | Qty. | List |
|-----------|--------|-------|-----|---------|------|---------|
| 212CO0464 | 1/16" | .0625 | 6" | 7/8" | 6 | \$6.80 |
| 212CO0864 | 1/8" | .1250 | 6" | 1-5/8" | 6 | \$6.72 |
| 212CO1064 | 5/32" | .1562 | 6" | 2" | 6 | \$6.80 |
| 212CO1164 | 11/64" | .1719 | 6" | 2-1/8" | 6 | \$8.17 |
| 212CO1264 | 3/16" | .1875 | 6" | 2-5/16" | 6 | \$8.17 |
| 212CO1464 | 7/32" | .2188 | 6" | 2-1/2" | 6 | \$10.16 |
| 212CO1664 | 1/4" | .2500 | 6" | 2-3/4" | 6 | \$12.61 |
| 212CO2064 | 5/16" | .3125 | 6" | 3-3/16" | 1 | \$24.53 |
| 212CO2464 | 3/8" | .3750 | 6" | 3-5/8" | 1 | \$30.99 |

- ◆ Straight Shank
- ◆ 135° Split Point
- ◆ Ground Flute
- ◆ Extra Flexibility
- ◆ Heavy Duty Web
- ◆ Gold Finish
- ◆ M35 Cobalt



- Steel
- Stainless Steel
- Heat Treated Materials



6" Aircraft - M2 HSS

| Part # | Size | Dec. | OAL | Flute | Qty. | List |
|-----------|--------|-------|-----|----------|------|---------|
| 212SP0464 | 1/16" | .0625 | 6" | 7/8" | 6 | \$4.49 |
| 212SP0864 | 1/8" | .1250 | 6" | 1-5/8" | 6 | \$4.49 |
| 212SP0964 | 9/64" | .1406 | 6" | 1-3/4" | 6 | \$4.49 |
| 212SP1064 | 5/32" | .1562 | 6" | 2" | 6 | \$4.49 |
| 212SP1164 | 11/64" | .1719 | 6" | 2-1/8" | 6 | \$4.78 |
| 212SP1264 | 3/16" | .1875 | 6" | 2-5/16" | 6 | \$5.13 |
| 212SP1364 | 13/64" | .2031 | 6" | 2-7/16" | 6 | \$6.04 |
| 212SP1464 | 7/32" | .2188 | 6" | 2-1/2" | 6 | \$6.36 |
| 212SP1564 | 15/64" | .2344 | 6" | 2-5/8" | 6 | \$6.76 |
| 212SP1664 | 1/4" | .2500 | 6" | 2-3/4" | 6 | \$7.88 |
| 212SP1764 | 17/64" | .2656 | 6" | 2-7/8" | 6 | \$8.35 |
| 212SP1864 | 9/32" | .2812 | 6" | 2-15/16" | 6 | \$9.08 |
| 212SP2064 | 5/16" | .3125 | 6" | 3-3/16" | 1 | \$9.56 |
| 212SP2264 | 11/32" | .3438 | 6" | 3-7/16" | 1 | \$12.31 |
| 212SP2464 | 3/8" | .3750 | 6" | 3-5/8" | 1 | \$14.88 |
| 212SP2864 | 7/16" | .4375 | 6" | 4-1/16" | 1 | \$18.44 |
| 212SP3264 | 1/2" | .5000 | 6" | 4-1/2" | 1 | \$22.17 |

18" Aircraft - M2 HSS

| Part # | Size | Dec. | OAL | Flute | Qty. | List |
|-----------|-------|-------|-----|---------|------|---------|
| 215SP1264 | 3/16" | .1875 | 18" | 2-5/16" | 1 | \$17.13 |
| 215SP1664 | 1/4" | .2500 | 18" | 2-3/4" | 1 | \$18.90 |
| 215SP2064 | 5/16" | .3125 | 18" | 3-3/16" | 1 | \$33.50 |
| 215SP2464 | 3/8" | .3750 | 18" | 3-5/8" | 1 | \$35.67 |
| 215SP3264 | 1/2" | .5000 | 18" | 4-1/2" | 1 | \$49.47 |

6" Wire Gauge Aircraft - M2 HSS

| Part # | Size | Dec. | OAL | Flute | Qty. | List |
|-----------|------|-------|-----|---------|------|--------|
| 213SP0001 | 1 | .2280 | 6" | 2-5/8" | 6 | \$6.26 |
| 213SP0002 | 2 | .2210 | 6" | 2-5/8" | 6 | \$6.26 |
| 213SP0007 | 7 | .2010 | 6" | 2-7/16" | 6 | \$6.26 |
| 213SP0009 | 9 | .1960 | 6" | 2-7/16" | 6 | \$6.26 |
| 213SP0010 | 10 | .1935 | 6" | 2-7/16" | 6 | \$5.23 |
| 213SP0011 | 11 | .1910 | 6" | 2-5/16" | 6 | \$5.23 |
| 213SP0016 | 16 | .1770 | 6" | 2-3/16" | 6 | \$5.23 |
| 213SP0017 | 17 | .1730 | 6" | 2-3/16" | 6 | \$5.23 |
| 213SP0021 | 21 | .1590 | 6" | 2-1/8" | 6 | \$5.22 |
| 213SP0026 | 26 | .1470 | 6" | 1-7/8" | 6 | \$5.22 |
| 213SP0029 | 29 | .1360 | 6" | 1-3/4" | 6 | \$5.22 |
| 213SP0030 | 30 | .1285 | 6" | 1-5/8" | 6 | \$3.89 |
| 213SP0031 | 31 | .1200 | 6" | 1-5/8" | 6 | \$3.89 |
| 213SP0040 | 40 | .0980 | 6" | 1-3/8" | 6 | \$5.27 |

12" Aircraft - M2 HSS

| Part # | Size | Dec. | OAL | Flute | Qty. | List |
|------------|--------|-------|-----|----------|------|---------|
| 214SP0864 | 1/8" | .1250 | 12" | 1-5/8" | 1 | \$6.33 |
| 214SP1064 | 5/32" | .1562 | 12" | 2" | 1 | \$7.39 |
| 214SP1264 | 3/16" | .1875 | 12" | 2-5/16" | 1 | \$11.67 |
| 214SP1464 | 7/32" | .2188 | 12" | 2-1/2" | 1 | \$14.89 |
| 214SP1664 | 1/4" | .2500 | 12" | 2-3/4" | 1 | \$16.33 |
| 214SP1864 | 9/32" | .2812 | 12" | 2-15/16" | 1 | \$21.75 |
| 214SP2064 | 5/16" | .3125 | 12" | 3-3/16" | 1 | \$23.39 |
| 214SP2264 | 11/32" | .3438 | 12" | 3-7/16" | 1 | \$24.83 |
| 214SP2464 | 3/8" | .3750 | 12" | 3-5/8" | 1 | \$26.94 |
| 214SP2864* | 7/16" | .4375 | 12" | 4-1/16" | 1 | \$35.83 |
| 214SP3264* | 1/2" | .5000 | 12" | 4-1/2" | 1 | \$43.39 |

* 3/8" Shank

12" Wire Gauge Aircraft - M2 HSS

| Part # | Size | Dec. | OAL | Flute | Qty. | List |
|-----------|------|-------|-----|---------|------|---------|
| 213SP1201 | 1 | .2280 | 12" | 2-5/8" | 1 | \$17.95 |
| 213SP1207 | 7 | .2010 | 12" | 2-7/16" | 1 | \$13.78 |
| 213SP1210 | 10 | .1935 | 12" | 2-7/16" | 1 | \$13.78 |
| 213SP1221 | 21 | .1590 | 12" | 2-1/8" | 1 | \$10.48 |
| 213SP1229 | 29 | .1360 | 12" | 1-3/4" | 1 | \$7.00 |
| 213SP1230 | 30 | .1285 | 12" | 1-5/8" | 1 | \$7.00 |
| 213SP1231 | 31 | .1200 | 12" | 1-5/8" | 1 | \$7.00 |
| 213SP1240 | 40 | .0980 | 12" | 1-3/8" | 1 | \$7.60 |

- ◆ Straight Shank
- ◆ 135° Split Point
- ◆ Ground Flute
- ◆ Extra Flexibility
- ◆ Heavy Duty Web
- ◆ Black Oxide Finish
- ◆ M2 HSS

- Steel
- Medium Alloys



3-Flat, No-Slip Shank

Made in U.S.A.



Made In



- ◆ Jobber Length
- ◆ 135° Split Point
- ◆ Ground Flute
- ◆ 3-Flat Shank
- ◆ Heavy Duty Web for Strength & Rigidity
- ◆ Black & Gold Finish
- ◆ M2 HSS

- Cast Iron
- Steel
- Steel Forging
- Stainless Steel

MRO Black and Gold Jobber Drills - SUPER HEAVY DUTY

| Part # | Size | Dec. | OAL | Flute | Qty. | List | Part # | Size | Dec. | OAL | Flute | Qty. | List |
|----------|--------|-------|--------|----------|------|--------|----------|--------|-------|--------|----------|------|---------|
| MRO-0464 | 1/16" | .0625 | 1-7/8" | 7/8" | 12 | \$1.97 | MRO-1964 | 19/64" | .2969 | 4-3/8" | 3-1/16" | 12 | \$7.33 |
| MRO-0564 | 5/64" | .0781 | 2" | 1" | 12 | \$1.97 | MRO-2064 | 5/16" | .3125 | 4-1/2" | 3-3/16" | 12 | \$7.44 |
| MRO-0664 | 3/32" | .0938 | 2-1/4" | 1-1/4" | 12 | \$2.09 | MRO-2164 | 21/64" | .3281 | 4-5/8" | 3-5/16" | 6 | \$8.33 |
| MRO-0764 | 7/64" | .1094 | 2-5/8" | 1-1/2" | 12 | \$2.15 | MRO-2264 | 11/32" | .3438 | 4-3/4" | 3-7/16" | 6 | \$9.40 |
| MRO-0864 | 1/8" | .1250 | 2-3/4" | 1-5/8" | 12 | \$2.27 | MRO-2364 | 23/64" | .3594 | 4-7/8" | 3-1/2" | 6 | \$10.58 |
| MRO-0964 | 9/64" | .1406 | 2-7/8" | 1-3/4" | 12 | \$2.45 | MRO-2464 | 3/8" | .3750 | 5" | 3-5/8" | 6 | \$10.65 |
| MRO-1064 | 5/32" | .1562 | 3-1/8" | 2" | 12 | \$2.69 | MRO-2564 | 25/64" | .3906 | 5-1/8" | 3-3/4" | 6 | \$12.97 |
| MRO-1164 | 11/64" | .1719 | 3-1/4" | 2-1/8" | 12 | \$2.93 | MRO-2664 | 13/32" | .4062 | 5-1/4" | 3-7/8" | 6 | \$13.27 |
| MRO-1264 | 3/16" | .1875 | 3-1/2" | 2-5/16" | 12 | \$3.53 | MRO-2764 | 27/64" | .4219 | 5-3/8" | 3-15/16" | 6 | \$14.69 |
| MRO-1364 | 13/64" | .2031 | 3-5/8" | 2-7/16" | 12 | \$4.04 | MRO-2864 | 7/16" | .4375 | 5-1/2" | 4-1/16" | 6 | \$15.71 |
| MRO-1464 | 7/32" | .2188 | 3-3/4" | 2-1/2" | 12 | \$4.08 | MRO-2964 | 29/64" | .4531 | 5-5/8" | 4-3/16" | 6 | \$18.33 |
| MRO-1564 | 15/64" | .2344 | 3-7/8" | 2-5/8" | 12 | \$4.42 | MRO-3064 | 15/32" | .4688 | 5-3/4" | 4-5/16" | 6 | \$18.51 |
| MRO-1664 | 1/4" | .2500 | 4" | 2-3/4" | 12 | \$4.85 | MRO-3164 | 31/64" | .4844 | 5-7/8" | 4-3/8" | 6 | \$19.31 |
| MRO-1764 | 17/64" | .2656 | 4-1/8" | 2-7/8" | 12 | \$5.83 | MRO-3264 | 1/2" | .5000 | 6" | 4-1/2" | 6 | \$19.56 |
| MRO-1864 | 9/32" | .2812 | 4-1/4" | 2-15/16" | 12 | \$6.78 | | | | | | | |

MRO Black & Gold Letter Drills - SUPER HEAVY DUTY

| Part # | Size | Dec. | OAL | Flute | Qty. | List | Part # | Size | Dec. | OAL | Flute | Qty. | List |
|--------|------|------|--------|----------|------|---------|--------|------|------|--------|---------|------|---------|
| MRO-A | A | .234 | 3-7/8" | 2-5/8" | 12 | \$6.06 | MRO-N | N | .302 | 4-3/8" | 3-1/16" | 6 | \$10.06 |
| MRO-B | B | .238 | 4" | 2-3/4" | 12 | \$6.06 | MRO-O | O | .316 | 4-1/2" | 3-3/16" | 6 | \$10.20 |
| MRO-C | C | .242 | 4" | 2-3/4" | 12 | \$5.84 | MRO-P | P | .323 | 4-5/8" | 3-5/16" | 6 | \$10.38 |
| MRO-D | D | .246 | 4" | 2-3/4" | 12 | \$5.84 | MRO-Q | Q | .332 | 4-3/4" | 3-7/16" | 6 | \$10.38 |
| MRO-E | E | .250 | 4" | 2-3/4" | 12 | \$5.85 | MRO-R | R | .339 | 4-3/4" | 3-7/16" | 6 | \$10.47 |
| MRO-F | F | .257 | 4-1/8" | 2-7/8" | 12 | \$6.42 | MRO-S | S | .348 | 4-7/8" | 3-1/2" | 6 | \$12.24 |
| MRO-G | G | .261 | 4-1/8" | 2-7/8" | 12 | \$6.69 | MRO-T | T | .358 | 4-7/8" | 3-1/2" | 6 | \$12.24 |
| MRO-H | H | .266 | 4-1/8" | 2-7/8" | 12 | \$7.00 | MRO-U | U | .368 | 5" | 3-5/8" | 6 | \$13.06 |
| MRO-I | I | .272 | 4-1/8" | 2-7/8" | 12 | \$7.04 | MRO-V | V | .377 | 5" | 3-5/8" | 6 | \$13.16 |
| MRO-J | J | .277 | 4-1/8" | 2-7/8" | 12 | \$8.25 | MRO-W | W | .386 | 5-1/8" | 3-3/4" | 6 | \$13.98 |
| MRO-K | K | .281 | 4-1/4" | 2-15/16" | 12 | \$8.25 | MRO-X | X | .397 | 5-1/8" | 3-3/4" | 6 | \$16.64 |
| MRO-L | L | .290 | 4-1/4" | 2-15/16" | 6 | \$9.48 | MRO-Y | Y | .404 | 5-1/4" | 3-7/8" | 6 | \$18.31 |
| MRO-M | M | .295 | 4-3/8" | 3-1/16" | 6 | \$10.06 | MRO-Z | Z | .413 | 5-1/4" | 3-7/8" | 6 | \$19.22 |



MRO Black & Gold Wire Gauge Drills - SUPER HEAVY DUTY

| Part # | Size | Dec. | OAL | Flute | Qty. | List | Part # | Size | Dec. | OAL | Flute | Qty. | List |
|--------|------|-------|--------|---------|------|--------|--------|------|-------|--------|---------|------|--------|
| MRO-01 | 1 | .2280 | 3-7/8" | 2-5/8" | 12 | \$5.44 | MRO-21 | 21 | .1590 | 3-1/4" | 2-1/8" | 12 | \$3.19 |
| MRO-02 | 2 | .2210 | 3-7/8" | 2-5/8" | 12 | \$5.14 | MRO-22 | 22 | .1570 | 3-1/8" | 2" | 12 | \$3.27 |
| MRO-03 | 3 | .2130 | 3-3/4" | 2-1/2" | 12 | \$5.11 | MRO-23 | 23 | .1540 | 3-1/8" | 2" | 12 | \$3.20 |
| MRO-04 | 4 | .2090 | 3-3/4" | 2-1/2" | 12 | \$5.11 | MRO-24 | 24 | .1520 | 3-1/8" | 2" | 12 | \$3.17 |
| MRO-05 | 5 | .2055 | 3-3/4" | 2-1/2" | 12 | \$5.14 | MRO-25 | 25 | .1495 | 3" | 1-7/8" | 12 | \$2.97 |
| MRO-06 | 6 | .2040 | 3-3/4" | 2-1/2" | 12 | \$5.14 | MRO-26 | 26 | .1470 | 3" | 1-7/8" | 12 | \$3.00 |
| MRO-07 | 7 | .2010 | 3-5/8" | 2-7/16" | 12 | \$4.41 | MRO-27 | 27 | .1440 | 3" | 1-7/8" | 12 | \$2.85 |
| MRO-08 | 8 | .1990 | 3-5/8" | 2-7/16" | 12 | \$4.50 | MRO-28 | 28 | .1405 | 2-7/8" | 1-3/4" | 12 | \$2.84 |
| MRO-09 | 9 | .1960 | 3-5/8" | 2-7/16" | 12 | \$4.50 | MRO-29 | 29 | .1360 | 2-7/8" | 1-3/4" | 12 | \$2.80 |
| MRO-10 | 10 | .1935 | 3-5/8" | 2-7/16" | 12 | \$4.37 | MRO-30 | 30 | .1285 | 2-3/4" | 1-5/8" | 12 | \$2.80 |
| MRO-11 | 11 | .1910 | 3-1/2" | 2-5/16" | 12 | \$4.29 | MRO-31 | 31 | .1200 | 2-3/4" | 1-5/8" | 12 | \$2.51 |
| MRO-12 | 12 | .1890 | 3-1/2" | 2-5/16" | 12 | \$4.30 | MRO-32 | 32 | .1160 | 2-3/4" | 1-5/8" | 12 | \$2.51 |
| MRO-13 | 13 | .1850 | 3-1/2" | 2-5/16" | 12 | \$4.06 | MRO-33 | 33 | .1130 | 2-5/8" | 1-1/2" | 12 | \$2.52 |
| MRO-14 | 14 | .1820 | 3-3/8" | 2-3/16" | 12 | \$4.08 | MRO-34 | 34 | .1110 | 2-5/8" | 1-1/2" | 12 | \$2.52 |
| MRO-15 | 15 | .1800 | 3-3/8" | 2-3/16" | 12 | \$4.06 | MRO-35 | 35 | .1100 | 2-5/8" | 1-1/2" | 12 | \$2.51 |
| MRO-16 | 16 | .1770 | 3-3/8" | 2-3/16" | 12 | \$3.98 | MRO-36 | 36 | .1065 | 2-1/2" | 1-7/16" | 12 | \$2.43 |
| MRO-17 | 17 | .1730 | 3-3/8" | 2-3/16" | 12 | \$3.77 | MRO-37 | 37 | .1040 | 2-1/2" | 1-7/16" | 12 | \$2.45 |
| MRO-18 | 18 | .1695 | 3-1/4" | 2-1/8" | 12 | \$3.48 | MRO-38 | 38 | .1015 | 2-1/2" | 1-7/16" | 12 | \$2.44 |
| MRO-19 | 19 | .1660 | 3-1/4" | 2-1/8" | 12 | \$3.48 | MRO-39 | 39 | .0995 | 2-3/8" | 1-3/8" | 12 | \$2.42 |
| MRO-20 | 20 | .1610 | 3-1/4" | 2-1/8" | 12 | \$3.46 | MRO-40 | 40 | .0980 | 2-3/8" | 1-3/8" | 12 | \$2.41 |

Made In



- ◆ 135° Split Point
- ◆ Ground Flute
- ◆ 3-Flat Shank on #1-12
- ◆ Heavy Duty Web for Strength & Rigidity
- ◆ Black & Gold Finish
- ◆ M2 HSS

**Sizes 41-60 are available upon request.

- Cast Iron
- Steel
- Steel Forging
- Stainless Steel



MRO

MADE IN USA



NOTE:
SIZES 40 → 60
HAVE NO
SPLIT POINT.



Made In



Black & Gold

- ◆ Jobber Length
- ◆ 135° Split Point
- ◆ Ground Flute
- ◆ Straight Shank
- ◆ Heavy Duty Web
- ◆ Black & Gold Finish
- ◆ M2 HSS

- ➔ Cast Iron
- ➔ Steel
- ➔ Steel Forging
- ➔ Stainless Steel



Parabolic Jobber Drills - SUPER HEAVY DUTY - M2 HSS

| Part # | Size | Dec. | OAL | Flute | Qty. | List | Part # | Size | Dec. | OAL | Flute | Qty. | List |
|---------|--------|-------|--------|----------|------|--------|---------|--------|-------|--------|----------|------|---------|
| PB-0464 | 1/16" | .0625 | 1-7/8" | 7/8" | 12 | \$2.28 | PB-1964 | 19/64" | .2969 | 4-3/8" | 3-1/16" | 12 | \$6.83 |
| PB-0564 | 5/64" | .0781 | 2" | 1" | 12 | \$2.28 | PB-2064 | 5/16" | .3125 | 4-1/2" | 3-3/16" | 12 | \$7.12 |
| PB-0664 | 3/32" | .0938 | 2-1/4" | 1-1/4" | 12 | \$2.28 | PB-2164 | 21/64" | .3281 | 4-5/8" | 3-5/16" | 6 | \$8.12 |
| PB-0764 | 7/64" | .1094 | 2-5/8" | 1-1/2" | 12 | \$2.51 | PB-2264 | 11/32" | .3438 | 4-3/4" | 3-7/16" | 6 | \$8.82 |
| PB-0864 | 1/8" | .1250 | 2-3/4" | 1-5/8" | 12 | \$2.51 | PB-2364 | 23/64" | .3594 | 4-7/8" | 3-1/2" | 6 | \$10.04 |
| PB-0964 | 9/64" | .1406 | 2-7/8" | 1-3/4" | 12 | \$2.63 | PB-2464 | 3/8" | .3750 | 5" | 3-5/8" | 6 | \$10.22 |
| PB-1064 | 5/32" | .1562 | 3-1/8" | 2" | 12 | \$2.63 | PB-2564 | 25/64" | .3906 | 5-1/8" | 3-3/4" | 6 | \$12.58 |
| PB-1164 | 11/64" | .1719 | 3-1/4" | 2-1/8" | 12 | \$2.80 | PB-2664 | 13/32" | .4062 | 5-1/4" | 3-7/8" | 6 | \$12.70 |
| PB-1264 | 3/16" | .1875 | 3-1/2" | 2-5/16" | 12 | \$3.10 | PB-2764 | 27/64" | .4219 | 5-3/8" | 3-15/16" | 6 | \$14.61 |
| PB-1364 | 13/64" | .2031 | 3-5/8" | 2-7/16" | 12 | \$3.39 | PB-2864 | 7/16" | .4375 | 5-1/2" | 4-1/16" | 6 | \$14.92 |
| PB-1464 | 7/32" | .2188 | 3-3/4" | 2-1/2" | 12 | \$4.03 | PB-2964 | 29/64" | .4531 | 5-5/8" | 4-3/16" | 6 | \$17.14 |
| PB-1564 | 15/64" | .2344 | 3-7/8" | 2-5/8" | 12 | \$4.38 | PB-3064 | 15/32" | .4688 | 5-3/4" | 4-5/16" | 6 | \$17.69 |
| PB-1664 | 1/4" | .2500 | 4" | 2-3/4" | 12 | \$4.50 | PB-3164 | 31/64" | .4844 | 5-7/8" | 4-3/8" | 6 | \$18.99 |
| PB-1764 | 17/64" | .2656 | 4-1/8" | 2-7/8" | 12 | \$5.61 | PB-3264 | 1/2" | .5000 | 6" | 4-1/2" | 6 | \$19.23 |
| PB-1864 | 9/32" | .2812 | 4-1/4" | 2-15/16" | 12 | \$6.37 | | | | | | | |

Extra Heavy Duty Web

30% thicker than even heavy duty webs, resists the extra shear stress found in deep hole drilling.

Parabolic Flute

Fast parabolic spiral allows deep hole drilling without frequent drill removal to clear chips.

Made In



- ◆ Jobber Length
- ◆ 135° Split Point
- ◆ Ground Flute
- ◆ Straight Shank
- ◆ Heavy Duty Web
- ◆ Gold Finish
- ◆ M42 Super Cobalt

- ➔ Hardened Steel
- ➔ Stainless Steel
- ➔ High Temp Alloys
- ➔ Heat Treated Materials
- ➔ Abrasive Plastics



Cobalt Jobber Drills - SUPER HEAVY DUTY - M42 SUPER COBALT

| Part # | Size | Dec. | OAL | Flute | Qty. | List | Part # | Size | Dec. | OAL | Flute | Qty. | List |
|---------|--------|-------|--------|----------|------|--------|---------|--------|-------|--------|----------|------|---------|
| CO-0464 | 1/16" | .0625 | 1-7/8" | 7/8" | 12 | \$3.01 | CO-1964 | 19/64" | .2969 | 4-3/8" | 3-1/16" | 12 | \$11.17 |
| CO-0564 | 5/64" | .0781 | 2" | 1" | 12 | \$3.01 | CO-2064 | 5/16" | .3125 | 4-1/2" | 3-3/16" | 12 | \$11.47 |
| CO-0664 | 3/32" | .0938 | 2-1/4" | 1-1/4" | 12 | \$3.01 | CO-2164 | 21/64" | .3281 | 4-5/8" | 3-5/16" | 6 | \$13.38 |
| CO-0764 | 7/64" | .1094 | 2-5/8" | 1-1/2" | 12 | \$3.12 | CO-2264 | 11/32" | .3438 | 4-3/4" | 3-7/16" | 6 | \$14.63 |
| CO-0864 | 1/8" | .1250 | 2-3/4" | 1-5/8" | 12 | \$3.53 | CO-2364 | 23/64" | .3594 | 4-7/8" | 3-1/2" | 6 | \$14.69 |
| CO-0964 | 9/64" | .1406 | 2-7/8" | 1-3/4" | 12 | \$3.97 | CO-2464 | 3/8" | .3750 | 5" | 3-5/8" | 6 | \$14.74 |
| CO-1064 | 5/32" | .1562 | 3-1/8" | 2" | 12 | \$4.08 | CO-2564 | 25/64" | .3906 | 5-1/8" | 3-3/4" | 6 | \$17.69 |
| CO-1164 | 11/64" | .1719 | 3-1/4" | 2-1/8" | 12 | \$4.25 | CO-2664 | 13/32" | .4062 | 5-1/4" | 3-7/8" | 6 | \$19.90 |
| CO-1264 | 3/16" | .1875 | 3-1/2" | 2-5/16" | 12 | \$4.91 | CO-2764 | 27/64" | .4219 | 5-3/8" | 3-15/16" | 6 | \$22.45 |
| CO-1364 | 13/64" | .2031 | 3-5/8" | 2-7/16" | 12 | \$6.18 | CO-2864 | 7/16" | .4375 | 5-1/2" | 4-1/16" | 6 | \$22.96 |
| CO-1464 | 7/32" | .2188 | 3-3/4" | 2-1/2" | 12 | \$6.35 | CO-2964 | 29/64" | .4531 | 5-5/8" | 4-3/16" | 6 | \$26.31 |
| CO-1564 | 15/64" | .2344 | 3-7/8" | 2-5/8" | 12 | \$7.20 | CO-3064 | 15/32" | .4688 | 5-3/4" | 4-5/16" | 6 | \$27.05 |
| CO-1664 | 1/4" | .2500 | 4" | 2-3/4" | 12 | \$7.17 | CO-3164 | 31/64" | .4844 | 5-7/8" | 4-3/8" | 6 | \$28.75 |
| CO-1764 | 17/64" | .2656 | 4-1/8" | 2-7/8" | 12 | \$8.51 | CO-3264 | 1/2" | .5000 | 6" | 4-1/2" | 6 | \$29.03 |
| CO-1864 | 9/32" | .2812 | 4-1/4" | 2-15/16" | 12 | \$9.13 | | | | | | | |

29 PC Jobber Sets - Bullet Case

| Part # | Set | Sizes | Type | Drills | Point | List |
|--------|-------|----------------------|-------------------|--------|-----------|----------|
| BG-1 | 29 pc | 1/16" → 1/2" x 64ths | BLACK & GOLD | p. 17 | 135° S.P. | \$142.28 |
| BX-1 | 29 pc | 1/16" → 1/2" x 64ths | BLACK OXIDE | p. 12 | 135° S.P. | \$124.52 |
| CX-1 | 29 pc | 1/16" → 1/2" x 64ths | COBALT | p. 20 | 135° S.P. | \$236.78 |
| TI-1 | 29 pc | 1/16" → 1/2" x 64ths | TITANIUM | p. 22 | 135° S.P. | \$215.89 |
| BT-1 | 29 pc | 1/16" → 1/2" x 64ths | BRIGHT | p. 10 | 118° | \$142.70 |
| MC-1 | 29 pc | 1/16" → 1/2" x 64ths | MECHANICS 3-FLAT* | p. 18 | 135° S.P. | \$181.60 |
| MRO-1F | 29 pc | 1/16" → 1/2" x 64ths | MRO 3-FLAT* | p. 24 | 135° S.P. | \$231.99 |
| PB-1 | 29 pc | 1/16" → 1/2" x 64ths | PARABOLIC* | p. 26 | 135° S.P. | \$237.03 |
| CO-1 | 29 pc | 1/16" → 1/2" x 64ths | COBALT* | p. 26 | 135° S.P. | \$344.92 |

◆ Huot Bullet Case

* Made in USA

S.P. = Split Point



Mechanics
Black & Gold
MC-1



Black & Gold
BG-1



Black Oxide
BX-1



Cobalt
CX-1



Titanium
TI-1



Bright
BT-1



13 PC Jobber Sets - Straight Shank

| Part # | Set | Sizes | Type | Drills | Point | List |
|---------|-------|----------------------|---------------|--------|-----------|---------|
| AD-13 | 13 pc | 1/16" → 1/4" x 64ths | Black Oxide | p.11 | 118° | \$15.91 |
| BT-13 | 13 pc | 1/16" → 1/4" x 64ths | Bright Finish | p.10 | 118° | \$24.17 |
| SP-13 | 13 pc | 1/16" → 1/4" x 64ths | Black Oxide | p.12 | 135° S.P. | \$23.06 |
| BG-13 | 13 pc | 1/16" → 1/4" x 64ths | Black & Gold | p.17 | 135° S.P. | \$29.90 |
| CX-13 | 13 pc | 1/16" → 1/4" x 64ths | Cobalt | p.20 | 135° S.P. | \$40.83 |
| CO-13 | 13 pc | 1/16" → 1/4" x 64ths | Cobalt* | p.26 | 135° S.P. | \$51.84 |
| TI-13 | 13 pc | 1/16" → 1/4" x 64ths | Titanium | p.22 | 135° S.P. | \$46.78 |
| MRO-13F | 13 pc | 1/16" → 1/4" x 64ths | MRO 3-FLAT* | p.24 | 135° S.P. | \$49.68 |
| PB-13 | 13 pc | 1/16" → 1/4" x 64ths | Parabolic* | p.26 | 135° S.P. | \$39.78 |

◆ Metal Huot Case

* Made in USA

S.P. = Split Point



15 PC Jobber Sets - Straight Shank

| Part # | Set | Sizes | Type | Drills | Point | List |
|---------|-------|----------------------|--------------|--------|-----------|----------|
| SP-15 | 15 pc | 1/16" → 1/2" x 32nds | Black Oxide | p.12 | 135° S.P. | \$74.02 |
| BG-15 | 15 pc | 1/16" → 1/2" x 32nds | Black & Gold | p.17 | 135° S.P. | \$82.45 |
| CX-15 | 15 pc | 1/16" → 1/2" x 32nds | Cobalt | p.20 | 135° S.P. | \$131.79 |
| CO-15 | 15 pc | 1/16" → 1/2" x 32nds | Cobalt* | p.26 | 135° S.P. | \$151.93 |
| MRO-15F | 15 pc | 1/16" → 1/2" x 32nds | MRO 3-FLAT* | p.24 | 135° S.P. | \$133.15 |
| PB-15 | 15 pc | 1/16" → 1/2" x 32nds | Parabolic* | p.26 | 135° S.P. | \$102.46 |

◆ Metal Huot Case

* Made in USA

S.P. = Split Point



29 PC Jobber Sets - Straight Shank

| Part # | Set | Sizes | Type | Drills | Point | List |
|---------|-------|----------------------|---------------|--------|-----------|----------|
| AD-29 | 29 pc | 1/16" → 1/2" x 64ths | Black Oxide | p.11 | 118° | \$77.87 |
| BT-29 | 29 pc | 1/16" → 1/2" x 64ths | Bright Finish | p.10 | 118° | \$137.17 |
| SP-29 | 29 pc | 1/16" → 1/2" x 64ths | Black Oxide | p.12 | 135° S.P. | \$124.52 |
| BG-29 | 29 pc | 1/16" → 1/2" x 64ths | Black & Gold | p.17 | 135° S.P. | \$162.88 |
| CX-29 | 29 pc | 1/16" → 1/2" x 64ths | Cobalt | p.20 | 135° S.P. | \$246.05 |
| CO-29 | 29 pc | 1/16" → 1/2" x 64ths | Cobalt* | p.26 | 135° S.P. | \$286.18 |
| TI-29 | 29 pc | 1/16" → 1/2" x 64ths | Titanium | p.22 | 135° S.P. | \$267.39 |
| MRO-29F | 29 pc | 1/16" → 1/2" x 64ths | MRO 3-FLAT* | p.24 | 135° S.P. | \$234.42 |
| PB-29 | 29 pc | 1/16" → 1/2" x 64ths | Parabolic* | p.26 | 135° S.P. | \$179.10 |

◆ Metal Huot Case

* Made in USA

S.P. = Split Point

29 PC Jobber Sets - 3/8" Shank

| Part # | Set | Sizes | Type | Drills | Point | List |
|--------|-------|----------------------|--------------|--------|-----------|----------|
| SP-29R | 29 pc | 1/16" → 1/2" x 64ths | Black Oxide | p.13 | 135° S.P. | \$162.55 |
| BG-29R | 29 pc | 1/16" → 1/2" x 64ths | Black & Gold | p.18 | 135° S.P. | \$183.59 |
| CX-29R | 29 pc | 1/16" → 1/2" x 64ths | Cobalt | p.21 | 135° S.P. | \$277.71 |

1/16" - 3/8" STRAIGHT SHANK, 25/64" - 1/2" WITH 3/8" SHANK

S.P. = Split Point

◆ Metal Huot Case



8 PC Silver & Deming Sets

| Part # | Set | Sizes | Type | Drills | Point | List |
|--------|------|-----------|--------------|--------|-----------|----------|
| AD-8 | 8 pc | See Below | Black Oxide | p.15 | 118° | \$190.77 |
| BG-8 | 8 pc | See Below | Black & Gold | p.19 | 118° | \$258.94 |
| CX-8 | 8 pc | See Below | Cobalt | p.21 | 135° S.P. | \$530.51 |

ALL SETS: 9/16", 5/8", 11/16", 3/4", 13/16", 7/8", 15/16", 1"

S.P. = Split Point

◆ Metal Huot Case



60 PC Wire Gauge Sets

| Part # | Set | Sizes | Type | Drills | Point | List |
|--------|-------|----------|--------------|--------|-----------|----------|
| SP-60 | 60 pc | #1 → #60 | Black Oxide | p.12 | 135° S.P. | \$90.27 |
| BG-60 | 60 pc | #1 → #60 | Black & Gold | p.17 | 135° S.P. | \$96.17 |
| CX-60 | 60 pc | #1 → #60 | Cobalt | p.20 | 135° S.P. | \$194.95 |

S.P. = Split Point

◆ Metal Huot Case





LETTER A → Z Sets - Straight Shank

| Part # | Set | Sizes | Type | Drills | Point | List |
|--------|-------|-------|--------------|--------|-----------|----------|
| SP-AZ | 26 pc | A → Z | Black Oxide | p.13 | 135° S.P. | \$151.37 |
| BG-AZ | 26 pc | A → Z | Black & Gold | p.19 | 135° S.P. | \$161.74 |

◆ Metal Huot Case

S.P. = Split Point



115 PC MASTER Sets - Straight Shank

| Part # | Set | Sizes | Type | Drills | Point | List |
|--------|--------|-----------|--------------|--------|-----------|----------|
| SP-115 | 115 pc | See Below | Black Oxide | p.12 | 135° S.P. | \$376.98 |
| BG-115 | 115 pc | See Below | Black & Gold | p.17 | 135° S.P. | \$431.61 |
| CX-115 | 115 pc | See Below | Cobalt | p.20 | 135° S.P. | \$731.75 |

JOBBER SIZES: 1/16" → 1/2", WIRE GAUGE DRILL SIZES #1 → #60,
LETTER SIZES: A → Z. STRAIGHT SHANK.

◆ Metal Huot Case

S.P. = Split Point



METRIC Sets - Straight Shank

| Part # | Set | Sizes | Type | Drills | Point | List |
|--------|-------|------------------|-------------|--------|-------|----------|
| MM-11 | 11 pc | 1.00MM → 6.00MM | Black Oxide | p.13 | 118° | \$24.57 |
| MM-25 | 25 pc | 1.00MM → 13.00MM | Black Oxide | p.13 | 118° | \$122.15 |

◆ Metal Huot Case



TAP & DRILL Sets - CARBON / HSS TAPS

| Part # | Sizes | Type | Drills | Point | List |
|-----------|-----------|-------------|--------|-----------|---------|
| CD-SP-019 | See Below | Carbon Taps | p.11 | 118° | \$58.41 |
| TD-SP-019 | See Below | HSS Taps | p.12 | 135° S.P. | \$81.93 |

HSS DRILL BIT SIZES: #36, #29, #25, #21, #7, F, 5/16", U, 27/64"
TAP SIZES: 6-32, 8-32, 10-24, 10-32, 1/4"-20, 5/16"-18, 3/8"-16, 7/16"-14, 1/2"-13

◆ Metal Huot Case

525 Pc. Dispenser Contains:

| | | | | |
|-----------|------------|------------|-----------|------------|
| 24- 1/16" | 24- 5/64" | 48- 3/32" | 24- 7/64" | 72- 1/8" |
| 24- 9/64" | 36- 5/32" | 24- 11/64" | 48- 3/16" | 24- 13/64" |
| 24- 7/32" | 12- 15/64" | 60- 1/4" | 3- 17/64" | 12- 9/32" |
| 3- 19/64" | 12- 5/16" | 3- 21/64" | 3- 11/32" | 3- 23/64" |
| 12- 3/8" | 3- 25/64" | 3- 13/32" | 3- 27/64" | 6- 7/16" |
| 3- 29/64" | 3- 15/32" | 3- 31/64" | 6- 1/2" | |

This attractive drill bit merchandiser puts all 29 essential jobber sizes at your fingertips. Made of heavy duty steel construction, this deep red cabinet dispenser fits perfectly on any counter top. Comes with lock and key.



525 PC Jobber Countertop Dispenser

| Part # | Set | Sizes | Type | Drills | Point | List |
|---------|--------|----------------------|--------------|--------|-----------|-----------|
| SP-525 | 525 pc | 1/16" → 1/2" x 64ths | Black Oxide | p.12 | 135° S.P. | \$1040.86 |
| BG-525 | 525 pc | 1/16" → 1/2" x 64ths | Black & Gold | p.17 | 135° S.P. | \$1498.34 |
| MC-525 | 525 pc | 1/16" → 1/2" x 64ths | Mechanics* | p.18 | 135° S.P. | \$2324.97 |
| CX-525 | 525 pc | 1/16" → 1/2" x 64ths | Cobalt | p.20 | 135° S.P. | \$1950.98 |
| MRO-525 | 525 pc | 1/16" → 1/2" x 64ths | MRO 3-FLAT* | p.24 | 135° S.P. | \$2431.83 |

S.P. = Split Point

* Made in USA

◆ Metal Huot Case

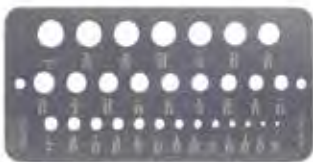

Metal Drill Gauges

| Part # | Description | Sizes | List |
|---------|---------------|---------------|---------|
| 29GAUGE | 29 Hole Gauge | 1/16" → 1/2" | \$12.05 |
| 60GAUGE | 60 Hole Gauge | #1 → #60 Wire | \$14.34 |



Single (1) Flute Counter Sinks - HSS

- ◆ HSS
- ◆ Milled Body
- ◆ Ground Flute
- Iron
- Steel
- Plastic
- Light to Medium Metals

| 60° Part # | 82° Part # | 90° Part # | 100° Part # | Size | Shank Diameter | Shank Length | OAL | List |
|------------|------------|------------|-------------|-------|----------------|--------------|--------|---------|
| CI-60-1264 | CI-82-1264 | CI-90-1264 | CI-100-1264 | 3/16" | 3/16" | 3/4" | 1-1/2" | \$10.00 |
| CI-60-1664 | CI-82-1664 | CI-90-1664 | CI-100-1664 | 1/4" | 1/4" | 3/4" | 2" | \$10.21 |
| CI-60-2064 | CI-82-2064 | CI-90-2064 | CI-100-2064 | 5/16" | 1/4" | 1" | 2" | \$11.94 |
| CI-60-2464 | CI-82-2464 | CI-90-2464 | CI-100-2464 | 3/8" | 1/4" | 1" | 2" | \$14.17 |
| CI-60-3264 | CI-82-3264 | CI-90-3264 | CI-100-3264 | 1/2" | 1/4" | 1" | 2" | \$17.64 |
| CI-60-4064 | CI-82-4064 | CI-90-4064 | CI-100-4064 | 5/8" | 3/8" | 1-1/8" | 2-3/4" | \$27.08 |
| CI-60-4864 | CI-82-4864 | CI-90-4864 | CI-100-4864 | 3/4" | 3/8" | 1-5/16" | 2-3/4" | \$30.35 |
| CI-60-5064 | CI-82-5064 | CI-90-5064 | CI-100-5064 | 7/8" | 1/2" | 1-5/16" | 2-3/4" | \$48.26 |
| CI-60-6464 | CI-82-6464 | CI-90-6464 | CI-100-6464 | 1" | 1/2" | 1-5/16" | 2-3/4" | \$53.61 |



Three (3) Flute Counter Sinks - HSS

| 60° Part # | 82° Part # | 90° Part # | 100° Part # | Size | Shank Diameter | Shank Length | OAL | List |
|------------|------------|------------|-------------|------|----------------|--------------|--------|---------|
| R3-60-1664 | R3-82-1664 | R3-90-1664 | R3-100-1664 | 1/4" | 3/16" | 3/4" | 1-1/2" | \$10.21 |
| R3-60-2464 | R3-82-2464 | R3-90-2464 | R3-100-2464 | 3/8" | 1/4" | 7/8" | 2-3/4" | \$14.17 |
| R3-60-3264 | R3-82-3264 | R3-90-3264 | R3-100-3264 | 1/2" | 3/8" | 1" | 2" | \$17.64 |
| R3-60-4064 | R3-82-4064 | R3-90-4064 | R3-100-4064 | 5/8" | 3/8" | 1" | 2-1/4" | \$27.08 |
| R3-60-4864 | R3-82-4864 | R3-90-4864 | R3-100-4864 | 3/4" | 1/2" | 1-1/4" | 2-5/8" | \$30.35 |
| R3-60-6464 | R3-82-6464 | R3-90-6464 | R3-100-6464 | 1" | 1/2" | 1-1/4" | 2-3/4" | \$53.61 |



CARDED



Part # SE-006-16
6 Pc. Screw Extractor Set
 #1, #2, #3, #4, #5, #6
Price Each \$23.10



Screw Extractor - LEFT HAND SPIRAL FLUTE

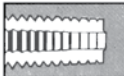

| Part # | Size | Shank Diameter | Removes Screws or | Pipe | List |
|--------|------|----------------|-------------------|-----------|---------|
| SE0001 | 1 | 5/64" | 3/32" to 5/32" | | \$1.92 |
| SE0002 | 2 | 7/64" | 5/32" to 7/32" | | \$2.28 |
| SE0003 | 3 | 5/32" | 7/32" to 9/32" | | \$2.80 |
| SE0004 | 4 | 1/4" | 9/32" to 3/8" | 1/8" Pipe | \$3.50 |
| SE0005 | 5 | 19/64" | 3/8" to 5/8" | 1/4" Pipe | \$4.62 |
| SE0006 | 6 | 13/32" | 5/8" to 7/8" | 3/8" Pipe | \$8.22 |
| SE0007 | 7 | 17/32" | 7/8" to 1-1/8" | 1/2" Pipe | \$12.83 |
| SE0008 | 8 | 13/16" | 1-1/8" to 1-3/8" | 3/4" Pipe | \$23.93 |
| SE0009 | 9 | 1-1/16" | 1-3/8" to 2" | 1" Pipe | \$34.85 |

TAPER



8 to 10 threads chamfered for easy thread starting in tough material.

PLUG

3 to 5 threads chamfered for general use when tapping to bottom of hole is not critical. **This is the most popular tap of all three styles.**

BOTTOM

1-1/2 threads chamfered for use after threads have been started. Used for clean tapping to bottom of holes.

NC = National Course
NF = National Fine



Packaging:
Sizes
0-80 → 1/2"-20
5 / box

Sold Individually
over 1/2"-20.

| DRILL THIS SIZE HOLE | | | TO TAP FOR THIS BOLT OR SCREW |
|----------------------|------------|------------------|-------------------------------|
| DECIMAL INCHES | DRILL SIZE | NEAREST FRACTION | |
| .0469" | 3/64" | 3/64" | 0-80 NF |
| .0595" | No. 53 | none | 1-64 NC |
| .0595" | No. 53 | 1/16" | 1-72 NF |
| .0700" | No. 50 | none | 2-56 NC |
| .0700" | No. 50 | none | 2-64 NF |
| .0785" | No. 47 | 5/64" | 3-48 NC |
| .0820" | No. 45 | none | 3-56 NF |
| .0860" | No. 44 | none | 4-36 NS |
| .0890" | No. 43 | 3/32" | 4-40 NC |
| .0935" | No. 42 | 3/32" | 4-48 NF |
| .0984" | 2.5mm | none | 3mm-0.60mm |
| .1015" | No. 38 | none | 1/8-40 NS |
| .1015" | No. 38 | none | 5-40 NC |
| .1040" | No. 37 | none | 5-44 NF |
| .1100" | No. 35 | 7/64" | 6-32 NC |
| .1110" | No. 34 | none | 6-36 NS |
| .1130" | No. 33 | none | 6-40 NF |
| .1200" | No. 31 | none | 6-48 NS |
| .1338" | 3.4mm | none | 4mm-0.70mm |
| .1338" | 3.4mm | none | 4mm-0.75mm |
| .1360" | No. 29 | none | 8-32 NC |
| .1360" | No. 29 | 9/64" | 8-36 NF |
| .1405" | No. 28 | none | 8-40 NS |
| .1470" | No. 26 | none | 3/16-24 NS |
| .1495" | No. 25 | 5/32" | 10-24 NC |
| .1570" | No. 22 | none | 3/16-32 NS |
| .1590" | No. 21 | 5/32" | 10-32 NF |
| .1653" | 4.2mm | none | 5mm-0.90mm |
| .1693" | 4.3mm | none | 5mm-0.80mm |
| .1770" | No. 16 | 11/64" | 12-24 NC |
| .1820" | No. 14 | 3/16" | 12-28 NF |
| .1850" | No. 13 | none | 12-32 NEF |
| .1935" | No. 10 | none | 14-20 NS |
| .2010" | No. 7 | 13/64" | 1/4-20 NC |
| .2010" | No. 7 | none | 14-24 NS |
| .2047" | 5.2mm | none | 6mm-1.00mm |
| .2090" | No. 4 | none | 1/4-24 NS |
| .2130" | No. 3 | 7/32" | 1/4-28 NF |
| .2188" | 7/32" | 7/32" | 1/4-32 NEF |
| .2280" | No. 1 | none | 1/4-40 NS |
| .2401" | 6.1mm | 15/64" | 7mm-1.00mm |
| .2570" | Ltr. F | 17/64" | 5/16-18 NC |
| .2716" | 6.9mm | 17/64" | 8mm-1.25mm |
| .2720" | Ltr. I | none | 5/16-24 NF |
| .2795" | 7.1mm | none | 8mm-1.00mm |
| .2812" | 9/32" | 9/32" | 5/16-32 NEF |
| .3110" | 7.9mm | none | 9mm-1.25mm |
| .3125" | 5/16" | 5/16" | 3/8-16 NC |

| DRILL THIS SIZE HOLE | | | TO TAP FOR THIS BOLT OR SCREW |
|----------------------|------------|------------------|-------------------------------|
| DECIMAL INCHES | DRILL SIZE | NEAREST FRACTION | |
| .3189" | 8.1mm | none | 9mm-1.00mm |
| .3268" | 8.3mm | none | 9mm-0.75mm |
| .3320" | Ltr. Q | 21/64" | 3/8-24 NF |
| .3425" | 8.7mm | none | 10mm-1.50mm |
| .3503" | 8.9mm | 11/32" | 10mm-1.25mm |
| .3583" | 9.1mm | none | *10mm-1.00mm |
| .3680" | Ltr. U | 23/64" | 7/16"-14 NC |
| .3818" | 9.7mm | none | 11mm-1.50mm |
| .3906" | 25/64" | 25/64" | 7/16-20 NF |
| .4133" | 10.5mm | none | 12mm-1.75mm |
| .4212" | 10.7mm | 27/64" | 12mm-1.50mm |
| .4219" | 27/64" | 27/64" | 1/2-13 NC |
| .4291" | 10.9mm | 27/64" | *12mm-1.25mm |
| .4531" | 29/64" | 29/64" | 1/2-20 NF |
| .4531" | 29/64" | 29/64" | 1/2-24 NS |
| .4803" | 12.2mm | none | 14mm-2.00mm |
| .4844" | 31/64" | 31/64" | 9/16-12 NC |
| .4999" | 12.7mm | none | 14mm-1.50mm |
| .5039" | 12.8mm | none | *14mm-1.25mm |
| .5156" | 33/64" | 33/64" | 9/16-18 NF |
| .5312" | 17/32" | 17/32" | 5/8-11 NC |
| .5590" | 14.2mm | 35/64" | 16mm-2.00mm |
| .5781" | 37/64" | 37/64" | 5/8-18 NF |
| .5787" | 14.7mm | none | 16mm-1.50mm |
| .5938" | 19/32" | 19/32" | 11/16-11 NS |
| .6220" | 15.8mm | 39/64" | 18mm-2.50mm |
| .6250" | 5/8" | 5/8" | 11/16-16 NS |
| .6562" | 21/32" | 21/32" | 3/4-10 NC |
| .6614" | 16.8mm | none | *18mm-1.50mm |
| .6875" | 11/16" | 11/16" | 3/4-16 NF |
| .7008" | 17.8mm | 11/16" | 20mm-2.50mm |
| .7656" | 49/64" | 49/64" | 7/8-9 NC |
| .8125" | 13/16" | 13/16" | 7/8-14 NF |
| .8228" | 20.9mm | none | 22mm-1.50mm |
| .8281" | 53/64" | 53/64" | *7/8-18 NS |
| .8425" | 21.4mm | 53/64" | 24mm-3.00mm |
| .8750" | 7/8" | 7/8" | 1-8 NC |
| .8779" | 22.3mm | none | 24mm-2.00mm |
| .9219" | 59/64" | 59/64" | 1-12 NF |
| .9375" | 15/16" | 15/16" | 1-14 NS |
| .9844" | 63/64" | 63/64" | 1-1/8 - 7 NC |
| 1.0469" | 1-3/64" | 1-3/64" | 1-1/8 - 12 NF |
| 1.1094" | 1-7/64" | 1-7/64" | 1-1/4 - 7 NC |
| 1.1719" | 1-11/64" | 1-11/64" | 1-1/4 - 12 NF |
| 1.2188" | 1-7/32" | 1-7/32" | 1-3/8 - 6 NC |
| 1.2969" | 1-19/64" | 1-19/64" | 1-3/8 - 12 NF |
| 1.3468" | 1-11/32" | 1-11/32" | 1-1/2 - 6 NC |
| 1.4219" | 1-27/64" | 1-27/64" | 1-1/2 - 12 NF |

* Spark Plug Taps.



NPT Tap-Drill Chart
Available on Page 36.



Carbon Steel Hand Taps - MACHINE SCREW

| PART # | | | Machine Screw Thread | No. Of Flutes | Ground Thread Limit | OAL | Use Thread Length | Drill Size | List |
|-----------|-----------|-----------|----------------------------|---------------------|---------------------------|----------|-------------------------|---------------|--------|
| TAPER | PLUG | BOTTOM | | | | | | | |
| C62NC0004 | C63NC0004 | C64NC0004 | 4-40 NC | 3 | H2 | 1-7/8" | 9/16" | 43 | \$2.48 |
| C62NF0004 | C63NF0004 | C64NF0004 | 4-48 NF | 3 | H2 | 1-7/8" | 9/16" | 42 | \$2.48 |
| C62NC0005 | C63NC0005 | C64NC0005 | 5-40 NC | 3 | H2 | 1-15/16" | 7/8" | 38 | \$2.48 |
| C62NF0005 | C63NF0005 | C64NF0005 | 5-44 NF | 3 | H2 | 1-15/16" | 7/8" | 37 | \$2.48 |
| C62NC0006 | C63NC0006 | C64NC0006 | 6-32 NC | 3 | H2 | 2" | 11/16" | 35 | \$2.48 |
| C62NF0006 | C63NF0006 | C64NF0006 | 6-40 NF | 3 | H2 | 2" | 11/16" | 33 | \$2.48 |
| C62NC0008 | C63NC0008 | C64NC0008 | 8-32 NC | 4 | H3 | 2-1/8" | 3/4" | 29 | \$2.60 |
| C62NF0008 | C63NF0008 | C64NF0008 | 8-36 NF | 4 | H3 | 2-1/8" | 3/4" | 29 | \$2.60 |
| C62NC0010 | C63NC0010 | C64NC0010 | 10-24 NC | 4 | H3 | 2-3/8" | 7/8" | 25 | \$2.77 |
| C62NF0010 | C63NF0010 | C64NF0010 | 10-32 NF | 4 | H3 | 2-3/8" | 7/8" | 21 | \$2.77 |
| C62NC0012 | C63NC0012 | C64NC0012 | 12-24 NC | 4 | H3 | 2-3/8" | 15/16" | 16 | \$3.79 |
| C62NF0012 | C63NF0012 | C64NF0012 | 12-28 NF | 4 | H3 | 2-3/8" | 15/16" | 14 | \$3.79 |



5 PCS. PER
PACK FROM
4-40 TO
1/2"-20.
SOLD
1 PC.
OVER 1/2"-20.

Carbon Steel Hand Taps - FRACTIONAL

| PART # | | | Machine Screw Thread | No. Of Flutes | Ground Thread Limit | OAL | Use Thread Length | Drill Size | List |
|-----------|-----------|-----------|----------------------------|---------------------|---------------------------|----------|-------------------------|---------------|---------|
| TAPER | PLUG | BOTTOM | | | | | | | |
| C65NC0310 | C66NC0310 | C67NC0310 | 1/4"-20 NC | 4 | H3 | 2-1/2" | 1" | 7 | \$2.50 |
| C65NF0312 | C66NF0312 | C67NF0312 | 1/4"-28 NF | 4 | H3 | 2-1/2" | 1" | 3 | \$2.50 |
| C65NC0315 | C66NC0315 | C67NC0315 | 5/16"-18 NC | 4 | H3 | 2-23/32" | 1-1/8" | F | \$3.47 |
| C65NF0316 | C66NF0316 | C67NF0316 | 5/16"-24 NF | 4 | H3 | 2-23/32" | 1-1/8" | I | \$3.47 |
| C65NC0318 | C66NC0318 | C67NC0318 | 3/8"-16 NC | 4 | H3 | 2-15/16" | 1-1/4" | 5/16" | \$3.97 |
| C65NF0319 | C66NF0319 | C67NF0319 | 3/8"-24 NF | 4 | H3 | 2-15/16" | 1-1/4" | Q | \$3.97 |
| C65NC0320 | C66NC0320 | C67NC0320 | 7/16"-14 NC | 4 | H3 | 3-5/32" | 1-7/16" | U | \$4.77 |
| C65NF0321 | C66NF0321 | C67NF0321 | 7/16"-20 NF | 4 | H3 | 3-5/32" | 1-7/16" | 25/64" | \$4.77 |
| C65NC0322 | C66NC0322 | C67NC0322 | 1/2"-13 NC | 4 | H3 | 3-3/8" | 1-21/32" | 27/64" | \$6.37 |
| C65NF0323 | C66NF0323 | C67NF0323 | 1/2"-20 NF | 4 | H3 | 3-3/8" | 1-21/32" | 29/64" | \$6.37 |
| C65NC0325 | C66NC0325 | C67NC0325 | 9/16"-12 NC | 4 | H3 | 3-19/32" | 1-21/32" | 31/64" | \$8.28 |
| C65NF0326 | C66NF0326 | C67NF0326 | 9/16"-18 NF | 4 | H3 | 3-19/32" | 1-21/32" | 33/64" | \$8.28 |
| C65NC0327 | C66NC0327 | C67NC0327 | 5/8"-11 NC | 4 | H3 | 3-13/16" | 1-13/16" | 17/32" | \$10.16 |
| C65NF0328 | C66NF0328 | C67NF0328 | 5/8"-18 NF | 4 | H3 | 3-13/16" | 1-13/16" | 37/64" | \$10.16 |
| C65NC0331 | C66NC0331 | C67NC0331 | 3/4"-10 NC | 4 | H3 | 4-1/4" | 2" | 21/32" | \$11.75 |
| C65NF0332 | C66NF0332 | C67NF0332 | 3/4"-16 NF | 4 | H3 | 4-1/4" | 2" | 11/16" | \$11.75 |
| C65NC0333 | C66NC0333 | C67NC0333 | 7/8"-9 NC | 4 | H4 | 4-11/16" | 2-7/32" | 49/64" | \$17.93 |
| C65NF0334 | C66NF0334 | C67NF0334 | 7/8"-14 NF | 4 | H4 | 4-11/16" | 2-7/32" | 13/16" | \$17.93 |
| C65NC0335 | C66NC0335 | C67NC0335 | 1"-8 NC | 4 | H4 | 5-1/8" | 2-1/2" | 7/8" | \$22.64 |
| C65NF0336 | C66NF0336 | C67NF0336 | 1"-12 NF | 4 | H4 | 5-1/8" | 2-1/2" | 59/64" | \$22.64 |
| C65NS0337 | C66NS0337 | C67NS0337 | 1"-14 NS | 4 | H4 | 5-1/8" | 2-1/2" | 15/16" | \$22.64 |
| C65NC0338 | C66NC0338 | C67NC0338 | 1-1/8"- 7 NC | 4 | H4 | 5-7/16" | 2-9/16" | 63/64" | \$40.15 |

(HSS) High Speed Steel Hand Taps - MACHINE SCREW GROUND THREAD

| PART # | | | Machine Screw Thread | No. Of Flutes | Ground Thread Limit | OAL | Use Thread Length | Drill Size | List |
|-----------|-----------|-----------|----------------------|---------------|---------------------|----------|-------------------|------------|--------|
| TAPER | PLUG | BOTTOM | | | | | | | |
| 262NC0004 | 263NC0004 | 264NC0004 | 4-40 NC | 3 | H2 | 1-7/8" | 9/16" | 43 | \$5.50 |
| 262NF0004 | 263NF0004 | 264NF0004 | 4-48 NF | 3 | H2 | 1-7/8" | 9/16" | 42 | \$5.50 |
| 262NC0005 | 263NC0005 | 264NC0005 | 5-40 NC | 3 | H2 | 1-15/16" | 7/8" | 38 | \$5.50 |
| 262NF0005 | 263NF0005 | 264NF0005 | 5-44 NF | 3 | H2 | 1-15/16" | 7/8" | 37 | \$5.50 |
| 262NC0006 | 263NC0006 | 264NC0006 | 6-32 NC | 3 | H2 | 2" | 11/16" | 35 | \$5.50 |
| 262NF0006 | 263NF0006 | 264NF0006 | 6-40 NF | 3 | H2 | 2" | 11/16" | 33 | \$5.50 |
| 262NC0008 | 263NC0008 | 264NC0008 | 8-32 NC | 4 | H3 | 2-1/8" | 3/4" | 29 | \$4.66 |
| 262NF0008 | 263NF0008 | 264NF0008 | 8-36 NF | 4 | H3 | 2-1/8" | 3/4" | 29 | \$4.66 |
| 262NC0010 | 263NC0010 | 264NC0010 | 10-24 NC | 4 | H3 | 2-3/8" | 7/8" | 25 | \$5.10 |
| 262NF0010 | 263NF0010 | 264NF0010 | 10-32 NF | 4 | H3 | 2-3/8" | 7/8" | 21 | \$5.10 |
| 262NC0012 | 263NC0012 | 264NC0012 | 12-24 NC | 4 | H3 | 2-3/8" | 15/16" | 16 | \$5.42 |
| 262NF0012 | 263NF0012 | 264NF0012 | 12-28 NF | 4 | H3 | 2-3/8" | 15/16" | 14 | \$5.42 |



(HSS) High Speed Steel Hand Taps - FRACTIONAL GROUND THREAD

| PART # | | | Machine Screw Thread | No. Of Flutes | Ground Thread Limit | OAL | Use Thread Length | Drill Size | List |
|-----------|-----------|-----------|----------------------|---------------|---------------------|----------|-------------------|------------|---------|
| TAPER | PLUG | BOTTOM | | | | | | | |
| 265NC0310 | 266NC0310 | 267NC0310 | 1/4"-20 NC | 4 | H3 | 2-1/2" | 1" | 7 | \$5.68 |
| 265NF0312 | 266NF0312 | 267NF0312 | 1/4"-28 NF | 4 | H3 | 2-1/2" | 1" | 3 | \$5.68 |
| 265NC0315 | 266NC0315 | 267NC0315 | 5/16"-18 NC | 4 | H3 | 2-23/32" | 1-1/8" | F | \$6.70 |
| 265NF0316 | 266NF0316 | 267NF0316 | 5/16"-24 NF | 4 | H3 | 2-23/32" | 1-1/8" | I | \$6.70 |
| 265NC0318 | 266NC0318 | 267NC0318 | 3/8"-16 NC | 4 | H3 | 2-15/16" | 1-1/4" | 5/16" | \$7.85 |
| 265NF0319 | 266NF0319 | 267NF0319 | 3/8"-24 NF | 4 | H3 | 2-15/16" | 1-1/4" | Q | \$7.85 |
| 265NC0320 | 266NC0320 | 267NC0320 | 7/16"-14 NC | 4 | H3 | 3-5/32" | 1-7/16" | U | \$12.15 |
| 265NF0321 | 266NF0321 | 267NF0321 | 7/16"-20 NF | 4 | H3 | 3-5/32" | 1-7/16" | 25/64" | \$12.15 |
| 265NC0322 | 266NC0322 | 267NC0322 | 1/2"-13 NC | 4 | H3 | 3-3/8" | 1-21/32" | 27/64" | \$14.43 |
| 265NF0323 | 266NF0323 | 267NF0323 | 1/2"-20 NF | 4 | H3 | 3-3/8" | 1-21/32" | 29/64" | \$14.43 |
| 265NC0325 | 266NC0325 | 267NC0325 | 9/16"-12 NC | 4 | H3 | 3-19/32" | 1-21/32" | 31/64" | \$17.05 |
| 265NF0326 | 266NF0326 | 267NF0326 | 9/16"-18 NF | 4 | H3 | 3-19/32" | 1-21/32" | 33/64" | \$17.05 |
| 265NC0327 | 266NC0327 | 267NC0327 | 5/8"-11 NC | 4 | H3 | 3-13/16" | 1-13/16" | 17/32" | \$20.12 |
| 265NF0328 | 266NF0328 | 267NF0328 | 5/8"-18 NF | 4 | H3 | 3-13/16" | 1-13/16" | 37/64" | \$20.12 |
| 265NS0329 | 266NS0329 | 267NS0329 | 11/16"-11 NS | 4 | H3 | 4-1/32" | 1-13/16" | 19/32" | \$21.70 |
| 265NS0330 | 266NS0330 | 267NS0330 | 11/16"-16 NS | 4 | H3 | 4-1/32" | 1-13/16" | 5/8" | \$21.70 |
| 265NC0331 | 266NC0331 | 267NC0331 | 3/4"-10 NC | 4 | H3 | 4-1/4" | 2" | 21/32" | \$32.10 |
| 265NF0332 | 266NF0332 | 267NF0332 | 3/4"-16 NF | 4 | H3 | 4-1/4" | 2" | 11/16" | \$32.10 |
| 265NC0333 | 266NC0333 | 267NC0333 | 7/8"-9 NC | 4 | H4 | 4-11/16" | 2-7/32" | 49/64" | \$44.78 |
| 265NF0334 | 266NF0334 | 267NF0334 | 7/8"-14 NF | 4 | H4 | 4-11/16" | 2-7/32" | 13/16" | \$44.78 |
| 265NC0335 | 266NC0335 | 267NC0335 | 1"-8 NC | 4 | H4 | 5-1/8" | 2-1/2" | 7/8" | \$60.28 |
| 265NF0336 | 266NF0336 | 267NF0336 | 1"-12 NF | 4 | H4 | 5-1/8" | 2-1/2" | 59/64" | \$60.28 |
| 265NS0337 | 266NS0337 | 267NS0337 | 1"-14 NS | 4 | H4 | 5-1/8" | 2-1/2" | 15/16" | \$60.28 |



5 PCS. PER
PACK FROM
4-40 TO
1/2"-20.
SOLD
1 PC.
OVER 1/2"-20.



- ◆ National Pipe Tap
- ◆ High Speed Steel
- ◆ Ground Thread
- ◆ Heavy Duty



**SOLD INDIVIDUALLY
IN PLASTIC TUBES**

(HSS) NPT Taper Pipe Taps

| Part # | Size | Threads Per Inch NPT Only | No. Of Flutes | OAL | Thread Length | List |
|-----------|--------|---------------------------|---------------|---------|---------------|----------|
| 265TP0464 | 1/16" | 27 | 4 | 2-1/8" | 11/16" | \$13.13 |
| 265TP0864 | 1/8" | 27 | 4 | 2-1/8" | 3/4" | \$13.13 |
| 265TP1664 | 1/4" | 18 | 4 | 2-7/16" | 1-1/16" | \$18.85 |
| 265TP2464 | 3/8" | 18 | 4 | 2-9/16" | 1-1/16" | \$23.81 |
| 265TP3264 | 1/2" | 14 | 4 | 3-1/8" | 1-3/8" | \$42.66 |
| 265TP4864 | 3/4" | 14 | 5 | 3-1/4" | 1-3/8" | \$63.49 |
| 265TP6464 | 1" | 11.5 | 5 | 3-3/4" | 1-3/4" | \$104.17 |
| 265TP8064 | 1-1/4" | 11.5 | 5 | 4" | 1-3/4" | \$151.42 |
| 265TP9664 | 1-1/2" | 11.5 | 7 | 4-1/4" | 1-3/4" | \$219.30 |
| 265TP9964 | 2" | 11.5 | 7 | 4-1/2" | 1-3/4" | \$308.63 |

- ◆ National Pipe Tap
- ◆ Carbon Steel
- ◆ Ground Thread
- ◆ General Purpose



**SOLD INDIVIDUALLY
IN PLASTIC TUBES**

(Carbon Steel) NPT Taper Pipe Taps

| Part # | Size | Threads Per Inch NPT Only | No. Of Flutes | OAL | Thread Length | List |
|---------|--------|---------------------------|---------------|---------|---------------|----------|
| NPT0464 | 1/16" | 27 | 4 | 2-1/8" | 11/16" | \$6.25 |
| NPT0864 | 1/8" | 27 | 4 | 2-1/8" | 3/4" | \$6.25 |
| NPT1664 | 1/4" | 18 | 4 | 2-7/16" | 1-1/16" | \$7.42 |
| NPT2464 | 3/8" | 18 | 4 | 2-9/16" | 1-1/16" | \$9.90 |
| NPT3264 | 1/2" | 14 | 4 | 3-1/8" | 1-3/8" | \$17.31 |
| NPT4864 | 3/4" | 14 | 5 | 3-1/4" | 1-3/8" | \$24.18 |
| NPT6464 | 1" | 11.5 | 5 | 3-3/4" | 1-3/4" | \$41.75 |
| NPT8864 | 1-1/4" | 11.5 | 5 | 4" | 1-3/4" | \$57.98 |
| NPT9664 | 1-1/2" | 11.5 | 7 | 4-1/4" | 1-3/4" | \$85.03 |
| NPT9964 | 2" | 11.5 | 7 | 4-1/2" | 1-3/4" | \$119.06 |

T-Handle Tap Wrench

| Part # | O.D. Size | List |
|-----------|------------|---------|
| 271TT0001 | #0 - 1/4" | \$11.76 |
| 271TT0002 | #10 - 1/2" | \$16.41 |



Tap Reamer Wrench

| Part # | O.D. Size | Size | List |
|-----------|---------------|------|---------|
| 270TW0000 | #0-1/4" | TW0 | \$12.43 |
| 270TW0004 | #0-3/8" | TW4 | \$17.32 |
| 270TW0005 | #7-1/2" | TW5 | \$21.09 |
| 270TW0006 | #7-3/4" | TW6 | \$29.75 |
| 270TW0007 | 1/4" → 1-1/8" | TW7 | \$57.64 |



NPT TAP-DRILL CHART



| DRILL THIS SIZE HOLE | | | TO TAP FOR THIS BOLT OR SCREW |
|----------------------|------------|------------------|-------------------------------|
| DECIMAL INCHES | DRILL SIZE | NEAREST FRACTION | |
| .3390" | Ltr. R | none | 1/8-27 NPT |
| .4375" | 7/16" | 7/16" | 1/4-18 NPT |
| .5781" | 37/64" | 37/64" | 3/8- 18 NPT |
| .7031" | 45/64" | 45/64" | 1/2-14 NPT |
| .9219" | 59/64" | 59/64" | 3/4-14 NPT |
| 1.1562" | 1-5/32" | 1-5/32" | 1 - 11-1/2 NPT |
| 1.5000" | 1-1/2" | 1-1/2" | 1-1/4 - 11-1/2 NPT |
| 1.7344" | 1-47/64" | 1-47/64" | 1-1/2 - 11-1/2 NPT |
| 2.2188" | 2-3/16" | 2-3/16" | 2 - 11-1/2 NPT |



Wrenches will accommodate all HSS & Carbon Hand Taps within O.D. size.
O.D. Size = Actual Tap Size (machine screw thread).

Combo Drill Taps - HSS

| Part # | Thread Size | Drill Size | Thread Length | OAL | List |
|-----------|-----------------|------------|---------------|--------|---------|
| 266TD0632 | 6-32 | 0.1095 | 11/16" | 2" | \$18.33 |
| 266TD0832 | 8-32 | 0.1360 | 3/4" | 2-1/8" | \$18.80 |
| 266TD0836 | 8-36 | 0.1360 | 3/4" | 2-1/8" | \$18.80 |
| 266TD1024 | 10-24 | 0.1520 | 7/8" | 2-3/8" | \$19.43 |
| 266TD1032 | 10-32 | 0.1520 | 7/8" | 2-3/8" | \$19.43 |
| 266TD1224 | 12-24 | 0.1770 | 15/16" | 2-3/8" | \$20.42 |
| 267TD1420 | 1/4"-20 | 0.2010 | 15/16" | 2-1/2" | \$22.70 |
| 267TD1428 | 1/4"-28 | 0.2010 | 15/16" | 2-1/2" | \$22.70 |
| 267TD5618 | 5/16"-18 | 0.2570 | 1-1/8" | 3" | \$27.26 |
| 267TD3816 | 3/8"-16 | 0.3125 | 1-1/4" | 3-1/2" | \$31.73 |
| 267TD3824 | 3/8"-24 | 0.3125 | 1-1/4" | 3-1/2" | \$31.73 |
| 267TD7614 | 7/16"-14 | 0.3680 | 1-7/16" | 3-7/8" | \$37.68 |
| 267TD1213 | 1/2"-13 | 0.4250 | 1-21/32" | 4-1/4" | \$44.54 |



- ◆ High Speed Steel
- ◆ Ground Thread
- ◆ Heavy Duty

Drill and Tap holes in one operation, saving a complete set-up!

**SOLD INDIVIDUALLY
IN PLASTIC TUBES**

Spiral Point (Gun) Taps - HSS

| Part # | Size | No. Of Flutes | OAL | Thread Length | Drill Size | List |
|-----------|-----------------|---------------|----------|---------------|------------|---------|
| 265SP0632 | 6-32 | 2 | 2" | 11/16" | 35 | \$5.77 |
| 265SP0832 | 8-32 | 2 | 2-1/8" | 3/4" | 29 | \$5.77 |
| 265SP1024 | 10-24 | 2 | 2-3/8" | 7/8" | 25 | \$5.77 |
| 265SP1032 | 10-32 | 2 | 2-3/8" | 7/8" | 25 | \$5.77 |
| 265SP1224 | 12-24 | 2 | 2-3/8" | 15/16" | 16 | \$6.02 |
| 265SP1420 | 1/4"-20 | 2 | 2-1/2" | 1" | 7 | \$6.02 |
| 265SP1428 | 1/4"-28 | 2 | 2-1/2" | 1" | 7 | \$6.02 |
| 265SP5618 | 5/16"-18 | 2 | 2-23/32" | 1-1/8" | F | \$6.78 |
| 265SP3816 | 3/8"-16 | 3 | 2-15/16" | 1-1/4" | 5/16" | \$7.74 |
| 265SP1312 | 1/2"-13 | 3 | 3-3/8" | 1-21/32" | 27/64" | \$14.31 |



- ◆ High Speed Steel
- ◆ Ground Thread
- ◆ Heavy Duty

Spiral Point Taps are ideal for machine tapping through holes or blind holes with adequate bottom clearance.



**Sold
5/Pack**

Spiral Point (Gun) Taps - HSS Made in USA

| Part # | Size | No. Of Flutes | OAL | Thread Length | Drill Size | List |
|----------|-----------------|---------------|----------|---------------|------------|---------|
| GUN-0632 | 6-32 | 2 | 2" | 11/16" | 35 | \$8.32 |
| GUN-0832 | 8-32 | 2 | 2-1/8" | 3/4" | 29 | \$8.55 |
| GUN-1024 | 10-24 | 2 | 2-3/8" | 7/8" | 25 | \$8.94 |
| GUN-1032 | 10-32 | 2 | 2-3/8" | 7/8" | 25 | \$8.94 |
| GUN-1224 | 12-24 | 2 | 2-3/8" | 15/16" | 16 | \$10.91 |
| GUN-1420 | 1/4"-20 | 2 | 2-1/2" | 1" | 7 | \$9.34 |
| GUN-1428 | 1/4"-28 | 2 | 2-1/2" | 1" | 7 | \$9.34 |
| GUN-5618 | 5/16"-18 | 2 | 2-23/32" | 1-1/8" | F | \$11.37 |
| GUN-3816 | 3/8"-16 | 3 | 2-15/16" | 1-1/4" | 5/16" | \$12.47 |
| GUN-1312 | 1/2"-13 | 3 | 3-3/8" | 1-21/32" | 27/64" | \$25.69 |
| GUN-3410 | 3/4"-10 | 3 | 3-3/8" | 1-21/32" | 27/64" | \$69.95 |



- ◆ High Speed Steel
- ◆ Ground Thread
- ◆ Heavy Duty



Made In



**Sold
5/Pack**



NEW
PACKAGING



- ◆ Individually Blister Packaged
- ◆ Industrial Quality
- Stainless Steel
- Ferrous Metals
- Non-Ferrous Metals
- ◆ 5/8" - 11 SPINDLE



Industrial Wire Cups

| Part # | Size | Description | Wire Type | List |
|--------|--------|-------------|----------------------|---------|
| KCC075 | 2-3/4" | Knotted Cup | .020 Carbon Steel | \$13.75 |
| KCS075 | 2-3/4" | Knotted Cup | .020 Stainless Steel | \$19.80 |
| KCC100 | 4" | Knotted Cup | .020 Carbon Steel | \$19.86 |
| KCC150 | 6" | Knotted Cup | .020 Carbon Steel | \$40.94 |
| CCC075 | 3" | Crimped Cup | .014 Carbon Steel | \$12.99 |
| CCC100 | 4" | Crimped Cup | .014 Carbon Steel | \$18.94 |

USE RED - NUT WIRE CUP
ADAPTER IN CLOCKWISE
ROTATION ONLY.



The Red-Nut Wire Cup Adapter

| Part # | Description | List |
|--------|------------------------------|---------|
| REDNUT | 5/8"-11 Bolt and Nut Adapter | \$35.00 |

- ◆ 3-Flat Shank
- ◆ For Use in 1/2" Handheld Drills
- ◆ Light Grinding





Stringer Bead Wheel

NEW PACKAGING



Industrial Wire Wheels

| Part # | Size | Description | Wire Type | List |
|--------|------|------------------------|---|----------|
| TKW100 | 4" | Twist Knot Wheel | .020 Carbon Steel | \$15.89 |
| SBW100 | 4" | Stringer Bead Wheel | .020 Carbon Steel | \$16.19 |
| SBS100 | 4" | Stringer Bead Wheel | .020 Stainless Steel | \$34.83 |
| SBW175 | 7" | Stringer Bead Wheel | .020 Carbon Steel | \$46.98 |
| WBB120 | 12" | Walk Behind Wire Brush | .020 Carbon Steel (1" Spindle) | \$108.08 |

- ◆ Individually Blister Packaged
- ◆ Industrial Quality
- ➔ Stainless Steel
- ➔ Ferrous Metals
- ➔ Non-Ferrous Metals
- ◆ **5/8" - 11 SPINDLE**

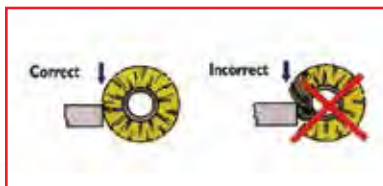

Hand Wire Brush

| Part # | Description | Material | List |
|--------|-----------------|--------------|--------|
| VIP100 | Hand Wire Brush | Carbon Steel | \$6.95 |

| APPLICATION | KNOTTED CUP WIRE BRUSH | CRIMPED CUP WIRE BRUSH | TWIST KNOT WIRE BRUSH | STRINGER BEAD WIRE BRUSH |
|---------------------|------------------------|------------------------|-----------------------|--------------------------|
| DEBURRING (FINE) | ⊗ | ⊗ | | |
| DEBURRING (COURSE) | | | ⊗ | ⊗ |
| EDGE BLENDING | ⊗ | ⊗ | | |
| WELD, SCALE REMOVAL | | | ⊗ | ⊗ |
| WELD PREP | | | | ⊗ |
| SURFACE FINISHING | ⊗ | ⊗ | | |
| RUST OXIDE (FINE) | ⊗ | ⊗ | | |
| RUST OXIDE (COARSE) | | | ⊗ | ⊗ |
| PAINT REMOVAL | ⊗ | ⊗ | | |
| ROUGHENING | ⊗ | ⊗ | ⊗ | ⊗ |
| CLEANING | ⊗ | ⊗ | | ⊗ |
| FLASH REMOVAL | | ⊗ | ⊗ | |
| TOOL MARK REMOVAL | | ⊗ | ⊗ | |
| EXPANSION JOINT | | ⊗ | ⊗ | |





Cylinder

| Part # | Dia. | Cut | Qty. | List |
|--------|------|------|------|---------|
| CBA-1 | 1/4" | 5/8" | 1 | \$17.12 |
| CBA-3 | 3/8" | 3/4" | 1 | \$24.07 |
| CBA-5 | 1/2" | 1" | 1 | \$37.76 |
| CBA-7 | 3/4" | 1" | 1 | \$81.55 |



Tree w/ Radius

| Part # | Dia. | Cut | Qty. | List |
|--------|------|------|------|---------|
| CBF-1 | 1/4" | 5/8" | 1 | \$25.98 |
| CBF-3 | 3/8" | 3/4" | 1 | \$32.78 |
| CBF-5 | 1/2" | 1" | 1 | \$47.20 |
| CBF-6 | 5/8" | 1" | 1 | \$67.09 |



14° Taper w/ Radius

| Part # | Dia. | Cut | Qty. | List |
|--------|------|---------|------|----------|
| CBL-1 | 1/4" | 5/8" | 1 | \$26.65 |
| CBL-3 | 3/8" | 1-1/16" | 1 | \$40.25 |
| CBL-4 | 1/2" | 1-1/8" | 1 | \$51.35 |
| CBL-5 | 5/8" | 1-3/16" | 1 | \$90.16 |
| CBL-7 | 3/4" | 1-1/2" | 1 | \$129.42 |



Cylinder w/ End Cut

| Part # | Dia. | Cut | Qty. | List |
|--------|------|------|------|---------|
| CBB-1 | 1/4" | 5/8" | 1 | \$23.18 |
| CBB-3 | 3/8" | 3/4" | 1 | \$33.27 |
| CBB-5 | 1/2" | 1" | 1 | \$51.75 |
| CBB-7 | 3/4" | 1" | 1 | \$92.53 |



Tree w/ Point

| Part # | Dia. | Cut | Qty. | List |
|--------|------|------|------|---------|
| CBG-1 | 1/4" | 5/8" | 1 | \$25.96 |
| CBG-3 | 3/8" | 3/4" | 1 | \$33.32 |
| CBG-5 | 1/2" | 1" | 1 | \$47.20 |



Pointed Cone

| Part # | Dia. | Cut | Qty. | List |
|--------|------|------|------|---------|
| CBM-2 | 1/4" | 3/4" | 1 | \$27.76 |
| CBM-4 | 3/8" | 5/8" | 1 | \$39.72 |
| CBM-5 | 1/2" | 7/8" | 1 | \$50.84 |



Cylinder w/ Radius

| Part # | Dia. | Cut | Qty. | List |
|--------|------|------|------|---------|
| CBC-1 | 1/4" | 5/8" | 1 | \$24.46 |
| CBC-3 | 3/8" | 3/4" | 1 | \$32.38 |
| CBC-5 | 1/2" | 1" | 1 | \$50.84 |
| CBC-6 | 5/8" | 1" | 1 | \$56.73 |



Flame

| Part # | Dia. | Cut | Qty. | List |
|--------|------|--------|------|---------|
| CBH-1 | 1/4" | 1/2" | 1 | \$29.21 |
| CBH-5 | 1/2" | 1-1/4" | 1 | \$65.06 |



Inverted Cone

| Part # | Dia. | Cut | Qty. | List |
|--------|------|-------|------|---------|
| CBN-1 | 1/4" | 5/16" | 1 | \$23.76 |
| CBN-2 | 3/8" | 3/8" | 1 | \$44.21 |
| CBN-4 | 1/2" | 1/2" | 1 | \$45.28 |

Made In



- ◆ Solid Carbide
- ◆ Bright Finish
- Ferrous Metals
- Cast Iron
- Steel 40-55 Rc
- Steel 55-60 Rc
- Nickel
- Stainless Steel
- Weldments

Better For:

- Brass
- Bronze
- Copper



Ball

| Part # | Dia. | Cut | Qty. | List |
|--------|------|------|------|---------|
| CBD-1 | 1/4" | 1/4" | 1 | \$22.21 |
| CBD-3 | 3/8" | 3/8" | 1 | \$25.97 |
| CBD-5 | 1/2" | 1/2" | 1 | \$35.17 |



Cone 60°

| Part # | Dia. | Cut | Qty. | List |
|--------|------|-------|------|---------|
| CBJ-1 | 1/4" | 3/16" | 1 | \$24.07 |
| CBJ-3 | 3/8" | 1/4" | 1 | \$29.61 |
| CBJ-5 | 1/2" | 7/16" | 1 | \$36.54 |



Oval

| Part # | Dia. | Cut | Qty. | List |
|--------|------|------|------|---------|
| CBE-1 | 1/4" | 3/8" | 1 | \$26.83 |
| CBE-3 | 3/8" | 5/8" | 1 | \$29.27 |
| CBE-5 | 1/2" | 7/8" | 1 | \$51.75 |
| CBE-6 | 5/8" | 1" | 1 | \$67.47 |



Cone 90°

| Part # | Dia. | Cut | Qty. | List |
|--------|------|------|------|---------|
| CBK-1 | 1/4" | 1/4" | 1 | \$24.64 |
| CBK-3 | 3/8" | 3/8" | 1 | \$30.36 |
| CBK-5 | 1/2" | 1/2" | 1 | \$36.54 |



Cylinder

| Part # | Dia. | Cut | Qty. | List |
|--------|------|------|------|---------|
| SA-1NF | 1/4" | 3/4" | 1 | \$19.25 |
| SA-3NF | 3/8" | 3/4" | 1 | \$27.96 |
| SA-5NF | 1/2" | 1" | 1 | \$42.17 |
| SA-6NF | 5/8" | 1" | 1 | \$50.10 |
| SA-7NF | 3/4" | 1" | 1 | \$69.58 |



Ball

| Part # | Dia. | Cut | Qty. | List |
|--------|------|------|------|---------|
| SD-1NF | 1/4" | 1/4" | 1 | \$18.47 |
| SD-3NF | 3/8" | 3/8" | 1 | \$25.30 |
| SD-5NF | 1/2" | 1/2" | 1 | \$35.84 |
| SD-6NF | 5/8" | 5/8" | 1 | \$45.33 |
| SD-7NF | 3/4" | 3/4" | 1 | \$60.64 |



Tree w/ Radius

| Part # | Dia. | Cut | Qty. | List |
|---------|------|--------|------|---------|
| SF-1NF | 1/4" | 3/4" | 1 | \$19.25 |
| SF-3NF | 3/8" | 3/4" | 1 | \$28.23 |
| SF-5NF | 1/2" | 1" | 1 | \$41.94 |
| SF-6NF | 5/8" | 1" | 1 | \$50.60 |
| SF-14NF | 3/4" | 1-1/4" | 1 | \$94.10 |



Cylinder w/ Radius

| Part # | Dia. | Cut | Qty. | List |
|--------|------|------|------|---------|
| SC-1NF | 1/4" | 3/4" | 1 | \$19.53 |
| SC-3NF | 3/8" | 3/4" | 1 | \$28.23 |
| SC-5NF | 1/2" | 1" | 1 | \$42.17 |
| SC-6NF | 5/8" | 1" | 1 | \$50.88 |
| SC-7NF | 3/4" | 1" | 1 | \$70.63 |



Oval

| Part # | Dia. | Cut | Qty. | List |
|--------|------|------|------|---------|
| SE-3NF | 3/8" | 5/8" | 1 | \$28.46 |
| SE-5NF | 1/2" | 7/8" | 1 | \$42.17 |
| SE-6NF | 5/8" | 1" | 1 | \$52.20 |
| SE-7NF | 3/4" | 1" | 1 | \$70.90 |



14° Taper w/ Radius

| Part # | Dia. | Cut | Qty. | List |
|--------|------|---------|------|----------|
| SL-3NF | 3/8" | 1-1/16" | 1 | \$34.01 |
| SL-4NF | 1/2" | 1-1/8" | 1 | \$43.77 |
| SL-6NF | 5/8" | 1-5/16" | 1 | \$78.83 |
| SL-7NF | 3/4" | 1-1/2" | 1 | \$108.08 |



Made In



- ◆ Solid Carbide
- ◆ Deep Flute
- ◆ Bright Finish

- ▲ Non-Ferrous (Soft) Metals
 - Aluminum
 - Zinc
 - Plastics

SOLID CARBIDE BURS



1/8"
5/32"
3/16"
7/32"
1/4"
9/32"
5/16"
11/32"
3/8"
13/32"
7/16"
15/32"
1/2"

274MC0001
13 Steps 1/8" - 1/2"
List \$44.00

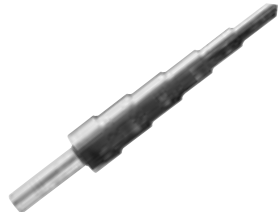

3/16"
1/4"
5/16"
3/8"
7/16"
1/2"

274MC0002
6 Steps 3/16" - 1/2"
List \$42.85



1/4"
5/16"
3/8"
7/16"
1/2"
9/16"
5/8"
11/16"
3/4"

274MC0003
9 Steps 1/4" - 3/4"
List \$53.27



3/16"
1/4"
5/16"
3/8"
7/16"
1/2"
9/16"
5/8"
11/16"
3/4"
13/16"
7/8"

274MC0004
12 Steps 3/16" - 7/8"
List \$59.58



7/16"
1/2"
9/16"
5/8"
11/16"
3/4"
13/16"
7/8"
15/16"
1"
1-1/16"
1-1/8"

274MC0005
12 Steps 7/16" - 1-1/8"
List \$84.83



3/4"
13/16"
7/8"
15/16"
1"
1-1/16"
1-1/8"
1-3/16"
1-1/4"
1-5/16"
1-3/8"

274MC0006
11 Steps 3/4" - 1-3/8"
List \$113.09



3/8"
7/16"
3/4"

For drilling 3 standard size holes to accommodate drive screws for knockout punches.

274MC0007
3 Steps 3/8" - 3/4"
List \$69.42



7/8"
1-1/8"

7/8" hole for 1/2" conduit.
1-1/8" hole for 3/4" conduit.

274MC0008
2 Steps 7/8" - 1-1/8"
List \$82.81



7/8"
1-1/8"
1-7/32"
1-1/4"
1-3/8"

1-7/32" hole for oil tight switches.

274MC0009
5 Steps 7/8" - 1-3/8"
List \$99.50



7/8"

274MC0010
1 Cone 7/8"
List \$59.58



1/4"
3/8"
1/2"
5/8"
3/4"
7/8"
1"
1-1/8"
1-1/4"
1-3/8"

3/16" Drilling Depth

274MC0011
10 Steps 1/4" - 1-3/8"
List \$106.33

THE BIG 10
One Size Fits All

- ◆ M2 HSS
 - ◆ Lobbed Non-Slip Shank
 - ◆ Drill 1/8" Thick
 - ◆ Double Flute
 - ◆ Bright Finish
- Ferrous & Non-Ferrous Sheet Metals
 - Plastic Laminates
 - Sink Grade Stainless Steel
 - Auto Body Repair
 - Electrical
 - HVAC
- STEP DRILLS ARE SOLD INDIVIDUALLY.

More accurate control of hole size in various sheet materials up to 1/8" thick. Each step bit drills a range of sizes. The further the bit advances, the larger the diameter of the hole gets. Because step drill bits enter the material one step at a time, the operator can drill the desired hole by counting the individual steps, or by using a washer as a simple stop. The self starting tip eliminates the need for pilot holes. Applications include junction boxes, switch boxes, metal studs, electrical applications, lighting fixtures, auto body work, and many other uses.



274HEX01
13 Steps 1/8" - 1/2"
 List \$45.32

1/8"
 5/32"
 3/16"
 7/32"
 1/4"
 9/32"
 5/16"
 11/32"
 3/8"
 13/32"
 7/16"
 15/32"
 1/2"



274HEX02
6 Steps 3/16" - 1/2"
 List \$44.13

3/16"
 1/4"
 5/16"
 3/8"
 7/16"
 1/2"



274HEX03
9 Steps 1/4" - 3/4"
 List \$54.87

1/4"
 5/16"
 3/8"
 7/16"
 1/2"
 9/16"
 5/8"
 11/16"
 3/4"



274HEX04
12 Steps 3/16" - 7/8"
 List \$70.57

3/16"
 1/4"
 5/16"
 3/8"
 7/16"
 1/2"
 9/16"
 5/8"
 11/16"
 3/4"
 13/16"
 7/8"



274HEX05
12 Steps 7/16" - 1-1/8"
 List \$100.48

7/16"
 1/2"
 9/16"
 5/8"
 11/16"
 3/4"
 13/16"
 7/8"
 15/16"
 1"
 1-1/16"
 1-1/8"



274HEX08
2 Steps 7/8" - 1-1/8"
 List \$98.09

7/8"
 1-1/8"
 7/8" hole for 1/2" conduit.
 1-1/8" hole for 3/4" conduit.



IMPACT
 1/4" HEX IMPACT SHANK

M2 HSS

FAST SPIRAL

STEP DRILL

- ◆ M2 HSS
- ◆ Fast Spiral Flutes
- ◆ Jam Free Performance
- ◆ Self Starting Split Point
- ◆ Bright Finish
- Ferrous & Non-Ferrous Sheet Metals
- Plastic Laminates
- Sink Grade Stainless Steel
- Auto Body Repair
- Electrical
- HVAC





BLACK Oxide

- ◆ High Speed Steel (HSS)
- ◆ Tapered Point
- ◆ Left-Hand Spiral
- ◆ Right-Hand Cut
- ◆ 3-Flat Shank

Made in Europe



3-FLAT SHANK

Reamer - CAR / Construction - Spiral Flute - HSS

| Part # | Size | Point Diameter | OAL | Flute | Shank | Type | List |
|----------|---------|----------------|--------|--------|-------|----------------------|----------|
| CRF-2464 | 3/8" | 0.250 | 5" | 4" | 3/8" | 3-Flat Car / Constr. | \$46.05 |
| CRF-2864 | 7/16" | 0.281 | 5-1/4" | 4" | 7/16" | 3-Flat Car / Constr. | \$52.07 |
| CRF-3264 | 1/2" | 0.343 | 6" | 4-1/2" | 1/2" | 3-Flat Car / Constr. | \$59.10 |
| CRF-3664 | 9/16" | 0.343 | 6-1/4" | 4-1/2" | 1/2" | 3-Flat Car / Constr. | \$62.56 |
| CRF-4064 | 5/8" | 0.343 | 6-1/2" | 4-1/2" | 1/2" | 3-Flat Car / Constr. | \$69.03 |
| CRF-4464 | 11/16" | 0.375 | 7" | 4-1/2" | 1/2" | 3-Flat Car / Constr. | \$79.86 |
| CRF-4864 | 3/4" | 0.406 | 7-1/4" | 5" | 1/2" | 3-Flat Car / Constr. | \$92.10 |
| CRF-5264 | 13/16" | 0.468 | 7-1/4" | 5" | 1/2" | 3-Flat Car / Constr. | \$97.66 |
| CRF-5664 | 7/8" | 0.500 | 7-1/4" | 5" | 1/2" | 3-Flat Car / Constr. | \$109.48 |
| CRF-6064 | 15/16" | 0.585 | 7-1/4" | 5" | 1/2" | 3-Flat Car / Constr. | \$122.30 |
| CRF-6464 | 1" | 0.594 | 7-1/4" | 5" | 1/2" | 3-Flat Car / Constr. | \$129.64 |
| CRF-6864 | 1-1/16" | 0.807 | 7-1/4" | 5" | 1/2" | 3-Flat Car / Constr. | \$150.10 |

Reaming Steel For Aligning Existing Holes & Bolt / Rivet Installation

BLACK Oxide

- ◆ High Speed Steel (HSS)
- ◆ Tapered Point
- ◆ Left-Hand Spiral
- ◆ Right-Hand Cut
- ◆ 3-Flat Shank

Made in Europe



3-FLAT SHANK

Reamer - CAR / Construction - *Fast Spiral* - HSS

| Part # | Size | Point Diameter | OAL | Flute | Shank | Type | List |
|----------|--------|----------------|--------|--------|-------|----------------------|----------|
| CFF-2464 | 3/8" | 0.250 | 5" | 4" | 3/8" | 3-Flat Car / Constr. | \$77.07 |
| CFF-3264 | 1/2" | 0.343 | 6" | 4-1/2" | 1/2" | 3-Flat Car / Constr. | \$91.75 |
| CFF-3664 | 9/16" | 0.343 | 6-1/4" | 4-1/2" | 1/2" | 3-Flat Car / Constr. | \$97.43 |
| CFF-4064 | 5/8" | 0.343 | 6-1/2" | 4-1/2" | 1/2" | 3-Flat Car / Constr. | \$106.76 |
| CFF-4464 | 11/16" | 0.375 | 7" | 4-1/2" | 1/2" | 3-Flat Car / Constr. | \$118.78 |
| CFF-4864 | 3/4" | 0.406 | 7-1/4" | 5" | 1/2" | 3-Flat Car / Constr. | \$141.86 |
| CFF-5264 | 13/16" | 0.468 | 7-1/4" | 5" | 1/2" | 3-Flat Car / Constr. | \$145.45 |
| CFF-5664 | 7/8" | 0.500 | 7-1/4" | 5" | 1/2" | 3-Flat Car / Constr. | \$160.81 |
| CFF-6064 | 15/16" | 0.585 | 7-1/4" | 5" | 1/2" | 3-Flat Car / Constr. | \$160.81 |
| CFF-6464 | 1" | 0.594 | 7-1/4" | 5" | 1/2" | 3-Flat Car / Constr. | \$188.17 |
| CFF-8064 | 1-1/4" | 0.719 | 7-1/4" | 5" | 1/2" | 3-Flat Car / Constr. | \$293.59 |



Reamer - CAR / Construction - Spiral Flute - HEX - HSS

| Part # | Size | Point Diameter | OAL | Flute | Shank | Type | List |
|----------|---------|----------------|--------|--------|---------|---------|----------|
| CHX-4464 | 11/16" | 0.375 | 6-3/8" | 4-1/2" | 1-1/16" | HEX Car | \$78.66 |
| CHX-5264 | 13/16" | 0.468 | 7" | 5" | 1-1/4" | HEX Car | \$93.22 |
| CHX-6064 | 15/16" | 0.585 | 7" | 5" | 1-7/16" | HEX Car | \$110.81 |
| CHX-6864 | 1-1/16" | 0.807 | 7" | 5" | 1-5/8" | HEX Car | \$143.87 |

- ◆ High Speed Steel (HSS)
- ◆ Tapered Point
- ◆ Left-Hand Spiral
- ◆ Right-Hand Cut
- ◆ HEX Nut Shank

Made in Europe

Reaming Steel For Aligning Existing Holes & Bolt / Rivet Installation



Reamer - BRIDGE - Spiral Flute - HEX - HSS

| Part # | Size | Point Diameter | OAL | Flute | Shank | Type | List |
|----------|---------|----------------|--------|--------|---------|------------|----------|
| CBB-4464 | 11/16" | 0.375 | 6-3/8" | 4-1/2" | 1-1/16" | HEX Bridge | \$104.38 |
| CBB-5264 | 13/16" | 0.468 | 7" | 5" | 1-1/4" | HEX Bridge | \$131.88 |
| CBB-6064 | 15/16" | 0.585 | 7" | 5" | 1-7/16" | HEX Bridge | \$156.75 |
| CBB-6864 | 1-1/16" | 0.807 | 7" | 5" | 1-5/8" | HEX Bridge | \$213.34 |

- ◆ High Speed Steel (HSS)
- ◆ Tapered Point
- ◆ Left-Hand Spiral
- ◆ Right-Hand Cut
- ◆ HEX Nut Shank

Made in Europe



Bridge Construction



Ship Building



Structural Steel Erection

Reaming Steel For Aligning Existing Holes & Bolt / Rivet Installation



Made In



Black & Gold

- ◆ High Speed Steel (HSS)
- ◆ Tapered Point
- ◆ Left-Hand Spiral
- ◆ Right-Hand Cut
- ◆ 3-Flat Shank
- Structural Plate



3-FLAT SHANK

Reamer - CAR / Construction - Spiral Flute - HSS

| Part # | Size | Point Diameter | OAL | Flute | Shank | Type | List |
|----------|--------|----------------|--------|--------|-------|----------------------|----------|
| ASF-2464 | 3/8" | 0.250 | 5" | 4" | 3/8" | 3-Flat Car / Constr. | \$73.37 |
| ASF-3264 | 1/2" | 0.281 | 6" | 4-1/2" | 1/2" | 3-Flat Car / Constr. | \$87.39 |
| ASF-3664 | 9/16" | 0.343 | 6-1/4" | 4-1/2" | 1/2" | 3-Flat Car / Constr. | \$93.01 |
| ASF-4064 | 5/8" | 0.343 | 6-1/2" | 4-1/2" | 1/2" | 3-Flat Car / Constr. | \$101.49 |
| ASF-4464 | 11/16" | 0.375 | 7" | 4-1/2" | 1/2" | 3-Flat Car / Constr. | \$112.81 |
| ASF-4864 | 3/4" | 0.406 | 7-1/4" | 5" | 1/2" | 3-Flat Car / Constr. | \$135.35 |
| ASF-5264 | 13/16" | 0.468 | 7-1/4" | 5" | 1/2" | 3-Flat Car / Constr. | \$138.71 |
| ASF-5664 | 7/8" | 0.500 | 7-1/4" | 5" | 1/2" | 3-Flat Car / Constr. | \$152.90 |
| ASF-6064 | 15/16" | 0.585 | 7-1/4" | 5" | 1/2" | 3-Flat Car / Constr. | \$152.90 |
| ASF-6464 | 1" | 0.594 | 7-1/4" | 5" | 1/2" | 3-Flat Car / Constr. | \$179.37 |
| ASF-8064 | 1-1/4" | 0.719 | 7-1/4" | 5" | 1/2" | 3-Flat Car / Constr. | \$280.24 |

Made In



Black & Gold

- ◆ High Speed Steel (HSS)
- ◆ Tapered Point
- ◆ Left-Hand Spiral
- ◆ Right-Hand Cut
- ◆ 3-Flat Shank
- Structural Plate



3-FLAT SHANK

Reamer - CAR / Construction - *Fast Spiral* - HSS

| Part # | Size | Point Diameter | OAL | Flute | Shank | Type | List |
|----------|--------|----------------|--------|--------|-------|----------------------|----------|
| AFC-2464 | 3/8" | 0.250 | 5" | 4" | 3/8" | 3-Flat Car / Constr. | \$80.92 |
| AFC-3264 | 1/2" | 0.281 | 6" | 4-1/2" | 1/2" | 3-Flat Car / Constr. | \$96.34 |
| AFC-3664 | 9/16" | 0.343 | 6-1/4" | 4-1/2" | 1/2" | 3-Flat Car / Constr. | \$102.30 |
| AFC-4064 | 5/8" | 0.343 | 6-1/2" | 4-1/2" | 1/2" | 3-Flat Car / Constr. | \$112.10 |
| AFC-4464 | 11/16" | 0.375 | 7" | 4-1/2" | 1/2" | 3-Flat Car / Constr. | \$124.72 |
| AFC-4864 | 3/4" | 0.406 | 7-1/4" | 5" | 1/2" | 3-Flat Car / Constr. | \$148.96 |
| AFC-5264 | 13/16" | 0.468 | 7-1/4" | 5" | 1/2" | 3-Flat Car / Constr. | \$152.73 |
| AFC-5664 | 7/8" | 0.500 | 7-1/4" | 5" | 1/2" | 3-Flat Car / Constr. | \$168.85 |
| AFC-6064 | 15/16" | 0.585 | 7-1/4" | 5" | 1/2" | 3-Flat Car / Constr. | \$168.85 |
| AFC-6464 | 1" | 0.594 | 7-1/4" | 5" | 1/2" | 3-Flat Car / Constr. | \$197.58 |
| AFC-8064 | 1-1/4" | 0.719 | 7-1/4" | 5" | 1/2" | 3-Flat Car / Constr. | \$308.27 |

Made In



Black & Gold

- ◆ High Speed Steel (HSS)
- ◆ Tapered Point
- ◆ Left-Hand Spiral
- ◆ Right-Hand Cut
- ◆ HEX Shank
- Structural Plate



Reamer - CAR - Spiral Flute - *HEX* - HSS

| Part # | Size | Point Diameter | OAL | Flute | Shank | Type | List |
|----------|---------|----------------|--------|--------|---------|---------|----------|
| ACX-4464 | 11/16" | 0.375 | 6-3/8" | 4-1/2" | 1-1/16" | HEX Car | \$132.42 |
| ACX-5264 | 13/16" | 0.468 | 7" | 5" | 1-1/4" | HEX Car | \$158.70 |
| ACX-6064 | 15/16" | 0.585 | 7" | 5" | 1-7/16" | HEX Car | \$179.57 |
| ACX-6864 | 1-1/16" | 0.807 | 7" | 5" | 1-5/8" | HEX Car | \$235.12 |



Made In



Black & Gold

- ◆ High Speed Steel (HSS)
- ◆ Tapered Point
- ◆ Left-Hand Spiral
- ◆ Right-Hand Cut
- ◆ HEX Shank

- ➔ Structural Plate

Reamer - BRIDGE - Spiral Flute - HEX - HSS

| Part # | Size | Point Diameter | OAL | Flute | Shank | Type | List |
|----------|---------|----------------|--------|--------|---------|------------|----------|
| ABX-4464 | 11/16" | 0.375 | 9-1/4" | 7-1/8" | 1-1/16" | HEX Bridge | \$161.76 |
| ABX-5264 | 13/16" | 0.468 | 9-3/8" | 7-3/8" | 1-1/4" | HEX Bridge | \$184.05 |
| ABX-6064 | 15/16" | 0.585 | 9-3/8" | 7-3/8" | 1-7/16" | HEX Bridge | \$209.16 |
| ABX-6864 | 1-1/16" | 0.807 | 9-3/8" | 7-3/8" | 1-5/8" | HEX Bridge | \$258.57 |



Made In



Black & Gold

- ◆ High Speed Steel (HSS)
- ◆ Tapered Point
- ◆ Left-Hand Spiral
- ◆ Right-Hand Cut
- ◆ Taper Shank

- ➔ Structural Steel Assemblies
- ➔ Bridge Erection
- ➔ Ship Construction

Reamer - BRIDGE - Straight Flute - Morse Taper - HSS

| Part # | Size | Point Diameter | OAL | Flute | Shank | Type | List |
|----------|---------|----------------|---------|--------|----------|-------------------|----------|
| ABT-4464 | 11/16" | 0.375 | 11-3/4" | 7-1/8" | #3 Taper | Bridge - Straight | \$134.98 |
| ABT-5264 | 13/16" | 0.468 | 12" | 7-3/8" | #3 Taper | Bridge - Straight | \$154.90 |
| ABT-6064 | 15/16" | 0.585 | 12" | 7-3/8" | #3 Taper | Bridge - Straight | \$176.11 |
| ABT-6864 | 1-1/16" | 0.807 | 12" | 7-3/8" | #3 Taper | Bridge - Straight | \$217.65 |



Reamer - BRIDGE - Spiral Flute - Morse Taper - HSS

| Part # | Size | Point Diameter | OAL | Flute | Shank | Type | List |
|----------|---------|----------------|---------|--------|----------|-----------------|----------|
| AFF-4464 | 11/16" | 0.375 | 11-3/4" | 7-1/8" | #3 Taper | Bridge - Spiral | \$134.98 |
| AFF-5264 | 13/16" | 0.468 | 12" | 7-3/8" | #3 Taper | Bridge - Spiral | \$134.35 |
| AFF-6064 | 15/16" | 0.585 | 12" | 7-3/8" | #3 Taper | Bridge - Spiral | \$165.24 |
| AFF-6864 | 1-1/16" | 0.807 | 12" | 7-3/8" | #3 Taper | Bridge - Spiral | \$222.84 |



1" Cutting Depth



2" Cutting Depth

1" HSS Annular Cutter

| Part # | Size | x | Depth | List |
|-----------|----------|---|-------|----------|
| 100MC2864 | 7/16" | X | 1" | \$50.71 |
| 100MC3264 | 1/2" | X | 1" | \$50.71 |
| 100MC3664 | 9/16" | X | 1" | \$53.01 |
| 100MC4064 | 5/8" | X | 1" | \$57.18 |
| 100MC4464 | 11/16" | X | 1" | \$61.50 |
| 100MC4864 | 3/4" | X | 1" | \$62.87 |
| 100MC5264 | 13/16" | X | 1" | \$70.02 |
| 100MC5664 | 7/8" | X | 1" | \$76.00 |
| 100MC6064 | 15/16" | X | 1" | \$78.69 |
| 100MC6464 | 1" | X | 1" | \$88.05 |
| 100MC6864 | 1-1/16" | X | 1" | \$102.12 |
| 100MC7264 | 1-1/8" | X | 1" | \$111.67 |
| 100MC7664 | 1-3/16" | X | 1" | \$113.97 |
| 100MC8064 | 1-1/4" | X | 1" | \$116.13 |
| 100MC8464 | 1-5/16" | X | 1" | \$133.80 |
| 100MC8864 | 1-3/8" | X | 1" | \$153.08 |
| 100MC9264 | 1-7/16" | X | 1" | \$170.71 |
| 100MC9664 | 1-1/2" | X | 1" | \$201.00 |
| 100MC1916 | 1-9/16" | X | 1" | \$205.61 |
| 100MC1058 | 1-5/8" | X | 1" | \$208.16 |
| 100MC1116 | 1-11/16" | X | 1" | \$210.07 |
| 100MC1034 | 1-3/4" | X | 1" | \$214.18 |
| 100MC1316 | 1-13/16" | X | 1" | \$221.48 |
| 100MC1078 | 1-7/8" | X | 1" | \$230.74 |
| 100MC1516 | 1-15/16" | X | 1" | \$239.27 |
| 100MC2002 | 2" | X | 1" | \$280.48 |
| 100MC2116 | 2-1/16" | X | 1" | \$452.71 |

2" HSS Annular Cutter

| Part # | Size | x | Depth | List |
|-----------|----------|---|-------|----------|
| 200MC2864 | 7/16" | X | 2" | \$68.65 |
| 200MC3264 | 1/2" | X | 2" | \$68.65 |
| 200MC3664 | 9/16" | X | 2" | \$70.95 |
| 200MC4064 | 5/8" | X | 2" | \$78.79 |
| 200MC4464 | 11/16" | X | 2" | \$87.63 |
| 200MC4864 | 3/4" | X | 2" | \$93.05 |
| 200MC5264 | 13/16" | X | 2" | \$102.12 |
| 200MC5664 | 7/8" | X | 2" | \$118.62 |
| 200MC6064 | 15/16" | X | 2" | \$120.54 |
| 200MC6464 | 1" | X | 2" | \$124.53 |
| 200MC6864 | 1-1/16" | X | 2" | \$129.17 |
| 200MC7264 | 1-1/8" | X | 2" | \$157.19 |
| 200MC7664 | 1-3/16" | X | 2" | \$163.56 |
| 200MC8064 | 1-1/4" | X | 2" | \$179.59 |
| 200MC8464 | 1-5/16" | X | 2" | \$194.33 |
| 200MC8864 | 1-3/8" | X | 2" | \$210.95 |
| 200MC9264 | 1-7/16" | X | 2" | \$225.20 |
| 200MC9664 | 1-1/2" | X | 2" | \$232.51 |
| 200MC1916 | 1-9/16" | X | 2" | \$267.39 |
| 200MC1058 | 1-5/8" | X | 2" | \$276.95 |
| 200MC1116 | 1-11/16" | X | 2" | \$288.66 |
| 200MC1034 | 1-3/4" | X | 2" | \$300.08 |
| 200MC1316 | 1-13/16" | X | 2" | \$312.75 |
| 200MC1078 | 1-7/8" | X | 2" | \$325.05 |
| 200MC1516 | 1-15/16" | X | 2" | \$367.79 |
| 200MC2002 | 2" | X | 2" | \$386.51 |
| 200MC2116 | 2-1/16" | X | 2" | \$554.09 |

- ◆ M2 HSS
- ◆ 3/4" Weldon Shanks
- ◆ Aggressive Cutting Edges
- ◆ No Center Punch Required
- ◆ Cut up to 2"
- ◆ For All Magnetic Drills

- Steel
- Stainless Steel
- Castings



ENGLAND



Allows overlap cut on existing holes



Pilot Pins

| Part # | Description | List |
|---------|-------------------------------------|---------|
| PJ00011 | Pilot 1" Cutter | \$12.95 |
| PJ00021 | Pilot 2" Cutter | \$15.75 |
| PJ00716 | Pilot 7/16" x 1" Cutter ONLY | \$12.95 |
| PJ02716 | Pilot 7/16" x 2" Cutter ONLY | \$15.75 |



Arbor Adapters

| Part # | Description | List |
|--------|-------------|----------|
| AD0002 | Morse #2 | \$370.30 |
| AD0003 | Morse #3 | \$380.03 |

Converts Morse Tapers to 3/4" Arbor for All **ITM** and Conventional Annular Cutters.



1-3/8" Cutting Depth

1-3/8" TCT Annular Cutter

| Part # | Size | x | Depth | List |
|-----------|---------|---|--------|----------|
| ATAC-3264 | 1/2" | X | 1-3/8" | \$95.87 |
| ATAC-3664 | 9/16" | X | 1-3/8" | \$97.92 |
| ATAC-4064 | 5/8" | X | 1-3/8" | \$98.86 |
| ATAC-4464 | 11/16" | X | 1-3/8" | \$99.65 |
| ATAC-4864 | 3/4" | X | 1-3/8" | \$100.79 |
| ATAC-5264 | 13/16" | X | 1-3/8" | \$102.25 |
| ATAC-5664 | 7/8" | X | 1-3/8" | \$105.73 |
| ATAC-6064 | 15/16" | X | 1-3/8" | \$106.95 |
| ATAC-6464 | 1" | X | 1-3/8" | \$110.15 |
| ATAC-6864 | 1-1/16" | X | 1-3/8" | \$118.32 |
| ATAC-7264 | 1-1/8" | X | 1-3/8" | \$120.26 |
| ATAC-8864 | 1-3/8" | X | 1-3/8" | \$141.95 |
| ATAC-9264 | 1-7/16" | X | 1-3/8" | \$162.80 |
| ATAC-9664 | 1-1/2" | X | 1-3/8" | \$165.90 |

2" Cutting Depth

2" TCT Annular Cutter

| Part # | Size | x | Depth | List |
|-----------|---------|---|-------|----------|
| BTAC-3264 | 1/2" | X | 2" | \$108.19 |
| BTAC-3664 | 9/16" | X | 2" | \$108.81 |
| BTAC-4064 | 5/8" | X | 2" | \$109.17 |
| BTAC-4464 | 11/16" | X | 2" | \$111.62 |
| BTAC-4864 | 3/4" | X | 2" | \$113.41 |
| BTAC-5264 | 13/16" | X | 2" | \$114.53 |
| BTAC-5664 | 7/8" | X | 2" | \$116.31 |
| BTAC-6064 | 15/16" | X | 2" | \$118.38 |
| BTAC-6464 | 1" | X | 2" | \$120.26 |
| BTAC-6864 | 1-1/16" | X | 2" | \$132.52 |
| BTAC-7264 | 1-1/8" | X | 2" | \$133.61 |
| BTAC-8864 | 1-3/8" | X | 2" | \$158.09 |
| BTAC-9264 | 1-7/16" | X | 2" | \$179.78 |
| BTAC-9664 | 1-1/2" | X | 2" | \$186.30 |
| BTAC-2002 | 2" | X | 2" | \$255.54 |



- ◆ Tungsten Carbide Teeth
- ◆ 3/4" Weldon Shanks
- ◆ Aggressive Cutting Edges
- ◆ No Center Punch Required
- ◆ For All Magnetic Drills

- Steel
- Stainless Steel
- Castings



3" Cutting Depth

3" TCT Annular Cutter

| Part # | Size | x | Depth | List |
|-----------|---------|---|-------|----------|
| CTAC-3264 | 1/2" | X | 3" | \$159.13 |
| CTAC-3664 | 9/16" | X | 3" | \$162.00 |
| CTAC-4064 | 5/8" | X | 3" | \$170.62 |
| CTAC-4464 | 11/16" | X | 3" | \$174.35 |
| CTAC-4864 | 3/4" | X | 3" | \$180.17 |
| CTAC-5264 | 13/16" | X | 3" | \$182.26 |
| CTAC-5664 | 7/8" | X | 3" | \$185.12 |
| CTAC-6064 | 15/16" | X | 3" | \$187.53 |
| CTAC-6464 | 1" | X | 3" | \$191.22 |
| CTAC-6864 | 1-1/16" | X | 3" | \$208.90 |
| CTAC-7264 | 1-1/8" | X | 3" | \$211.82 |
| CTAC-8864 | 1-3/8" | X | 3" | \$234.77 |
| CTAC-9664 | 1-1/2" | X | 3" | \$285.27 |
| CTAC-2002 | 2" | X | 3" | \$382.19 |

4" Cutting Depth

4" TCT Annular Cutter

| Part # | Size | x | Depth | List |
|-----------|---------|---|-------|----------|
| RTAC-4864 | 3/4" | X | 4" | \$218.39 |
| RTAC-5264 | 13/16" | X | 4" | \$218.39 |
| RTAC-5664 | 7/8" | X | 4" | \$218.39 |
| RTAC-6064 | 15/16" | X | 4" | \$218.39 |
| RTAC-6464 | 1" | X | 4" | \$218.39 |
| RTAC-6864 | 1-1/16" | X | 4" | \$249.83 |
| RTAC-7264 | 1-1/8" | X | 4" | \$249.83 |
| RTAC-8864 | 1-3/8" | X | 4" | \$285.27 |
| RTAC-9664 | 1-1/2" | X | 4" | \$353.55 |
| RTAC-1058 | 1-5/8" | X | 4" | \$399.96 |
| RTAC-1034 | 1-3/4" | X | 4" | \$399.96 |
| RTAC-2002 | 2" | X | 4" | \$470.94 |

Similar to Annular Cutters, designed with Tungsten Carbide Teeth (TCT) for much faster deep drilling.



Allows overlap cut on existing holes

- **Cut Faster**
- **Cut Cleaner**
- **Lasts Longer**

Pilot Pins

| Part # | Depth | Cutter | List |
|--------|--------|-----------------|---------|
| PT-10 | 1-3/8" | 1/2" - 5/8" | \$12.59 |
| PT-12 | 1-3/8" | 11/16" - 1-1/2" | \$11.49 |
| PT-20 | 2" | 1/2" - 5/8" | \$12.59 |
| PT-22 | 2" | 11/16" - 2" | \$13.40 |
| PT-30 | 3" | 1/2" - 5/8" | \$18.39 |
| PT-32 | 3" | 11/16" - 2" | \$20.67 |
| PT-40 | 4" | 3/4" - 2" | \$25.72 |





3/16" Cutting Depth



1/2" Cutting Depth

T.C.T. Hole Cutter

| Part # | Size | Cut | Shank | List |
|--------|---------|-------|-------|----------|
| HF0012 | 5/8" | 3/16" | 3/8" | \$31.50 |
| HF0013 | 11/16" | 3/16" | 3/8" | \$31.50 |
| HF0014 | 3/4" | 3/16" | 3/8" | \$35.02 |
| HF0015 | 13/16" | 3/16" | 3/8" | \$35.02 |
| HF0016 | 7/8" | 3/16" | 3/8" | \$35.02 |
| HF0017 | 15/16" | 3/16" | 3/8" | \$35.02 |
| HF0018 | 1" | 3/16" | 3/8" | \$35.02 |
| HF0119 | 1-1/16" | 3/16" | 3/8" | \$38.89 |
| HF0019 | 1-1/8" | 3/16" | 3/8" | \$38.89 |
| HF0021 | 1-1/4" | 3/16" | 3/8" | \$45.00 |
| HF0023 | 1-3/8" | 3/16" | 3/8" | \$45.00 |
| HF0024 | 1-1/2" | 3/16" | 3/8" | \$52.22 |
| HF0025 | 1-5/8" | 3/16" | 3/8" | \$61.25 |
| HF0026 | 1-3/4" | 3/16" | 3/8" | \$61.25 |
| HF0027 | 1-7/8" | 3/16" | 3/8" | \$62.00 |
| HF0028 | 2" | 3/16" | 3/8" | \$69.50 |
| HF0029 | 2-1/8" | 3/16" | 3/8" | \$69.50 |
| HF0030 | 2-1/4" | 3/16" | 3/8" | \$87.78 |
| HF0032 | 2-3/8" | 3/16" | 3/8" | \$87.78 |
| HF0033 | 2-1/2" | 3/16" | 1/2" | \$103.89 |
| HF0135 | 2-3/4" | 3/16" | 1/2" | \$111.67 |
| HF0035 | 3" | 3/16" | 1/2" | \$123.50 |
| HF0138 | 3-1/4" | 3/16" | 1/2" | \$138.81 |
| HF0036 | 3-1/2" | 3/16" | 1/2" | \$148.83 |
| HF0140 | 3-5/8" | 3/16" | 1/2" | \$168.13 |
| HF0037 | 4" | 3/16" | 1/2" | \$175.00 |

T.C.T. Hole Cutter

| Part # | Size | Cut | Shank | List |
|---------|---------|------|-------|----------|
| HG0011 | 9/16" | 1/2" | 3/8" | \$41.67 |
| HG0012 | 5/8" | 1/2" | 3/8" | \$41.67 |
| HG0013 | 11/16" | 1/2" | 3/8" | \$41.67 |
| HG0014 | 3/4" | 1/2" | 3/8" | \$46.75 |
| HG0015 | 13/16" | 1/2" | 3/8" | \$46.75 |
| HG0016 | 7/8" | 1/2" | 3/8" | \$46.75 |
| HG0017 | 15/16" | 1/2" | 3/8" | \$46.75 |
| HG0018 | 1" | 1/2" | 3/8" | \$46.75 |
| HG0119 | 1-1/16" | 1/2" | 3/8" | \$54.17 |
| HG0019 | 1-1/8" | 1/2" | 3/8" | \$54.17 |
| HG0020 | 1-3/16" | 1/2" | 3/8" | \$54.17 |
| HG0021 | 1-1/4" | 1/2" | 3/8" | \$63.19 |
| HG0023 | 1-3/8" | 1/2" | 3/8" | \$63.19 |
| HG0024 | 1-1/2" | 1/2" | 3/8" | \$72.92 |
| HG0025 | 1-5/8" | 1/2" | 3/8" | \$84.72 |
| HG0026 | 1-3/4" | 1/2" | 3/8" | \$84.72 |
| HG0027 | 1-7/8" | 1/2" | 3/8" | \$84.94 |
| HG0028 | 2" | 1/2" | 3/8" | \$94.72 |
| HG0029 | 2-1/8" | 1/2" | 3/8" | \$94.72 |
| HG0030 | 2-1/4" | 1/2" | 3/8" | \$108.17 |
| HG0032 | 2-3/8" | 1/2" | 3/8" | \$108.17 |
| HG0033 | 2-1/2" | 1/2" | 1/2" | \$127.11 |
| HG0135 | 2-3/4" | 1/2" | 1/2" | \$137.50 |
| HG0035 | 3" | 1/2" | 1/2" | \$159.50 |
| HG0138 | 3-1/4" | 1/2" | 1/2" | \$162.78 |
| HG0036 | 3-1/2" | 1/2" | 1/2" | \$174.44 |
| HG0037* | 4" | 1/2" | 1/2" | \$215.11 |
| HG0040* | 4-1/2" | 1/2" | 1/2" | \$249.24 |
| HG0050* | 5" | 1/2" | 1/2" | \$265.25 |

- ◆ Excellent Wear and Heat Resistance
- ◆ Tungsten Carbide Teeth
- ◆ Cuts Stainless Steel and Tough Alloys
- ◆ Ejects the Slug Saving Time
- ◆ Works in 3/8" & 1/2" Chucks
- ◆ Made In Taiwan

- ➔ Sheet Metal
- ➔ Steel Plate
- ➔ Stainless Steel
- ➔ Copper
- ➔ Cast Iron



T.C.T. HOLE CUTTERS ARE SOLD INDIVIDUALLY.

* Use Pilot Part# HG-PILOT2

- **Cut Faster**

- **Cut Cleaner**

- **Lasts Longer**

TUNGSTEN
CARBIDE TEETH

| Size | Steel (rpm) | Stainless Steel (rpm) |
|-------------------|-------------|-----------------------|
| 9/16" to 13/16" | 700-1000 | 300-700 |
| 7/8" to 1-3/16" | 500-800 | 200-450 |
| 1-1/4" to 1-9/16" | 300-600 | 175-315 |
| 1-5/8" to 2" | 200-500 | 120-225 |
| 2-1/16" to 2-3/8" | 200-400 | 95-195 |
| 2-7/16" to 3" | 150-300 | 80-150 |
| 3-1/16" to 5" | 100-200 | 60-120 |



1-3/8" Cutting Depth

T.C.T. Hole Cutter

| Part # | Size | Cut | Shank | List |
|--------|---------|--------|-------|----------|
| HM0011 | 9/16" | 1-3/8" | 1/2" | \$81.11 |
| HM0012 | 5/8" | 1-3/8" | 1/2" | \$81.11 |
| HM0013 | 11/16" | 1-3/8" | 1/2" | \$81.11 |
| HM0014 | 3/4" | 1-3/8" | 1/2" | \$81.11 |
| HM0015 | 13/16" | 1-3/8" | 1/2" | \$81.11 |
| HM0016 | 7/8" | 1-3/8" | 1/2" | \$81.11 |
| HM0017 | 15/16" | 1-3/8" | 1/2" | \$81.11 |
| HM0018 | 1" | 1-3/8" | 1/2" | \$81.11 |
| HM0119 | 1-1/16" | 1-3/8" | 1/2" | \$93.89 |
| HM0019 | 1-1/8" | 1-3/8" | 1/2" | \$93.89 |
| HM0020 | 1-3/16" | 1-3/8" | 1/2" | \$93.89 |
| HM0021 | 1-1/4" | 1-3/8" | 1/2" | \$110.00 |
| HM0023 | 1-3/8" | 1-3/8" | 1/2" | \$110.00 |
| HM0024 | 1-1/2" | 1-3/8" | 1/2" | \$127.78 |
| HM0025 | 1-5/8" | 1-3/8" | 1/2" | \$148.33 |
| HM0026 | 1-3/4" | 1-3/8" | 1/2" | \$148.33 |
| HM0027 | 1-7/8" | 1-3/8" | 1/2" | \$168.33 |
| HM0028 | 2" | 1-3/8" | 1/2" | \$188.33 |
| HM0029 | 2-1/8" | 1-3/8" | 1/2" | \$188.33 |
| HM0030 | 2-1/4" | 1-3/8" | 1/2" | \$213.89 |
| HM0032 | 2-3/8" | 1-3/8" | 1/2" | \$213.89 |
| HM0033 | 2-1/2" | 1-3/8" | 1/2" | \$252.22 |



- ◆ Excellent Wear and Heat Resistance
- ◆ Tungsten Carbide Teeth
- ◆ Cuts Stainless Steel and Tough Alloys
- ◆ Works in 1/2" Chucks
- ◆ Made In Taiwan

- Sheet Metal
- Steel Plate
- Stainless Steel
- Copper
- Cast Iron

**SHEET METAL
STEEL PLATE
STAINLESS STEEL**

**FOR USE IN 1/2"
CHUCK DRILLS**



T.C.T. HOLE CUTTERS ARE SOLD INDIVIDUALLY.

POW!



2" Cutting Depth

T.C.T. Steel Door Hole Cutter

| Part # | Size | Cut | Shank | List |
|--------|--------|-----|-------|----------|
| HP0014 | 3/4" | 2" | 1/2" | \$75.00 |
| HP0018 | 1" | 2" | 1/2" | \$75.00 |
| HP0021 | 1-1/4" | 2" | 1/2" | \$101.39 |
| HP0029 | 2-1/8" | 2" | 1/2" | \$172.92 |

- ◆ Made for Door Knob and Lock Installation
- ◆ Tungsten Carbide Teeth
- ◆ Works in 1/2" Chucks
- ◆ Made In Taiwan



Replacement Parts

| Part # | Description | List |
|-----------|-------------------------|---------|
| HF-PILOT | CENTER DRILL φ6mm x 50L | \$8.25 |
| HF-S | SPRING 1.2MM X 16L | \$0.75 |
| HG-PILOT | CENTER DRILL φ6mm x 60L | \$9.45 |
| HG-PILOT2 | CENTER DRILL φ8mm x 60L | \$9.45 |
| HG-S | SPRING 1.2MM X 23L | \$0.75 |
| HM-PILOT | CENTER DRILL φ6mm x 75L | \$11.11 |
| HM-S | SPRING 1.2MM X 50L | \$2.10 |
| HP-PILOT | CENTER DRILL φ6mm x 90L | \$12.50 |
| HP-S | SPRING 1.2MM X 60L | \$0.75 |



- ◆ Excellent Wear and Heat Resistance
- ◆ Tungsten Carbide Teeth
- ◆ Cuts Stainless Steel and Tough Alloys
- ◆ Works in 1/2" Chucks
- ◆ Made In Taiwan

- Sheet Metal
- Steel Plate
- Stainless Steel
- Copper
- Cast Iron



Roto Plate Cutter

| Part # | Size | X | OAL | Drilling | Shank | Qty. | List |
|----------|---------------|---|---------|----------|-------|------|----------|
| RPC-14 | 7/8" | X | 14-1/2" | 1-3/8" | 1/2" | 1 | \$143.92 |
| RPC-16 | 1" | X | 14-1/2" | 1-3/8" | 1/2" | 1 | \$143.92 |
| RPC-19 | 1-1/8" | X | 14-1/2" | 1-3/8" | 1/2" | 1 | \$161.81 |
| RPC-20 | 1-1/4" | X | 14-1/2" | 1-3/8" | 1/2" | 1 | \$184.36 |
| RPC-24 | 1-1/2" | X | 14-1/2" | 1-3/8" | 1/2" | 1 | \$201.78 |
| RPC-28 | 1-3/4" | X | 14-1/2" | 1-3/8" | 1/2" | 1 | \$229.53 |
| RPC-32 | 2" | X | 14-1/2" | 1-3/8" | 1/2" | 1 | \$283.53 |
| RPC-36 | 2-1/4" | X | 14-1/2" | 1-3/8" | 1/2" | 1 | \$318.03 |
| RPC-40 | 2-1/2" | X | 14-1/2" | 1-3/8" | 1/2" | 1 | \$356.08 |
| RPC-18EX | 18" Extension | | | | 1/2" | 1 | \$44.05 |

**SHEET METAL
STEEL PLATE
STAINLESS STEEL**

FOR USE IN 1/2"
CHUCK DRILLS

Reach the Impossible...



Bi-Metal Hole Saws - Variable Pitch

| Part # | Dia. Inches | Dia. MM | PIPE TAP SIZE | | PIPE ENT. SIZE | | Use | |
|-----------|-------------|---------|---------------|--------|----------------|--------|-------|----------|
| | | | Inches | MM | Inches | MM | Arbor | List |
| 275HW0011 | 9/16" | 14.3 | 3/8" | | | | * | \$14.58 |
| 275HW0012 | 5/8" | 15.5 | | | | | * | \$11.07 |
| 275HW0112 | 16mm | 16.0 | | | | | * | \$14.00 |
| 275HW0013 | 11/16" | 17.5 | | | | | * | \$11.07 |
| 275HW0014 | 3/4" | 19.0 | 1/2" | 13 mm | 3/8" | 10 mm | * | \$11.07 |
| 275HW0114 | 20mm | 20.0 | | | | | * | \$14.00 |
| 275HW0015 | 13/16" | 20.6 | | | | | * | \$11.07 |
| 275HW0016 | 7/8" | 22.2 | 3/4" | 19 mm | 1/2" | 13 mm | * | \$11.07 |
| 275HW0017 | 15/16" | 23.8 | | | | | * | \$11.07 |
| 275HW0117 | 25mm | 25.0 | | | | | * | \$14.85 |
| 275HW0018 | 1" | 25.4 | | | | | * | \$11.74 |
| 275HW0185 | 1-1/16" | 27.0 | | | | | * | \$11.74 |
| 275HW0019 | 1-1/8" | 28.8 | 1" | 25 mm | 3/4" | 19 mm | * | \$11.74 |
| 275HW0118 | 30mm | 30.0 | | | | | * | \$14.85 |
| 275HW0020 | 1-3/16" | 30.2 | | | | | * | \$11.74 |
| 275HW0021 | 1-1/4" | 31.8 | | | | | ** | \$11.74 |
| 275HW0121 | 32mm | 32.0 | | | | | ** | \$15.41 |
| 275HW0022 | 1-5/16" | 33.3 | | | | | ** | \$11.74 |
| 275HW0023 | 1-3/8" | 34.9 | | | 1" | 25 mm | ** | \$12.45 |
| 275HW0122 | 35mm | 35.0 | | | | | ** | \$17.01 |
| 275HW0123 | 1-7/16" | 36.5 | | | | | ** | \$12.45 |
| 275HW0024 | 1-1/2" | 38.1 | 1-1/4" | 32 mm | | | ** | \$12.69 |
| 275HW0124 | 1-9/16" | 39.7 | | | | | ** | \$12.69 |
| 275HW0224 | 40mm | 40.0 | | | | | ** | \$17.54 |
| 275HW0025 | 1-5/8" | 41.2 | | | | | ** | \$12.84 |
| 275HW0125 | 1-11/16" | 42.9 | | | | | ** | \$12.84 |
| 275HW0026 | 1-3/4" | 44.5 | 1-1/2" | 38 mm | 1-1/4" | 32 mm | ** | \$15.55 |
| 275HW0226 | 45mm | 45.0 | | | | | ** | \$21.25 |
| 275HW0126 | 1-13/16" | 46.0 | | | | | ** | \$15.55 |
| 275HW0027 | 1-7/8" | 47.6 | | | | | ** | \$15.78 |
| 275HW0127 | 50mm | 50.0 | | | | | ** | \$21.88 |
| 275HW0028 | 2" | 50.8 | | | 1-1/2" | 38 mm | ** | \$17.06 |
| 275HW0128 | 2-1/16" | 52.4 | | | | | ** | \$19.13 |
| 275HW0029 | 2-1/8" | 53.9 | | | | | ** | \$19.13 |
| 275HW0129 | 55mm | 55.0 | | | | | ** | \$26.14 |
| 275HW0030 | 2-1/4" | 57.2 | 2" | 51 mm | | | ** | \$19.28 |
| 275HW0031 | 2-5/16" | 58.7 | | | | | ** | \$19.45 |
| 275HW0032 | 2-3/8" | 60.3 | | | | | ** | \$19.55 |
| 275HW0033 | 2-1/2" | 63.5 | | | 2" | 51 mm | ** | \$20.62 |
| 275HW0034 | 2-9/16" | 65.1 | | | | | ** | \$20.74 |
| 275HW0134 | 2-5/8" | 66.7 | 2-1/2" | 64 mm | | | ** | \$21.22 |
| 275HW0234 | 68mm | 68.0 | | | | | ** | \$28.99 |
| 275HW0334 | 68.5mm | 68.5 | | | | | ** | \$28.99 |
| 275HW0135 | 2-3/4" | 69.9 | | | | | ** | \$21.22 |
| 275HW0136 | 2-7/8" | 73.0 | | | | | ** | \$21.22 |
| 275HW0236 | 75mm | 75.0 | | | | | ** | \$28.99 |
| 275HW0035 | 3" | 76.2 | | | 2-1/2" | 64 mm | ** | \$21.22 |
| 275HW0137 | 3-1/8" | 79.4 | | | | | ** | \$21.44 |
| 275HW0138 | 3-1/4" | 82.6 | 3" | 76 mm | | | ** | \$21.44 |
| 275HW0139 | 3-3/8" | 85.7 | | | | | ** | \$21.44 |
| 275HW0036 | 3-1/2" | 88.9 | | | | | ** | \$21.44 |
| 275HW0140 | 3-5/8" | 92.1 | | | 3" | 76 mm | ** | \$25.17 |
| 275HW0141 | 3-3/4" | 95.3 | 3-1/2" | 89 mm | | | ** | \$29.57 |
| 275HW0142 | 3-7/8" | 98.4 | | | | | ** | \$31.10 |
| 275HW0100 | 100mm | 100.0 | | | | | ** | \$38.79 |
| 275HW0037 | 4" | 101.6 | | | | | ** | \$32.44 |
| 275HW0143 | 4-1/8" | 104.8 | | | 3-1/2" | 89 mm | ** | \$35.49 |
| 275HW0144 | 4-1/4" | 108.0 | 4" | 102 mm | | | ** | \$46.19 |
| 275HW0038 | 4-1/2" | 114.3 | | | 4" | 102 mm | ** | \$63.89 |
| 275HW0145 | 4-3/4" | 120.7 | 4-1/2" | | | | ** | \$74.03 |
| 275HW0039 | 5" | 127.0 | | | | | ** | \$78.72 |
| 275HW0040 | 5-1/2" | 139.7 | | | | | ** | \$93.93 |
| 275HW0146 | 5-3/4" | 146.0 | | | | | ** | \$101.99 |
| 275HW0041 | 6" | 152.4 | | | | | ** | \$110.04 |



1 HOLE SAW PER BOX.
ARBOR NOT INCLUDED.

Made In



These High Quality Bi-Metal Hole Saws are made by a very special process. The cutting edge is electron beam welded to a tough alloy steel back. These hole saws are ideal for work where high performance & accuracy are needed. Saws have knock-out holes for easy core removal.

- ◆ Made In USA
- ◆ Bi-Metal Construction
- ◆ M3 Cutting Edge
- ◆ 5 Variable Pitch. Rc. 63-65
- ◆ Positive Rake
- ◆ 1-15/16" Cutting Depth
- ◆ Premium Quality
- ◆ Cuts Through 2" x 4"s
- ◆ Red Finish

- ➔ Wood
- ➔ Plastic
- ➔ Machinable Metal
- ➔ Nail Embedded Wood
- ➔ Plywood
- ➔ Pipes
- ➔ Light Gauge Stainless Steel

* USE ARBORS ARB-0, ARB-1 or ARB-2.
** USE ARBORS ARB-3, ARB-4 or ARB-5.



1 HOLE SAW PER BOX.
ARBOR NOT INCLUDED.

These High Quality Carbide Tipped Hole Saws are designed for use in abrasive materials such as particle board, fiberglass, cast iron, asbestos board, and formica. They are ideal for work where high performance & accuracy are needed. Saws have knock-out holes for easy core removal.

Made In



- ◆ Made In USA
- ◆ Tungsten Carbide Teeth
- ◆ Ground & Welded Set Teeth
- ◆ 3 Teeth Per Inch
- ◆ High Wear Resistance
- ◆ 1-1/2" Cutting Depth
- ◆ Premium Quality
- ◆ Black Finish

- Particle Board
- Fiberglass
- Cast Iron
- Asbestos Board
- Formica

* USE ARBORS ARB-0, ARB-1, ARB-2 or ARB-5.
** USE ARBORS ARB-3, ARB-4, ARB-5 or ARB-9.

Carbide Tipped Hole Saws

| Part # | Dia. | | PIPE TAP SIZE | | PIPE ENT. SIZE | | Use | |
|----------|----------|-------|---------------|--------|----------------|--------|-------|----------|
| | Inches | MM | Inches | MM | Inches | MM | Arbor | List |
| AT120034 | 3/4" | 19.0 | 1/2" | 13 mm | 3/8" | 10 mm | * | \$19.63 |
| AT131316 | 13/16" | 20.6 | | | | | * | \$19.99 |
| AT140078 | 7/8" | 22.2 | 3/4" | 19 mm | 1/2" | 13 mm | * | \$20.25 |
| AT151516 | 15/16" | 23.8 | | | | | * | \$20.95 |
| AT160001 | 1" | 25.4 | | | | | * | \$21.56 |
| AT171116 | 1-1/16" | 27.0 | | | | | * | \$22.33 |
| AT180118 | 1-1/8" | 28.8 | 1" | 25 mm | 3/4" | 19 mm | * | \$22.85 |
| AT191316 | 1-3/16" | 30.2 | | | | | * | \$23.67 |
| AT200114 | 1-1/4" | 31.8 | | | | | ** | \$23.79 |
| AT211516 | 1-5/16" | 33.3 | | | | | ** | \$23.79 |
| AT220138 | 1-3/8" | 34.9 | | | 1" | 25 mm | ** | \$24.19 |
| AT231716 | 1-7/16" | 36.5 | | | | | ** | \$24.25 |
| AT240112 | 1-1/2" | 38.1 | 1-1/4" | 32 mm | | | ** | \$24.76 |
| AT251916 | 1-9/16" | 39.7 | | | | | ** | \$25.69 |
| AT260158 | 1-5/8" | 41.2 | | | | | ** | \$26.26 |
| AT271116 | 1-11/16" | 42.9 | | | | | ** | \$27.50 |
| AT280134 | 1-3/4" | 44.5 | 1-1/2" | 38 mm | 1-1/4" | 32 mm | ** | \$27.50 |
| AT291316 | 1-13/16" | 46.0 | | | | | ** | \$28.08 |
| AT300178 | 1-7/8" | 47.6 | | | | | ** | \$28.65 |
| AT320002 | 2" | 50.8 | | | 1-1/2" | 38 mm | ** | \$29.52 |
| AT332116 | 2-1/16" | 52.4 | | | | | ** | \$34.15 |
| AT340218 | 2-1/8" | 53.9 | | | | | ** | \$34.74 |
| AT360214 | 2-1/4" | 57.2 | 2" | 51 mm | | | ** | \$35.93 |
| AT372516 | 2-5/16" | 58.7 | | | | | ** | \$36.62 |
| AT380238 | 2-3/8" | 60.3 | | | | | ** | \$37.14 |
| AT400212 | 2-1/2" | 63.5 | | | 2" | 51 mm | ** | \$38.80 |
| AT412916 | 2-9/16" | 65.1 | | | | | ** | \$39.10 |
| AT420258 | 2-5/8" | 66.7 | 2-1/2" | 64 mm | | | ** | \$40.08 |
| AT440234 | 2-3/4" | 69.9 | | | | | ** | \$41.28 |
| AT460278 | 2-7/8" | 73.0 | | | | | ** | \$42.54 |
| AT480003 | 3" | 76.2 | | | 2-1/2" | 64 mm | ** | \$43.75 |
| AT500318 | 3-1/8" | 79.4 | | | | | ** | \$52.73 |
| AT520314 | 3-1/4" | 82.6 | 3" | 76 mm | | | ** | \$53.64 |
| AT540338 | 3-3/8" | 85.7 | | | | | ** | \$57.01 |
| AT560312 | 3-1/2" | 88.9 | | | | | ** | \$58.21 |
| AT580358 | 3-5/8" | 92.1 | | | 3" | 76 mm | ** | \$59.41 |
| AT600334 | 3-3/4" | 95.3 | 3-1/2" | 89 mm | | | ** | \$61.08 |
| AT620378 | 3-7/8" | 98.4 | | | | | ** | \$61.83 |
| AT640004 | 4" | 101.6 | | | | | ** | \$64.93 |
| AT660418 | 4-1/8" | 104.8 | | | 3-1/2" | 89 mm | ** | \$90.13 |
| AT680414 | 4-1/4" | 108.0 | 4" | 102 mm | | | ** | \$93.39 |
| AT700438 | 4-3/8" | 111.0 | | | | | ** | \$94.56 |
| AT720412 | 4-1/2" | 114.3 | | | 4" | 102 mm | ** | \$95.07 |
| AT760434 | 4-3/4" | 120.7 | | | | | ** | \$103.52 |
| AT800005 | 5" | 127.0 | | | | | ** | \$106.57 |
| AT880512 | 5-1/2" | 139.7 | | | | | ** | \$112.23 |
| AT920534 | 5-3/4" | 146.0 | | | | | ** | \$114.99 |
| AT960006 | 6" | 152.4 | | | | | ** | \$118.05 |

CARBIDE TIPPED RPM CHART

| SIZE | ALUMINUM | PLASTIC | FIBER-GLASS | CERAMIC TILE | PARTICLE BOARD | CAST IRON | FORMICA |
|--------|----------|---------|-------------|--------------|----------------|-----------|---------|
| 3/4" | 1700 | 3430 | 250 | 500 | 3430 | 410 | 210 |
| 7/8" | 1500 | 2940 | 210 | 430 | 2940 | 350 | 180 |
| 1" | 1300 | 2570 | 190 | 370 | 2570 | 310 | 150 |
| 1-1/8" | 1100 | 2290 | 170 | 330 | 2290 | 270 | 140 |
| 1-3/8" | 900 | 1870 | 140 | 270 | 1870 | 220 | 110 |
| 1-1/2" | 900 | 1710 | 120 | 250 | 1710 | 210 | 100 |
| 1-3/4" | 700 | 1470 | 110 | 210 | 1470 | 180 | 90 |
| 2" | 600 | 1290 | 90 | 190 | 1290 | 150 | 80 |
| 2-1/4" | 600 | 1140 | 80 | 170 | 1140 | 140 | 70 |
| 2-1/2" | 500 | 1030 | 70 | 150 | 1030 | 120 | 60 |
| 3" | 400 | 860 | 60 | 120 | 860 | 100 | 50 |
| 3-1/4" | 400 | 790 | 60 | 110 | 790 | 90 | 50 |
| 3-5/8" | 400 | 710 | 50 | 100 | 710 | 90 | 40 |
| 3-3/4" | 300 | 690 | 50 | 100 | 690 | 80 | 40 |
| 4-1/8" | 300 | 620 | 50 | 90 | 620 | 70 | 40 |
| 4-3/4" | 300 | 540 | 40 | 80 | 540 | 60 | 30 |
| 5" | 200 | 480 | 40 | 80 | 500 | 60 | 30 |
| 5-1/2" | 200 | 420 | 40 | 70 | 460 | 50 | 30 |
| 6" | 100 | 360 | 30 | 60 | 420 | 40 | 30 |

Carbide Grit Hole Saws

| Part # | Dia. | | PIPE TAP SIZE | | PIPE ENT. SIZE | | Use | |
|--------|----------|-------|---------------|--------|----------------|--------|-------|----------|
| | Inches | MM | Inches | MM | Inches | MM | Arbor | List |
| CG0012 | 3/4" | 19.0 | 1/2" | 13 mm | 3/8" | 10 mm | * | \$41.81 |
| CG0013 | 13/16" | 20.6 | | | | | * | \$41.81 |
| CG0014 | 7/8" | 22.2 | 3/4" | 19 mm | 1/2" | 13 mm | * | \$41.81 |
| CG0015 | 15/16" | 23.8 | | | | | * | \$41.81 |
| CG0016 | 1" | 25.4 | | | | | * | \$45.66 |
| CG0017 | 1-1/16" | 27.0 | | | | | * | \$45.66 |
| CG0018 | 1-1/8" | 28.8 | 1" | 25 mm | 3/4" | 19 mm | * | \$45.66 |
| CG0019 | 1-3/16" | 30.2 | | | | | * | \$45.66 |
| CG0020 | 1-1/4" | 31.8 | | | | | ** | \$46.85 |
| CG0021 | 1-5/16" | 33.3 | | | | | ** | \$46.85 |
| CG0022 | 1-3/8" | 34.9 | | | 1" | 25 mm | ** | \$47.23 |
| CG0023 | 1-7/16" | 36.5 | | | | | ** | \$47.23 |
| CG0024 | 1-1/2" | 38.1 | 1-1/4" | 32 mm | | | ** | \$47.23 |
| CG0025 | 1-9/16" | 39.7 | | | | | ** | \$47.23 |
| CG0026 | 1-5/8" | 41.2 | | | | | ** | \$47.23 |
| CG0027 | 1-11/16" | 42.9 | | | | | ** | \$47.23 |
| CG0028 | 1-3/4" | 44.5 | 1-1/2" | 38 mm | 1-1/4" | 32 mm | ** | \$57.94 |
| CG0029 | 1-13/16" | 46.0 | | | | | ** | \$57.94 |
| CG0030 | 1-7/8" | 47.6 | | | | | ** | \$57.94 |
| CG0032 | 2" | 50.8 | | | 1-1/2" | 38 mm | ** | \$57.94 |
| CG0033 | 2-1/16" | 52.4 | | | | | ** | \$57.94 |
| CG0034 | 2-1/8" | 53.9 | | | | | ** | \$68.56 |
| CG0036 | 2-1/4" | 57.2 | 2" | 51 mm | | | ** | \$68.56 |
| CG0037 | 2-5/16" | 58.7 | | | | | ** | \$68.56 |
| CG0038 | 2-3/8" | 60.3 | | | | | ** | \$68.56 |
| CG0040 | 2-1/2" | 63.5 | | | 2" | 51 mm | ** | \$77.28 |
| CG0041 | 2-9/16" | 65.1 | | | | | ** | \$77.28 |
| CG0042 | 2-5/8" | 66.7 | 2-1/2" | 64 mm | | | ** | \$77.28 |
| CG0044 | 2-3/4" | 69.9 | | | | | ** | \$77.28 |
| CG0046 | 2-7/8" | 73.0 | | | | | ** | \$77.28 |
| CG0048 | 3" | 76.2 | | | 2-1/2" | 64 mm | ** | \$93.64 |
| CG0050 | 3-1/8" | 79.4 | | | | | ** | \$93.64 |
| CG0052 | 3-1/4" | 82.6 | 3" | 76 mm | | | ** | \$93.64 |
| CG0054 | 3-3/8" | 85.7 | | | | | ** | \$93.64 |
| CG0056 | 3-1/2" | 88.9 | | | | | ** | \$99.44 |
| CG0058 | 3-5/8" | 92.1 | | | 3" | 76 mm | ** | \$107.04 |
| CG0060 | 3-3/4" | 95.3 | 3-1/2" | 89 mm | | | ** | \$115.28 |
| CG0062 | 3-7/8" | 98.4 | | | | | ** | \$119.06 |
| CG0064 | 4" | 101.6 | | | | | ** | \$123.46 |
| CG0066 | 4-1/8" | 104.8 | | | 3-1/2" | 89 mm | ** | \$132.14 |
| CG0068 | 4-1/4" | 108.0 | 4" | 102 mm | | | ** | \$138.78 |
| CG0070 | 4-3/8" | 111.0 | | | | | ** | \$145.66 |
| CG0072 | 4-1/2" | 114.3 | | | 4" | 102 mm | ** | \$152.16 |
| CG0076 | 4-3/4" | 120.7 | | | | | ** | \$162.84 |
| CG0080 | 5" | 127.0 | | | | | ** | \$174.22 |
| CG0088 | 5-1/2" | 139.7 | | | | | ** | \$186.42 |
| CG0092 | 5-3/4" | 146.0 | | | | | ** | \$186.42 |
| CG0096 | 6" | 152.4 | | | | | ** | \$186.42 |



1 HOLE SAW PER BOX.
ARBOR NOT INCLUDED.

These High Quality Carbide Grit Hole Saws are designed for use in hard or abrasive materials such as ceramics, fiberglass, hard woods, cast iron, & composites. They are best suited for thin materials that would strip bi-metal or carbide teeth. Saws have knock-out holes for easy core removal. Use a carbide tipped pilot arbor when drilling into ceramics.

Made In



- ◆ Made In USA
- ◆ Tungsten Carbide Grit
- ◆ Bonded to Alloy Back
- ◆ Gulletted Edge
- ◆ Super Wear Resistance
- ◆ 1-3/8" Cutting Depth
- ◆ Premium Quality
- ◆ Black Finish

- Ceramics
- Fiberglass
- Cast Iron
- Hard Woods
- Composites



CARBIDE GRIT

RECESSED LIGHTING HOLE SAWS

| Part# | Size | List |
|--------|--------|----------|
| CG0104 | 6-3/8" | \$196.85 |
| CG0110 | 6-7/8" | \$196.85 |

* USE ARBORS ARB-0, ARB-1, ARB-2 or ARB-8.
** USE ARBORS ARB-3, ARB-4, ARB-5 or ARB-9.

1/4" Pilot Drills

- ◆ Industrial Quality
- ◆ High Speed Steel
- ◆ Designed For Arbors
- ◆ HSS Sold 10/ Pack
- ◆ Carbide Sold Individually



PART #
277PD0014
 1/4" HSS PILOT DRILL
 3 STEPS
 List \$2.51



PART #
277PD0016
 1/4" HSS PILOT DRILL
 3 FLATS
 List \$2.51



PART #
277PD0018
 1/4" HSS PILOT DRILL
 1 FLAT
 List \$2.75



PART #
277PD0020
 1/4" CARBIDE PILOT DRILL
 2-7/8" LONG 1 FLAT
 List \$6.80



PART #
277PD0022
 1/4" CARBIDE PILOT DRILL
 4" LONG 1 FLAT
 List \$7.14

Extension

PART #
EXT001

12" Arbor Extension

For 7/16" Hex Shank Arbors Only!!!

List
 \$23.15

PART #
EXT002

12" Arbor Extension

For 3/8" Hex Shank Arbors Only!!!

List
 \$23.15



3/8" Hex Shank

Arbor Adapter Nut

PART #
NUT001

Adapter Nut

Turns
 1/2"-20
 Thread
 To 5/8"-18
 Thread



List
 \$6.65

Adapter nut allows smaller arbors without pins to fit larger hole saws. Not recommended for use with hole saws larger than 2-1/2".

Will work with any of the following 1/2"-20 threaded arbors:

- ARB-0
- ARB-1
- ARB-2
- ARB-8

Arbors - With Pilot Drills

- ◆ High Quality
- ◆ Sold Individually in White Boxes
- ◆ Includes one 3-Flats HSS Pilot Drill

FOR USE WITH:

- Bi-Metal Hole Saws
- Carbide Tipped Hole Saws
- Carbide Grit Hole Saws

| | |
|---|--|
| <p>PART #</p> <p>ARB-0</p> <p>1/4" 3-FLAT SHANK ARBOR FOR HOLE SAWS 9/16" - 1-3/16"</p> <p>List \$11.14</p> |  <p>1/2"-20 Thread</p> |
|---|--|

| | |
|--|--|
| <p>PART #</p> <p>ARB-1</p> <p>1/4" HEX POWER SHANK ARBOR FOR HOLE SAWS 9/16" - 1-3/16"</p> <p>List \$12.50</p> |  <p>1/2"-20 Thread</p> |
|--|--|

| | |
|--|---|
| <p>PART #</p> <p>ARB-2</p> <p>3/8" HEX POWER SHANK ARBOR FOR HOLE SAWS 9/16" - 1-3/16"</p> <p>List \$15.95</p> |  <p>1/2"-20 Thread</p> <p>HSS PILOT 277PD0018</p> |
|--|---|

| | |
|--|---|
| <p>PART #</p> <p>ARB-3</p> <p>3/8" HEX POWER SHANK FOR HOLE SAWS 1-1/4" - 6"</p> <p>List \$15.95</p> |  <p>5/8"-18 Thread</p> <p>HSS PILOT 277PD0018</p> |
|--|---|

| | |
|--|--|
| <p>PART #</p> <p>ARB-4</p> <p>3/8" HEX POWER SHANK ARBOR FOR HOLE SAWS 1-1/4" - 6"</p> <p>List \$24.50</p> |  <p>5/8"-18 Thread</p> |
|--|--|

| | |
|---|---|
| <p>PART #</p> <p>ARB-5</p> <p>7/16" HEX POWER SHANK FOR HOLE SAWS 1-1/4" - 6"</p> <p>List \$24.50</p> |  <p>5/8"-18 Thread</p> <p>HSS PILOT 277PD0018</p> |
|---|---|

| | |
|---|---|
| <p>PART #</p> <p>ARB-8</p> <p>3/8" HEX POWER SHANK FOR HOLE SAWS 3/4" - 1-3/16"</p> <p>List \$27.79</p> |  <p>1/2"-20 Thread</p> <p>CARBIDE PILOT 277PD0020</p> |
|---|---|

| | |
|---|---|
| <p>PART #</p> <p>ARB-9</p> <p>7/16" HEX POWER SHANK FOR HOLE SAWS 1-1/4" - 6"</p> <p>List \$35.04</p> |  <p>5/8"-18 Thread</p> <p>CARBIDE PILOT 277PD0022</p> |
|---|---|



Use Arbors with Carbide Tipped Pilots when drilling with Carbide Tipped Hole Saws & Carbide Grit Hole Saws.



BI-METAL

**PART # 275AV02E
ELECTRICIAN'S HOLE SAW KIT**

8 Pc. Set contains:
1 each 7/8" - 1-1/8" - 1-3/8" - 1-3/4" - 2" - 2-1/2"
2 Arbors - ARB-2 - ARB-5

PRICE EACH \$131.73



BI-METAL

**PART # 275AV100
MAINTENANCE HOLE SAW KIT**

11 Pc. Set contains:
1 each 3/4" - 7/8" - 1-1/8" - 1-3/8" - 1-1/2"
1-3/4" - 2" - 2-1/4" - 2-1/2"
2 Arbors - ARB-2 - ARB-5

PRICE EACH \$182.75



**PART # 275AT100
CARBIDE TIPPED
MAINTENANCE HOLE SAW KIT**

11 Pc. Set contains:
1 each 3/4" - 7/8" - 1-1/8" - 1-3/8" - 1-1/2"
1-3/4" - 2" - 2-1/4" - 2-1/2"
2 Arbors - ARB-2 - ARB-5

PRICE EACH \$351.80



BI-METAL

**PART # 275AV08E
MASTER ELECTRICIAN'S HOLE
SAW KIT**

12 Pc. Set contains:
1 each 7/8" - 1-1/8" - 1-3/8" - 1-3/4" - 2" - 2-1/2"
3" - 3-5/8" - 4-1/8" - 4-1/2"
2 Arbors - ARB-2 - ARB-5

PRICE EACH \$275.35



BI-METAL

**PART # 275AV04P
PLUMBER'S HOLE SAW KIT**

8 Pc. Set contains:
1 each 3/4" - 7/8" - 1-1/8" - 1-1/2" - 1-3/4" -
2-1/4"
2 Arbors - ARB-2 - ARB-5

PRICE EACH \$129.39



**RECOMMENDED
Bi-Metal HOLE SAW
CUTTING SPEEDS IN RPM'S**



- ① **LUBRICANTS** - Use a good cutting oil for faster, more efficient cutting in ferrous metals. Cutting oil should not be used when cutting cast iron. Beeswax or paraffin is often used when cutting aluminum.
- ② **CUTTING POSITION** - Do not cut materials at an angle. All the hole saw teeth should be in contact with the material to avoid tooth damage.
- ③ **FEEDS** - For effective cutting, apply level and even pressure. Excessive pressure results in premature wear, dulling of the teeth, and breakage. When cutting material over 1" thick, the saw should be pulled back at intervals to allow chip clearance.

| SIZE | MILD STEEL | CAST IRON | TOOL & STAINLESS | BRASS | ALUMINUM |
|------------|------------|-----------|------------------|-------|----------|
| 9/16" | 580 | 400 | 300 | 790 | 900 |
| 5/8" | 550 | 365 | 275 | 730 | 825 |
| 11/16" | 500 | 330 | 250 | 665 | 750 |
| 3/4" | 460 | 300 | 230 | 600 | 690 |
| 13/16" | 425 | 280 | 210 | 560 | 635 |
| 7/8" | 390 | 260 | 195 | 520 | 585 |
| 15/16" | 370 | 245 | 185 | 495 | 555 |
| 1" | 350 | 235 | 175 | 470 | 525 |
| 1 - 1/16" | 325 | 215 | 160 | 435 | 480 |
| 1 - 1/8" | 300 | 200 | 150 | 400 | 450 |
| 1 - 3/16" | 285 | 190 | 145 | 380 | 425 |
| 1 - 1/4" | 275 | 180 | 140 | 360 | 410 |
| 1 - 5/16" | 260 | 175 | 135 | 345 | 390 |
| 1 - 3/8" | 250 | 165 | 125 | 330 | 375 |
| 1 - 7/16" | 240 | 160 | 120 | 315 | 360 |
| 1 - 1/2" | 230 | 150 | 115 | 300 | 345 |
| 1 - 9/16" | 220 | 145 | 110 | 290 | 330 |
| 1 - 5/8" | 210 | 140 | 105 | 280 | 315 |
| 1 - 11/16" | 205 | 135 | 100 | 270 | 305 |
| 1 - 3/4" | 195 | 130 | 95 | 260 | 295 |
| 1 - 13/16" | 190 | 125 | 95 | 250 | 285 |
| 1 - 7/8" | 180 | 120 | 90 | 240 | 270 |
| 2" | 170 | 115 | 85 | 230 | 255 |
| 2 - 1/16" | 165 | 110 | 80 | 220 | 245 |
| 2 - 1/8" | 160 | 105 | 80 | 210 | 240 |
| 2 - 1/4" | 150 | 100 | 75 | 200 | 225 |
| 2 - 5/16" | 145 | 100 | 75 | 195 | 225 |
| 2 - 3/8" | 140 | 95 | 70 | 190 | 220 |
| 2 - 1/2" | 135 | 90 | 65 | 180 | 205 |
| 2 - 9/16" | 130 | 85 | 65 | 175 | 200 |
| 2 - 5/8" | 130 | 85 | 65 | 170 | 195 |
| 2 - 3/4" | 125 | 80 | 60 | 160 | 185 |
| 2 - 7/8" | 120 | 80 | 60 | 160 | 180 |
| 3" | 115 | 75 | 55 | 150 | 170 |
| 3 - 1/8" | 110 | 70 | 55 | 140 | 165 |
| 3 - 1/4" | 105 | 70 | 50 | 140 | 155 |
| 3 - 3/8" | 100 | 65 | 50 | 130 | 150 |
| 3 - 1/2" | 95 | 65 | 45 | 130 | 145 |
| 3 - 5/8" | 95 | 60 | 45 | 120 | 140 |
| 3 - 3/4" | 90 | 60 | 45 | 120 | 135 |
| 3 - 7/8" | 90 | 60 | 45 | 120 | 135 |
| 4" | 85 | 55 | 40 | 110 | 130 |
| 4 - 1/8" | 80 | 55 | 40 | 110 | 120 |
| 4 - 1/4" | 80 | 55 | 40 | 110 | 120 |
| 4 - 1/2" | 75 | 50 | 35 | 100 | 105 |
| 4 - 3/4" | 75 | 50 | 35 | 95 | 95 |
| 5" | 65 | 45 | 30 | 90 | 90 |
| 5 - 1/2" | 60 | 40 | 25 | 85 | 85 |
| 5 - 3/4" | 55 | 35 | 25 | 75 | 75 |
| 6" | 55 | 35 | 25 | 75 | 75 |



All Purpose Reciprocating Blades - Bi-Metal

| Part # | Blade Length | Teeth Per Inch | Description | Width / Length | Pack QTY. | List/ea. | Bulk (50 Pcs.) Part # | List/ea. |
|-----------|--------------|----------------|------------------------|--------------------|-----------|----------|-----------------------|----------|
| RB636W | 6" | 6T | Wood & Nail Slope | 3/4" x 6" x .050" | 5 | \$3.64 | BU-RB636W | \$3.21 |
| RB656WS | 6" | 6T | Wood & Nail Scroll | 3/4" x 6" x .050" | 5 | \$3.68 | BU-RB656WS | \$3.35 |
| RB956W | 9" | 6T | Wood & Nail | 3/4" x 9" x .050" | 5 | \$5.10 | BU-RB956W | \$4.81 |
| RB125W | 12" | 6T | Wood & Nail | 3/4" x 12" x .050" | 5 | \$6.56 | BU-RB125W | \$6.27 |
| RB414M | 4" | 14T | Metal | 3/4" x 4" x .035" | 5 | \$2.10 | BU-RB414M | \$2.04 |
| RB418M | 4" | 18T | Metal | 3/4" x 4" x .035" | 5 | \$2.10 | BU-RB418M | \$2.04 |
| RB424M | 4" | 24T | Metal | 3/4" x 4" x .035" | 5 | \$2.10 | BU-RB424M | \$2.04 |
| RB610HDM | 6" | 10T | Metal | 3/4" x 6" x .035" | 5 | \$2.56 | BU-RB610HDM | \$2.48 |
| RB614HDM | 6" | 14T | Metal | 3/4" x 6" x .035" | 5 | \$2.56 | BU-RB614HDM | \$2.48 |
| RB618HDM | 6" | 18T | Metal | 3/4" x 6" x .035" | 5 | \$2.56 | BU-RB618HDM | \$2.48 |
| RB624HDM | 6" | 24T | Metal | 3/4" x 6" x .035" | 5 | \$2.56 | BU-RB624HDM | \$2.48 |
| RB810HDM | 8" | 10T | Metal 10/14 V.P. | 3/4" x 8" x .035" | 5 | \$4.08 | BU-RB810HDM | \$3.94 |
| RB814HDM | 8" | 14T | Metal | 3/4" x 8" x .035" | 5 | \$4.08 | BU-RB814HDM | \$3.94 |
| RB818HDM | 8" | 18T | Metal | 3/4" x 8" x .035" | 5 | \$4.08 | BU-RB818HDM | \$3.94 |
| RB1010HDM | 10" | 10T | Metal | 3/4" x 10" x .035" | 5 | \$5.78 | BU-RB1010HDM | \$5.54 |
| RB1018HDM | 10" | 18T | Metal | 3/4" x 10" x .035" | 5 | \$5.78 | BU-RB1018HDM | \$5.54 |
| RB1218HDM | 12" | 18T | Metal | 3/4" x 12" x .035" | 5 | \$6.56 | BU-RB1218HDM | \$6.27 |
| RB636DW | 6" | 6T | Drywall V Head | 3/4" x 6" x .050" | 5 | \$3.65 | BU-RB636DW | \$3.50 |
| R8CCRF | 8" | Carbide Grit | Cast Iron-Ceramic Tile | 3/4" x 8" x .050" | 1 | \$11.55 | BU-R8CCRF | \$10.21 |



Made In



- ◆ Made In USA
- ◆ 1/2" Universal Shank
- ◆ Milled Teeth
- ◆ Matrix II Cutting Edge
- ◆ Tooth Hardness Rc 65-67
- ◆ 8% Cobalt
- ◆ Vacuum Heat Treatment
- ◆ Long Life

- ◆ Shock Resistant Teeth
- ◆ High Edge Hardness
- ◆ High Heat Resistance
- ◆ High Wear Resistance
- ◆ Greater Rigidity
- ◆ Resists Tooth Strippage
- ◆ Accepts Higher Feed Pressure



Heavy Metal Reciprocating Blades - Bi-Metal



| Part # | Blade Length | Teeth Per Inch | Description | Width / Length | Pack QTY. | List/ea. | Bulk (50 Pcs.) Part # | List/ea. |
|--------|--------------|----------------|-------------|------------------|-----------|----------|-----------------------|----------|
| HM610 | 6" | 10T | Heavy Metal | 1" x 6" x .042" | 5 | \$4.29 | BU-HM610 | \$4.02 |
| HM614 | 6" | 14T | Heavy Metal | 1" x 6" x .042" | 5 | \$4.29 | BU-HM614 | \$4.02 |
| HM618 | 6" | 18T | Heavy Metal | 1" x 6" x .042" | 5 | \$4.29 | BU-HM618 | \$4.02 |
| HM910 | 9" | 10T | Heavy Metal | 1" x 9" x .042" | 5 | \$5.74 | BU-HM910 | \$5.47 |
| HM914 | 9" | 14T | Heavy Metal | 1" x 9" x .042" | 5 | \$5.74 | BU-HM914 | \$5.47 |
| HM918 | 9" | 18T | Heavy Metal | 1" x 9" x .042" | 5 | \$5.74 | BU-HM918 | \$5.47 |
| HM1214 | 12" | 14T | Heavy Metal | 1" x 12" x .042" | 5 | \$6.84 | BU-HM1214 | \$6.57 |
| HM1218 | 12" | 18T | Heavy Metal | 1" x 12" x .042" | 5 | \$6.84 | BU-HM1218 | \$6.57 |

Made In



- ◆ Made In USA
- ◆ 1/2" Universal Shank
- ◆ Milled Teeth
- ◆ Bi-Metal
- ◆ Tooth Hardness Rc 65-67
- ◆ 8% Cobalt
- ◆ 1" Width
- ◆ 0.42" Thick
- ◆ Smooth Cutting
- ◆ High Edge Hardness
- ◆ High Heat Resistance
- ◆ High Wear Resistance
- ◆ Greater Rigidity
- ◆ Resists Tooth Strippage
- ◆ Accepts Higher Feed Pressure





VIGOR™ Heavy Duty Reciprocating Blades - Bi-Metal

| Part # | Blade Length | Teeth Per Inch | Description | Width / Length | Pack QTY. | List/ea. | Bulk (50 Pcs.) Part # | List/ea. |
|-----------|--------------|----------------|-------------|--------------------|-----------|----------|-----------------------|----------|
| VIHD61014 | 6" | 10/14 V.P. | Heavy Duty | 3/4" x 6" x .050" | 5 | \$3.52 | BU-VIHD61014 | \$3.46 |
| VIHD81014 | 8" | 10/14 V.P. | Heavy Duty | 3/4" x 8" x .050" | 5 | \$4.76 | BU-VIHD81014 | \$4.70 |
| VIHD12014 | 12" | 10/14 V.P. | Heavy Duty | 3/4" x 12" x .050" | 5 | \$6.09 | BU-VIHD12014 | \$6.03 |

V.P. = Variable Pitch (Teeth)



VIGOR™ Demolition Reciprocating Blades - Bi-Metal

| Part # | Blade Length | Teeth Per Inch | Description | Width / Length | Pack QTY. | List/ea. | Bulk (25 Pcs.) Part # | List/ea. |
|-----------|--------------|----------------|-------------|--------------------|-----------|----------|-----------------------|----------|
| VIDM60006 | 6" | 6T | Demolition | 7/8" x 6" x .062" | 3 | \$6.57 | BU-VIDM60006 | \$6.50 |
| VIDM60010 | 6" | 10T | Demolition | 7/8" x 6" x .062" | 3 | \$6.57 | BU-VIDM60010 | \$6.50 |
| VIDM90006 | 9" | 6T | Demolition | 7/8" x 9" x .062" | 3 | \$8.32 | BU-VIDM90006 | \$8.26 |
| VIDM90010 | 9" | 10T | Demolition | 7/8" x 9" x .062" | 3 | \$8.32 | BU-VIDM90010 | \$8.26 |
| VIDM12006 | 12" | 6T | Demolition | 7/8" x 12" x .062" | 3 | \$11.01 | BU-VIDM12006 | \$10.95 |
| VIDM12010 | 12" | 10T | Demolition | 7/8" x 12" x .062" | 3 | \$11.01 | BU-VIDM12010 | \$10.95 |

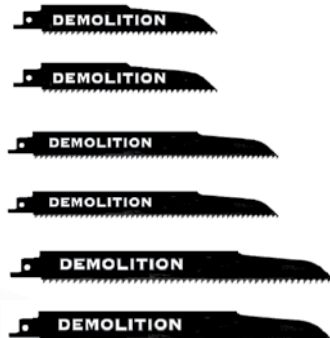

- ◆ Made In USA
- ◆ 1/2" Universal Shank
- ◆ 45% Thicker Than All Purpose Blades

- ◆ Wider Than All Purpose Blades
- ◆ Stay Rigid
- ◆ No Vibration
- ◆ More Cuts Per Blade

Tooth Style:





Retail Packs



All Purpose Reciprocating Blades - Bi-Metal

| Part # | Blade Length | Teeth Per Inch | Pack Description | Width / Length | QTY. | List/Pack |
|--------|--------------|----------------|-------------------|--------------------|------|-----------|
| W636 | 6" | 6T | Wood & Nail Slope | 3/4" x 6" x .050" | 5 | \$19.76 |
| W956 | 9" | 6T | Wood & Nail | 3/4" x 9" x .050" | 5 | \$27.67 |
| W125 | 12" | 6T | Wood & Nail | 3/4" x 12" x .050" | 5 | \$35.57 |
| M614 | 6" | 14T | Metal | 3/4" x 6" x .035" | 5 | \$14.82 |
| M618 | 6" | 18T | Metal | 3/4" x 6" x .035" | 5 | \$14.82 |
| M624 | 6" | 24T | Metal | 3/4" x 6" x .035" | 5 | \$14.82 |
| M810 | 8" | 10T | Metal | 3/4" x 8" x .035" | 5 | \$22.14 |
| M814 | 8" | 14T | Metal | 3/4" x 8" x .035" | 5 | \$22.14 |
| M818 | 8" | 18T | Metal | 3/4" x 8" x .035" | 5 | \$22.14 |
| M1218 | 12" | 18T | Metal | 3/4" x 12" x .035" | 5 | \$35.57 |

VIGOR™ Heavy Duty and Demolition - Bi-Metal

| Part # | Blade Length | Teeth Per Inch | Pack Description | Width / Length | QTY. | List/Pack |
|--------|--------------|----------------|------------------|--------------------|------|-----------|
| HD610 | 6" | 10/14T | Heavy Duty | 3/4" x 6" x .050" | 5 | \$18.22 |
| HD810 | 8" | 10/14T | Heavy Duty | 3/4" x 8" x .050" | 5 | \$24.64 |
| HD120 | 12" | 10/14T | Heavy Duty | 3/4" x 12" x .050" | 5 | \$31.54 |
| DM606 | 6" | 6T | Demolition | 7/8" x 6" x .062" | 3 | \$20.39 |
| DM610 | 6" | 10T | Demolition | 7/8" x 6" x .062" | 3 | \$20.39 |
| DM906 | 9" | 6T | Demolition | 7/8" x 9" x .062" | 3 | \$25.84 |
| DM910 | 9" | 10T | Demolition | 7/8" x 9" x .062" | 3 | \$25.84 |
| DM1206 | 12" | 6T | Demolition | 7/8" x 12" x .062" | 3 | \$34.19 |
| DM1210 | 12" | 10T | Demolition | 7/8" x 12" x .062" | 3 | \$34.19 |

- ◆ Made In USA
- ◆ Same Bi-Metal Blades p.59 & 61
- ◆ Slim-Line Retail Packs
- ◆ Price Per Pack

Made In



Rack
P. 66

Bulk Retail Packs



All Purpose Reciprocating Blades - Bi-Metal

| Part # | Blade Length | Teeth Per Inch | Pack Description | Width / Length | QTY. | List/Pack |
|---------|--------------|----------------|-------------------|--------------------|------|-----------|
| W636-B | 6" | 6T | Wood & Nail Slope | 3/4" x 6" x .050" | 50 | \$173.94 |
| W956-B | 9" | 6T | Wood & Nail | 3/4" x 9" x .050" | 50 | \$260.91 |
| W125-B | 12" | 6T | Wood & Nail | 3/4" x 12" x .050" | 50 | \$339.97 |
| M614-B | 6" | 14T | Metal | 3/4" x 6" x .035" | 50 | \$135.78 |
| M618-B | 6" | 18T | Metal | 3/4" x 6" x .035" | 50 | \$135.78 |
| M624-B | 6" | 24T | Metal | 3/4" x 6" x .035" | 50 | \$135.78 |
| M810-B | 8" | 10T | Metal | 3/4" x 8" x .035" | 50 | \$213.47 |
| M814-B | 8" | 14T | Metal | 3/4" x 8" x .035" | 50 | \$213.47 |
| M818-B | 8" | 18T | Metal | 3/4" x 8" x .035" | 50 | \$213.47 |
| M1218-B | 12" | 18T | Metal | 3/4" x 12" x .035" | 50 | \$339.97 |



VIGOR™ Heavy Duty and Demolition - Bi-Metal

| Part # | Blade Length | Teeth Per Inch | Pack Description | Width / Length | QTY. | List/Pack |
|----------|--------------|----------------|------------------|--------------------|------|-----------|
| HD610-B | 6" | 10/14T | Heavy Duty | 3/4" x 6" x .050" | 50 | \$178.84 |
| HD810-B | 8" | 10/14T | Heavy Duty | 3/4" x 8" x .050" | 50 | \$243.04 |
| HD120-B | 12" | 10/14T | Heavy Duty | 3/4" x 12" x .050" | 50 | \$312.03 |
| DM606-B | 6" | 6T | Demolition | 7/8" x 6" x .062" | 25 | \$168.21 |
| DM610-B | 6" | 10T | Demolition | 7/8" x 6" x .062" | 25 | \$168.21 |
| DM906-B | 9" | 6T | Demolition | 7/8" x 9" x .062" | 25 | \$213.65 |
| DM910-B | 9" | 10T | Demolition | 7/8" x 9" x .062" | 25 | \$213.65 |
| DM1206-B | 12" | 6T | Demolition | 7/8" x 12" x .062" | 25 | \$283.27 |
| DM1210-B | 12" | 10T | Demolition | 7/8" x 12" x .062" | 25 | \$283.27 |

- ◆ Made In USA
- ◆ Same Bi-Metal Blades p. 59 & 61
- ◆ Slim-Line Retail Packs
- ◆ Price Per Pack





Made In



- ◆ Made In U.S.A.
- ◆ Industrial Quality
- ◆ Milled Teeth

BOSCH Shank Metal Cutting Blades - Bi-Metal



| Part # | Blade Length | Teeth Per Inch | Description | Width / Length | Application | Pack QTY. | List/ea. | Bulk (50 Pcs.) Part # | List/ea. |
|-----------|--------------|----------------|---------------------|------------------------|---------------------|-----------|----------|-----------------------|----------|
| BJB30014M | 3" | 14T | Bosch Shank Jig Saw | 3" x 3/8" x 0.35" | THICK METAL | 5 | \$2.78 | BJB30014MB | \$2.71 |
| BJB30018M | 3" | 18T | Bosch Shank Jig Saw | 3" x 3/8" x 0.35" | METAL TUBING | 5 | \$2.78 | BJB30018MB | \$2.71 |
| BJB30024M | 3" | 24T | Bosch Shank Jig Saw | 3" x 3/8" x 0.35" | THIN METAL TUBING | 5 | \$2.78 | BJB30024MB | \$2.71 |
| BJB52521M | 5-1/4" | 21T | Bosch Shank Jig Saw | 5-1/4" x 5/16" x .042" | SOFT STEEL ALUMINUM | 5 | \$5.67 | BJB52521MB | \$5.60 |

BOSCH Shank Wood / Plastic Cutting Blades - Bi-Metal

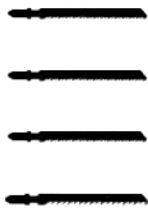

| Part # | Blade Length | Teeth Per Inch | Description | Width / Length | Application | Pack QTY. | List/ea. | Bulk (50 Pcs.) Part # | List/ea. |
|-----------|--------------|----------------|---------------------|------------------------|----------------------|-----------|----------|-----------------------|----------|
| BJB40006W | 4" | 6T | Bosch Shank Jig Saw | 4" x 5/16" x .040" | WOOD FIBER BOARD | 5 | \$3.38 | BJB40006WB | \$3.32 |
| BJB40008W | 4" | 8T | Bosch Shank Jig Saw | 4" x 5/16" x .035" | GENERAL WOOD/PLASTIC | 5 | \$3.38 | BJB40008WB | \$3.32 |
| BJB40010W | 4" | 10T | Bosch Shank Jig Saw | 4" x 5/16" x .035" | ALL WOOD/PLASTIC | 5 | \$3.38 | BJB40010WB | \$3.32 |
| BJB52512W | 5-1/4" | 12T | Bosch Shank Jig Saw | 5-1/4" x 5/16" x .042" | WOOD/PLASTIC METAL | 5 | \$5.67 | BJB52512WB | \$5.60 |

UNIVERSAL Shank Metal Cutting Blades - Bi-Metal



| Part # | Blade Length | Teeth Per Inch | Description | Width / Length | Application | Pack QTY. | List/ea. | Bulk (50 Pcs.) Part # | List/ea. |
|-----------|--------------|----------------|-------------------------------|------------------------|-------------------------------|-----------|----------|-----------------------|----------|
| UJB23418M | 2-3/4" | 18T | Universal Shank Jig Saw Blade | 2-3/4" x 3/16" x .035" | SCROLL METAL | 5 | \$2.44 | UJB23418MB | \$2.37 |
| UJB30018M | 3" | 18T | Universal Shank Jig Saw Blade | 3" x 3/8" x .035" | METAL 18 GAUGE & UNDER | 5 | \$2.31 | UJB30018MB | \$2.24 |
| UJB30024M | 3" | 24T | Universal Shank Jig Saw Blade | 3" x 3/8" x .035" | METAL 18 GAUGE & UNDER | 5 | \$2.31 | UJB30024MB | \$2.24 |
| UJB40014M | 4" | 14T | Universal Shank Jig Saw Blade | 4" x 3/8" x .035" | WOOD, RUBBER METAL UP TO 1/8" | 5 | \$2.61 | UJB40014MB | \$2.54 |

UNIVERSAL Shank Wood Cutting Blades - Bi-Metal



| Part # | Blade Length | Teeth Per Inch | Description | Width / Length | Application | Pack QTY. | List/ea. | Bulk (50 Pcs.) Part # | List/ea. |
|-----------|--------------|----------------|-------------------------------|-------------------|-----------------|-----------|----------|-----------------------|----------|
| UJB40006W | 4" | 6T | Universal Shank Jig Saw Blade | 4" x 3/8" x .035" | HARD WOOD BOARD | 5 | \$2.61 | UJB40006WB | \$2.54 |
| UJB40010W | 4" | 10T | Universal Shank Jig Saw Blade | 4" x 3/8" x .035" | HARD WOOD BOARD | 5 | \$2.61 | UJB40010WB | \$2.54 |



This High Tension Hack Saw Frame features a **NEW Cushin' Grip** handle and end pieces made of die cast aluminum. It is light weight yet extremely rigid and high tensioned; which provides cleaner, surer cuts. The blade can be set at a 55° angle for special flush cutting jobs (see figure A). The blade can also be inserted into the front end of the hack saw frame, and used as a versatile compass saw (see figure B). This frame fits most standard tool boxes.

- ◆ RED Cast Aluminum
- ◆ Light Weight
- ◆ Extremely Rigid
- ◆ Versatile
- ◆ 25,000 lbs Per Square Inch
- ◆ Includes 1 12" x 24T Bi-Metal Blade

High Tension Hack Saw Frame

| Part # | Description | List |
|-----------|-----------------------------|---------|
| 278HX0002 | High Tension Hack Saw Frame | \$26.05 |

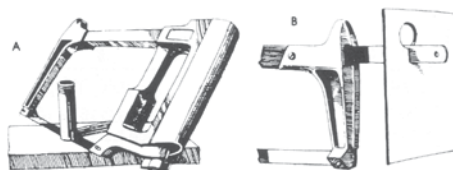

Hack Saw Blades - Bi-Metal

| Part # | OAL | Teeth Per Inch | Wide | Thick | QTY. | List/ea. |
|-----------|-----|----------------|------|-------|------|----------|
| 278BM0018 | 12" | 18T | 1/2" | .025" | 10 | \$2.20 |
| 278BM0024 | 12" | 24T | 1/2" | .025" | 10 | \$2.20 |
| 278BM0032 | 12" | 32T | 1/2" | .025" | 10 | \$2.20 |

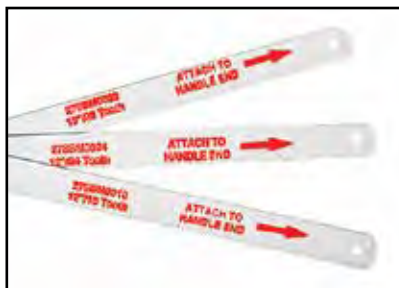

- ◆ Bi-Metal
- ◆ 8% Cobalt
- ◆ Premium Quality
- ◆ White Finish

Band Saw Blades - Bi-Metal

| Part # | OAL | Teeth Per Inch | Wide | Thick | QTY. | List/ea. |
|-----------|---------|----------------|------|-------|------|----------|
| 279SB0010 | 44-7/8" | 10T | 1/2" | .020" | 3 | \$11.50 |
| 279SB0014 | 44-7/8" | 14T | 1/2" | .020" | 3 | \$11.50 |
| 279SB0018 | 44-7/8" | 18T | 1/2" | .020" | 3 | \$11.50 |
| 279SB0024 | 44-7/8" | 24T | 1/2" | .020" | 3 | \$11.50 |
| 279VP1014 | 44-7/8" | 10/14 | 1/2" | .020" | 3 | \$11.50 |
| 279VP1418 | 44-7/8" | 14/18 | 1/2" | .020" | 3 | \$11.50 |



- Made In 
- ◆ Made In USA
 - ◆ Bi-Metal
 - ◆ 8% Cobalt
 - ◆ Premium Quality
 - ◆ Standard or Variable Pitch
 - ◆ Use In All Hand Held Band Saws



Made In



- ◆ Heavy Duty
- ◆ Red Oxide Finish

Reciprocating Blade Rack

| Part # | Rack | List |
|--------|------------|---------|
| RACK10 | Recip Rack | \$58.13 |

RACK10

3"Out X 8"H X 12"W

1/8" Metal Wire



Retail Packs
P. 62



RACK12

7"Out X 8"H X 24"W

1/4" Metal Wire

Made In



- ◆ Heavy Duty
- ◆ Black Oxide Finish

Metal Display Racks

| Part # | Rack | List |
|--------|--------------|----------|
| RACK12 | Top Header | \$81.38 |
| RACK18 | Bottom X-Tra | \$102.26 |

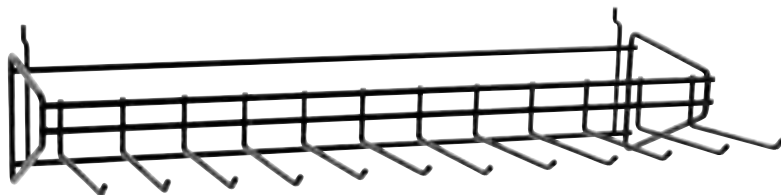

RACK18

15"Out X 8"H X 24"W

1/4" Metal Wire

All individually packed **ITM** drill bits have barcode and can be hung on this display. Simple and hassle free.



Electrician's Flex Bit With Screw Point - Stretch Bit

| Part # | Size | X | OAL | Shank | Application | List |
|-----------|------|---|-----|-------|--|---------|
| 308FB2438 | 3/8" | X | 24" | 3/16" | Popular with alarm & communication installers for pulling light wire. | \$38.63 |
| 308FB3638 | 3/8" | X | 36" | 3/16" | | \$40.66 |
| 308FB5438 | 3/8" | X | 54" | 3/16" | | \$45.18 |
| 308FB7238 | 3/8" | X | 72" | 3/16" | | \$50.32 |
| 308FB2412 | 1/2" | X | 24" | 3/16" | Popular with alarm & communication installers for pulling light wire. | \$43.82 |
| 308FB3612 | 1/2" | X | 36" | 3/16" | | \$47.95 |
| 308FB5412 | 1/2" | X | 54" | 3/16" | | \$48.69 |
| 308FB7212 | 1/2" | X | 72" | 3/16" | | \$53.27 |

- ◆ Screw Point
- ◆ Self Drilling
- ◆ Fish Hole On Each End
- ◆ Flexible Shaft

- Wood
- Studs
- Insulation



FISH HOLE ON SHANK



Stretch Bits are constructed of a high carbon steel self-feed auger bit, permanently brazed to a flexible shaft. This tool can be inserted through small wall openings enabling the operator to bore holes through studs within the wall cavities without damaging finished walls or ceilings.

Eye Holes are provided at each end of the Stretch Bits which allow easy retrieval of wires from either direction after drilling.

Steering Guide

| Part # | Description | Application | List |
|--------|----------------|--|---------|
| 308FBG | Steering Guide | Helps manipulate bits while within the wall cavity. | \$45.00 |



Circular Saw Blades

| Part # | Size | List |
|-----------|--------------|---------|
| DS-58-724 | 7-1/4" X 24T | \$12.49 |
| CS-58-824 | 8-1/4" X 24T | \$23.28 |
| CS-58-840 | 8-1/4" X 40T | \$34.73 |

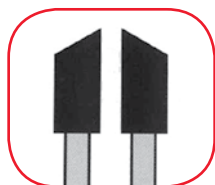

ALTERNATE TOP BEVELED TEETH

- ◆ Hard Body 38-42 Rc.
- ◆ K20 Tungsten Carbide Grade
- ◆ Individually Protected
- ◆ Individually Barcoded
- ◆ Imported

- ◆ Tungsten Carbide Tipped
- ◆ 5/8" Arbor With Diamond Knock Out
- ◆ 7000 RPM Maximum

- Wood Only



HSS Bell Hanger - Feeler Bits With Fish Hole (Electrical / Wire)

- ◆ Fish Hole In Flute For Pulling Wire
- ◆ Special Point For Fast Drilling In Wood & Metal
- ◆ Tapering For Quick Chip Clearance
- Telephone Installation
- Burglar Alarms
- Wire & Cable Applications

| Part # | Size | OAL | Shank | Qty. | List | Part # | Size | OAL | Shank | Qty. | List |
|-----------|-------|-----|-------|------|---------|-----------|-------|-----|-------|------|---------|
| 308BH1200 | 3/16" | 12" | 3/16" | 1 | \$10.80 | 308BH2403 | 3/8" | 24" | 3/8" | 1 | \$19.24 |
| 308BH1800 | 3/16" | 18" | 3/16" | 1 | \$11.50 | 308BH3003 | 3/8" | 30" | 3/8" | 1 | \$21.32 |
| 308BH1201 | 1/4" | 12" | 1/4" | 1 | \$11.34 | 308BH4203 | 3/8" | 42" | 3/8" | 1 | \$44.19 |
| 308BH1801 | 1/4" | 18" | 1/4" | 1 | \$12.50 | 308BH4803 | 3/8" | 48" | 3/8" | 1 | \$54.36 |
| 308BH2401 | 1/4" | 24" | 1/4" | 1 | \$15.60 | 308BH1806 | 7/16" | 18" | 3/8" | 1 | \$25.50 |
| 308BH3001 | 1/4" | 30" | 1/4" | 1 | \$18.93 | 308BH1204 | 1/2" | 12" | 3/8" | 1 | \$15.22 |
| 308BH4201 | 1/4" | 42" | 1/4" | 1 | \$38.86 | 308BH1804 | 1/2" | 18" | 3/8" | 1 | \$17.76 |
| 308BH1202 | 5/16" | 12" | 5/16" | 1 | \$12.55 | 308BH2404 | 1/2" | 24" | 3/8" | 1 | \$25.12 |
| 308BH1802 | 5/16" | 18" | 5/16" | 1 | \$14.05 | 308BH3004 | 1/2" | 30" | 3/8" | 1 | \$26.90 |
| 308BH2402 | 5/16" | 24" | 5/16" | 1 | \$18.68 | 308BH4204 | 1/2" | 42" | 3/8" | 1 | \$53.40 |
| 308BH1203 | 3/8" | 12" | 3/8" | 1 | \$13.42 | 308BH4804 | 1/2" | 48" | 3/8" | 1 | \$61.31 |
| 308BH1803 | 3/8" | 18" | 3/8" | 1 | \$15.31 | 308BH1858 | 5/8" | 18" | 1/2" | 1 | \$22.85 |
| | | | | | | 308BH1805 | 3/4" | 18" | 1/2" | 1 | \$24.90 |
| | | | | | | 308BH1810 | 1" | 18" | 1/2" | 1 | \$31.25 |



ALL BELL HANGER DRILL BITS ARE SOLD INDIVIDUALLY

CARBON STEEL Bell Hanger - Feeler Bits With Fish Hole

| Part # | Size | OAL | Shank | Qty. | List | Part # | Size | OAL | Shank | Qty. | List |
|-----------|------|-----|-------|------|--------|-----------|------|-----|-------|------|---------|
| 308CS1412 | 1/4" | 12" | 1/4" | 1 | \$5.45 | 308CS3818 | 3/8" | 18" | 3/8" | 1 | \$7.88 |
| 308CS1418 | 1/4" | 18" | 1/4" | 1 | \$6.42 | 308CS3824 | 3/8" | 24" | 3/8" | 1 | \$11.32 |
| 308CS1424 | 1/4" | 24" | 1/4" | 1 | \$9.05 | 308CS1804 | 1/2" | 18" | 3/8" | 1 | \$14.61 |

Less expensive than High Speed Steel (HSS) - Carbon Steel drills all wood, studs, aluminum, insulation, and drywall. Will not perform as well as HSS in steel.



Carbide Tip Bell Hanger - Feeler Bits With Fish Hole (Electrical / Wire)

- ◆ Fish Hole In Flute For Pulling Wire
- ◆ Special Point For Fast Drilling In Masonry & Wood
- Telephone Installation
- Burglar Alarms
- Wire & Cable Applications

| Part # | Size | OAL | Shank | Qty. | List | Part # | Size | OAL | Shank | Qty. | List |
|-----------|-------|-----|-------|------|---------|-----------|------|-----|-------|------|---------|
| 308CT1301 | 1/4" | 13" | 1/4" | 1 | \$11.94 | 308CT1304 | 1/2" | 13" | 3/8" | 1 | \$14.06 |
| 308CT1801 | 1/4" | 18" | 1/4" | 1 | \$13.01 | 308CT1804 | 1/2" | 18" | 3/8" | 1 | \$17.82 |
| 308CT2401 | 1/4" | 24" | 1/4" | 1 | \$15.31 | 308CT2404 | 1/2" | 24" | 3/8" | 1 | \$18.86 |
| 308CT1302 | 5/16" | 13" | 5/16" | 1 | \$12.87 | 308CT3004 | 1/2" | 30" | 3/8" | 1 | \$22.14 |
| 308CT1802 | 5/16" | 18" | 5/16" | 1 | \$14.31 | 308CT1305 | 3/4" | 13" | 1/2" | 1 | \$26.95 |
| 308CT2402 | 5/16" | 24" | 5/16" | 1 | \$15.31 | 308CT1805 | 3/4" | 18" | 1/2" | 1 | \$38.61 |
| 308CT1303 | 3/8" | 13" | 3/8" | 1 | \$13.33 | | | | | | |
| 308CT1803 | 3/8" | 18" | 3/8" | 1 | \$15.01 | | | | | | |
| 308CT2403 | 3/8" | 24" | 3/8" | 1 | \$16.19 | | | | | | |
| 308CT3003 | 3/8" | 30" | 3/8" | 1 | \$18.45 | | | | | | |
| 308CT3638 | 3/8" | 36" | 3/8" | 1 | \$22.38 | | | | | | |

12" Long Boy - HSS

| Part # | Size | Dec. | OAL | Flute | Qty. | List |
|-----------|--------|--------|-----|-------|------|----------|
| 216HS0864 | 1/8" | .1250 | 12" | 9" | 1 | \$12.37 |
| 216HS1264 | 3/16" | .1875 | 12" | 9" | 1 | \$12.72 |
| 216HS1464 | 7/32" | .2188 | 12" | 9" | 1 | \$16.20 |
| 216HS1664 | 1/4" | .2500 | 12" | 9" | 1 | \$14.98 |
| 216HS1864 | 9/32" | .2812 | 12" | 9" | 1 | \$17.33 |
| 216HS2064 | 5/16" | .3125 | 12" | 9" | 1 | \$21.47 |
| 216HS2464 | 3/8" | .3750 | 12" | 9" | 1 | \$24.76 |
| 216HS2864 | 7/16" | .4375 | 12" | 9" | 1 | \$46.46 |
| 216HS3264 | 1/2" | .5000 | 12" | 9" | 1 | \$46.87 |
| 216HS3664 | 9/16" | .5625 | 12" | 9" | 1 | \$74.00 |
| 216HS4064 | 5/8" | .6250 | 12" | 9" | 1 | \$86.04 |
| 216HS4464 | 11/16" | .6875 | 12" | 9" | 1 | \$110.94 |
| 216HS4864 | 3/4" | .7500 | 12" | 9" | 1 | \$122.97 |
| 216HS5264 | 13/16" | .8125 | 12" | 9" | 1 | \$139.76 |
| 216HS5664 | 7/8" | .8750 | 12" | 9" | 1 | \$159.60 |
| 216HS6064 | 15/16" | .9375 | 12" | 9" | 1 | \$178.49 |
| 216HS6464 | 1" | 1.000 | 12" | 9" | 1 | \$192.06 |
| 216HS7264 | 1-1/8" | 1.1250 | 12" | 9" | 1 | \$262.62 |

18" Long Boy - HSS

| Part # | Size | Dec. | OAL | Flute | Qty. | List |
|-----------|--------|-------|-----|-------|------|----------|
| 217HS1664 | 1/4" | .2500 | 18" | 14" | 1 | \$27.29 |
| 217HS2064 | 5/16" | .3125 | 18" | 14" | 1 | \$39.43 |
| 217HS2464 | 3/8" | .3750 | 18" | 14" | 1 | \$54.49 |
| 217HS3064 | 15/32" | .4688 | 18" | 14" | 1 | \$77.83 |
| 217HS3264 | 1/2" | .5000 | 18" | 14" | 1 | \$91.38 |
| 217HS4064 | 5/8" | .6250 | 18" | 14" | 1 | \$121.36 |
| 217HS4864 | 3/4" | .7500 | 18" | 14" | 1 | \$150.88 |



Brad Point Wood Drill

| Part # | Size | OAL | Shank | Qty. | List |
|-----------|-------|--------|-------|------|---------|
| 309BP0864 | 1/8" | 2-1/2" | 1/8" | 1 | \$2.33 |
| 309BP1064 | 5/32" | 3-1/8" | 5/32" | 1 | \$2.78 |
| 309BP1264 | 3/16" | 3-3/8" | 3/16" | 1 | \$3.17 |
| 309BP1664 | 1/4" | 4" | 1/4" | 1 | \$3.63 |
| 309BP2064 | 5/16" | 4-5/8" | 5/16" | 1 | \$3.89 |
| 309BP2464 | 3/8" | 4-7/8" | 3/8" | 1 | \$4.34 |
| 309BP2864 | 7/16" | 5-1/2" | 3/8" | 1 | \$6.09 |
| 309BP3264 | 1/2" | 6" | 3/8" | 1 | \$7.38 |
| 309BP4064 | 5/8" | 7" | 3/8" | 1 | \$10.79 |
| 309BP4864 | 3/4" | 7-3/4" | 3/8" | 1 | \$28.17 |
| 309BP5664 | 7/8" | 8-1/8" | 3/8" | 1 | \$37.12 |
| 309BP6464 | 1" | 8-1/2" | 3/8" | 1 | \$48.24 |



118° POINT

- ◆ M2 HSS
- ◆ Straight Shank To 1/2", Then Reduced
- ◆ Sharp Cutting Edge To Drill In Many Different Materials

- Mild Steel
- Aluminum
- Cast Iron
- Wood

- ⊙ Precision point angle for effective penetration through steel and wood.
- ⊙ Extra length flute with continuous cutting edges for drilling deep holes and fast chip removal.
- ⊙ Reduced shank fits all drill motors with 1/2" chucks.
- ⊙ Non-slip grips prevent the bit from spinning in the chuck.



Great For Acrylics!

- ◆ Precision Ground Flute
- ◆ Center Spur
- ◆ Two Shoulder Cutting Spurs
- ◆ Industrial Quality

- Wood
- Acrylics
- Polycarbonates



Part # 309BP0007
7 Pc. Set Woodworking
 1/8" - 3/16" - 1/4" - 5/16" - 3/8" -
 7/16" - 1/2"
List Price Each \$50.01



ALL SPADE POINT POWER DRILL BITS ARE SOLD INDIVIDUALLY. 1 PER POUCH.



Part # 300-ST-06

6 Pc. Spade Bit Set
3/8" - 1/2" - 5/8"
3/4" - 7/8" - 1"

List Price
Each \$21.26



WING TIP

- ◆ Cold Forged
- ◆ Full Length Treated
- ◆ Machine Finish
- ◆ Cutting Groove
- ◆ Rust Protection
- ◆ Wing Tip Design
- ◆ 1/4" Hex Power Groove Shank
- ◆ Individually Stamped With Size
- ◆ Industrial Quality

- Wood
- Drywall
- Plywood



IMPACT
1/4" HEX IMPACT SHANK

Quick Insert / Quick Spring Out Chuck Extensions. SOLD INDIVIDUALLY.



IMPACT
1/4" HEX IMPACT SHANK

- ◆ Quick-Change
- ◆ 1 PC. Construction
- ◆ 1/4" Hex Power Groove Shank
- ◆ Industrial Quality

6" Long Spade Wood Drill

| Part # | Size | OAL | Qty. | List |
|-----------|--------|-----|------|--------|
| 300SB1664 | 1/4" | 6" | 1 | \$3.44 |
| 300SB2064 | 5/16" | 6" | 1 | \$3.44 |
| 300SB2464 | 3/8" | 6" | 1 | \$3.44 |
| 300SB2864 | 7/16" | 6" | 1 | \$3.44 |
| 300SB3264 | 1/2" | 6" | 1 | \$3.44 |
| 300SB3664 | 9/16" | 6" | 1 | \$4.09 |
| 300SB4064 | 5/8" | 6" | 1 | \$4.09 |
| 300SB4464 | 11/16" | 6" | 1 | \$4.09 |
| 300SB4864 | 3/4" | 6" | 1 | \$4.09 |
| 300SB5264 | 13/16" | 6" | 1 | \$4.09 |
| 300SB5664 | 7/8" | 6" | 1 | \$4.25 |
| 300SB6064 | 15/16" | 6" | 1 | \$4.25 |
| 300SB6464 | 1" | 6" | 1 | \$4.25 |
| 300SB7264 | 1-1/8" | 6" | 1 | \$6.16 |
| 300SB8064 | 1-1/4" | 6" | 1 | \$6.16 |
| 300SB8864 | 1-3/8" | 6" | 1 | \$6.16 |
| 300SB9664 | 1-1/2" | 6" | 1 | \$6.16 |

16" Long Spade Wood Drill

| Part # | Size | OAL | Qty. | List |
|-----------|--------|-----|------|---------|
| 301SB1664 | 1/4" | 16" | 1 | \$8.93 |
| 301SB2464 | 3/8" | 16" | 1 | \$8.93 |
| 301SB3264 | 1/2" | 16" | 1 | \$8.93 |
| 301SB4064 | 5/8" | 16" | 1 | \$9.29 |
| 301SB4864 | 3/4" | 16" | 1 | \$9.29 |
| 301SB5664 | 7/8" | 16" | 1 | \$10.70 |
| 301SB6464 | 1" | 16" | 1 | \$11.76 |
| 301SB8864 | 1-3/8" | 16" | 1 | \$13.34 |



Extension - For Spade Bit

| Part # | Size | For Shank | Ø | List |
|---------|------------|-----------|------|---------|
| EXT-300 | 1/4" x 12" | 1/4" | 5/8" | \$14.18 |
| EXT-500 | 1/4" x 18" | 1/4" | 5/8" | \$16.28 |

1/4" Extensions - Drill Diameter Must Be Larger Than 5/8".



Self Feed (Multispur) Wood Drill

| Part # | Size | MM | Pipe Entrance | Tubing Entrance | Cutting Flute | Shank | List |
|----------|---------|-------|---------------|-----------------|---------------|-------|----------|
| 306ST-1 | 1" | 25.4 | 1/2" | 7/8" | 1" | 7/16" | \$40.25 |
| 306ST-2 | 1-1/8" | 28.6 | 1/2" | 1" | 1" | 7/16" | \$40.25 |
| 306ST-3 | 1-1/4" | 31.8 | 3/4" | 1-1/8" | 1" | 7/16" | \$40.25 |
| 306ST-4 | 1-3/8" | 34.9 | 1" | 1-1/4" | 1" | 7/16" | \$40.25 |
| 306ST-5 | 1-1/2" | 38.1 | 1" | 1-3/8" | 1" | 7/16" | \$40.25 |
| 306ST-6 | 1-3/4" | 44.5 | 1-1/4" | 1-1/2" | 1" | 7/16" | \$43.19 |
| 306ST-7 | 2" | 50.8 | 1-1/2" | 1-7/8" | 1" | 7/16" | \$46.14 |
| 306ST-8 | 2-1/8" | 54.0 | 1-1/2" | 2" | 1" | 7/16" | \$47.19 |
| 306ST-9 | 2-1/4" | 57.2 | 1-1/2" | 2-1/8" | 1" | 7/16" | \$51.19 |
| 306ST-10 | 2-9/16" | 65.1 | 2" | 2-1/2" | 1" | 7/16" | \$51.58 |
| 306ST-11 | 3" | 76.2 | 2-1/2" | 2-7/8" | 2" | 7/16" | \$132.94 |
| 306ST-12 | 3-5/8" | 92.1 | 3" | 3-1/2" | 2" | 7/16" | \$180.78 |
| 306ST-13 | 4-5/8" | 117.5 | 4" | 4-1/2" | 2" | 7/16" | \$212.75 |



- ◆ Fast Continuous and Self Feeding
- ◆ Deep Holes
- ◆ 7/16" Impact Hex Shank
- ◆ Double End Screw
- ◆ Extra Screw & Wrench
- ◆ Industrial Quality

- Wood
- Drywall
- Plywood
- Plumbing
- Rough-in Work

SELF FEED WOOD DRILLS ARE SOLD INDIVIDUALLY. 1 PER TUBE.

Replacement Screw Points

| Part # | Size | Fits | List |
|--------|------|-------------------|---------|
| SP0001 | 1/4" | 1-1/4" to 2-9/16" | \$6.75 |
| SP0002 | 1/4" | 3" to 4-5/8" | \$10.13 |

Screw Points come with replacement set screw and wrench.



Extensions for Ship Auger & Multispur

POWER BIT EXTENSIONS

| Part # | Size | For Shank | Ø | List | Part # | Size | For Shank | Ø | List |
|-----------|-------------|-----------|--------|---------|-----------|----------------|-----------|------|---------|
| 307BT5618 | 5/16" x 18" | 5/16" | 11/16" | \$24.79 | 307BT7609 | 7/16" x 9-1/2" | 7/16" | 7/8" | \$26.03 |
| | | | | | 307BT7612 | 7/16" x 12" | 7/16" | 7/8" | \$26.03 |
| | | | | | 307BT7618 | 7/16" x 18" | 7/16" | 7/8" | \$30.17 |
| | | | | | 307BT7624 | 7/16" x 24" | 7/16" | 7/8" | \$37.74 |

- ◆ HEX Wrench Included
- ◆ 2 Set Screws

5/16" Extensions - Drill Diameter Must Be Larger Than 11/16".
7/16" Extensions - Drill Diameter Must Be Larger Than 7/8".



Power Pole Auger Wood Drills

- ◆ Carbide Tipped
- ◆ Hex Shank
- ◆ Heat Treated
- ◆ Machine Ground
- ◆ Hollows
- ◆ Deep Throat
- ◆ Single Twist
- ◆ Single Cutter
- ◆ Side Lip
- ◆ Power Groove
- ◆ Self-Feeding Screw Point

- ➔ CCA Poles
- ➔ Creosoted Poles
- ➔ Railroad Ties
- ➔ Bulk Heads
- ➔ Heavy Timber

Made in Europe

ALL POWER POLE AUGER DRILL BITS ARE SOLD INDIVIDUALLY.

| Part # | Size | OAL | Drilling | Shank | List |
|-----------|--------|-----|----------|-------|----------|
| CPP-10716 | 7/16" | 18" | 15" | 7/16" | \$99.63 |
| CPP-11121 | 1/2" | 18" | 15" | 7/16" | \$90.30 |
| CPP-12122 | 1/2" | 24" | 21" | 7/16" | \$98.70 |
| CPP-13123 | 1/2" | 36" | 33" | 7/16" | \$191.10 |
| CPP-14911 | 9/16" | 18" | 15" | 7/16" | \$90.30 |
| CPP-15912 | 9/16" | 24" | 21" | 7/16" | \$98.70 |
| CPP-16913 | 9/16" | 36" | 33" | 7/16" | \$191.10 |
| CPP-17581 | 5/8" | 18" | 15" | 7/16" | \$90.30 |
| CPP-18582 | 5/8" | 24" | 21" | 7/16" | \$99.09 |
| CPP-19583 | 5/8" | 36" | 33" | 7/16" | \$191.10 |
| CPP-20161 | 11/16" | 18" | 15" | 7/16" | \$90.30 |
| CPP-21162 | 11/16" | 24" | 21" | 7/16" | \$98.80 |
| CPP-22163 | 11/16" | 36" | 33" | 7/16" | \$191.10 |
| CPP-23241 | 3/4" | 18" | 15" | 7/16" | \$102.90 |
| CPP-24342 | 3/4" | 24" | 21" | 7/16" | \$115.50 |
| CPP-25343 | 3/4" | 36" | 33" | 7/16" | \$212.10 |
| CPP-26131 | 13/16" | 18" | 15" | 7/16" | \$123.90 |
| CPP-27132 | 13/16" | 24" | 21" | 7/16" | \$144.90 |
| CPP-28133 | 13/16" | 36" | 33" | 7/16" | \$233.10 |
| CPP-29781 | 7/8" | 18" | 15" | 7/16" | \$157.50 |
| CPP-30782 | 7/8" | 24" | 21" | 7/16" | \$172.20 |
| CPP-31783 | 7/8" | 36" | 33" | 7/16" | \$304.50 |
| CPP-32561 | 15/16" | 18" | 15" | 7/16" | \$172.20 |
| CPP-33562 | 15/16" | 24" | 21" | 7/16" | \$195.30 |
| CPP-34563 | 15/16" | 36" | 33" | 7/16" | \$327.60 |
| CPP-35115 | 1" | 18" | 15" | 7/16" | \$182.70 |
| CPP-36121 | 1" | 24" | 21" | 7/16" | \$204.00 |
| CPP-37133 | 1" | 36" | 33" | 7/16" | \$336.00 |

Use with 1/2" Drills or Impact Wrenches:

- Stanley ID-04 "Yellow Jacket"
- Racine HIW-716
- Fairmount H8508

Also works well in heavy duty electric, pneumatic, and gas powered drills.



Power Pole Auger Drill Bits are carbide tipped wood drill bits that have a carbide-tipped cutting tip combined with a hardened steel cutting edge. These unique carbide tipped wood drill bits bore holes in all types of wood quickly, leaving little or no residue. A truly clean, smooth hole is produced. Power Pole carbide tipped wood auger drill bits require less torque to operate and can be used with electric, air, or gasoline powered drill motors and impact wrenches.

Made of premium steel, Power Pole Auger Bits are for boring CCA and Creosoted poles, railroad ties, bulkheads, and other heavy timber.



8" Long Ship Auger Wood Drill

| Part # | Size | Size In 16ths | OAL | Hex Shank | List |
|-----------|--------|---------------|-----|-----------|---------|
| 302SL3264 | 1/2" | 8 | 8" | 5/16" | \$27.82 |
| 302SL3664 | 9/16" | 9 | 8" | 5/16" | \$27.82 |
| 302SL4064 | 5/8" | 10 | 8" | 5/16" | \$27.82 |
| 302SL4464 | 11/16" | 11 | 8" | 5/16" | \$28.66 |
| 302SL4864 | 3/4" | 12 | 8" | 5/16" | \$29.53 |
| 302SL5264 | 13/16" | 13 | 8" | 5/16" | \$34.41 |
| 302SL5664 | 7/8" | 14 | 8" | 7/16" | \$35.55 |
| 302SL6064 | 15/16" | 15 | 8" | 7/16" | \$43.06 |
| 302SL6464 | 1" | 16 | 8" | 7/16" | \$43.95 |
| 302SL7264 | 1-1/8" | 18 | 8" | 7/16" | \$48.90 |
| 302SL8064 | 1-1/4" | 20 | 8" | 7/16" | \$56.65 |
| 302SL8864 | 1-3/8" | 22 | 8" | 7/16" | \$71.24 |
| 302SL9664 | 1-1/2" | 24 | 8" | 7/16" | \$73.90 |

- ◆ 6" Twist Length
- ◆ Heat Treated
- ◆ Machine Ground Hollows
- ◆ Deep Throat
- ◆ Single Twist
- ◆ Single Cutter
- ◆ Side Lip
- ◆ Self-Feeding Screw Point



- ➔ Bulk Heads
- ➔ General Timber

ALL SHIP AUGER DRILL BITS ARE SOLD INDIVIDUALLY.



18" Long Ship Auger Wood Drill

| Part # | Size | Size In 16ths | OAL | Hex Shank | List |
|-----------|--------|---------------|-----|-----------|---------|
| 303SL2464 | 3/8" | 6 | 18" | 5/16" | \$34.20 |
| 303SL2864 | 7/16" | 7 | 18" | 5/16" | \$34.20 |
| 303SL3264 | 1/2" | 8 | 18" | 5/16" | \$34.20 |
| 303SL3664 | 9/16" | 9 | 18" | 7/16" | \$34.20 |
| 303SL4064 | 5/8" | 10 | 18" | 7/16" | \$34.20 |
| 303SL4464 | 11/16" | 11 | 18" | 7/16" | \$37.57 |
| 303SL4864 | 3/4" | 12 | 18" | 7/16" | \$37.59 |
| 303SL5264 | 13/16" | 13 | 18" | 7/16" | \$41.76 |
| 303SL5664 | 7/8" | 14 | 18" | 7/16" | \$43.72 |
| 303SL6064 | 15/16" | 15 | 18" | 7/16" | \$47.81 |
| 303SL6464 | 1" | 16 | 18" | 7/16" | \$48.58 |
| 303SL7264 | 1-1/8" | 18 | 18" | 7/16" | \$57.46 |
| 303SL8064 | 1-1/4" | 20 | 18" | 7/16" | \$66.91 |
| 303SL8864 | 1-3/8" | 22 | 18" | 7/16" | \$74.54 |
| 303SL9664 | 1-1/2" | 24 | 18" | 7/16" | \$78.90 |

- ◆ 15" Twist Length
- ◆ Heat Treated
- ◆ Machine Ground Hollows
- ◆ Deep Throat
- ◆ Single Twist
- ◆ Single Cutter
- ◆ Side Lip
- ◆ Self-Feeding Screw Point



- ➔ Bulk Heads
- ➔ General Timber

ALL SHIP AUGER DRILL BITS ARE SOLD INDIVIDUALLY.



7" Sharpening File - Ship Augers

| Part # | Description | List |
|----------|--------------------|---------|
| 303SL-F1 | 7" Sharpening File | \$23.65 |

Files are specially designed to sharpen your valuable auger bits for a longer cutting life. These files feature one end single cut with safe edges (uncut) and one end safe (uncut) with single cut edges.

Made Of Premium Steel, Ship Auger Drills Are For Boring Bulkheads And General Timber.



Single Spur - Double Twist Wood Drill

- ◆ 8-1/2" Length
- ◆ 5-1/2" Twist Length
- ◆ Heat Treated
- ◆ Machine Ground Hollows
- ◆ Self-Feeding Screw Point
- ◆ Impact Hex Shank

ELECTRICIAN'S POWER BITS

These power bits are specifically designed to fit in between building studs for the installation of conduits and wires. Ideal use is with angle power drills.

Packaged with a rust protection sleeve. Sold Individually.

| Part # | Size | OAL | Shank | List |
|-----------|--------|--------|-------|---------|
| 304BU4064 | 5/8" | 8-1/2" | 5/16" | \$35.29 |
| 304BU4464 | 11/16" | 8-1/2" | 5/16" | \$37.57 |
| 304BU4864 | 3/4" | 8-1/2" | 5/16" | \$39.17 |
| 304BU5264 | 13/16" | 8-1/2" | 5/16" | \$43.82 |
| 304BU5664 | 7/8" | 8-1/2" | 5/16" | \$45.39 |
| 304BU6464 | 1" | 8-1/2" | 5/16" | \$54.01 |
| 304BU7264 | 1-1/8" | 8-1/2" | 7/16" | \$58.18 |
| 304BU8064 | 1-1/4" | 8-1/2" | 7/16" | \$65.95 |



Double Spur - Double Twist Wood Drill

- ◆ 6-1/2" Length
- ◆ 4" Twist Length
- ◆ Heat Treated
- ◆ Machine Ground Hollows
- ◆ Self-Feeding Screw Point
- ◆ Impact Hex Shank

PLUMBER POWER BITS

These power bits are specifically designed for boring holes where a smooth finish is required. Ideal for plumbing, heating, air conditioning, and other pipe installation.

Packaged with a rust protection sleeve. Sold Individually.

| Part # | Size | OAL | Shank | List |
|-----------|--------|--------|-------|---------|
| 305BU4864 | 3/4" | 6-1/2" | 7/16" | \$36.06 |
| 305BU5664 | 7/8" | 6-1/2" | 7/16" | \$43.08 |
| 305BU6464 | 1" | 6-1/2" | 7/16" | \$54.81 |
| 305BU7264 | 1-1/8" | 6-1/2" | 7/16" | \$58.22 |
| 305BU8064 | 1-1/4" | 6-1/2" | 7/16" | \$62.11 |
| 305BU8864 | 1-3/8" | 6-1/2" | 7/16" | \$80.89 |
| 305BU9664 | 1-1/2" | 6-1/2" | 7/16" | \$99.83 |



OSCILLATING MULTI-TOOL



Oscillating Blades - Wood / Metal

| Part # | Use For | Shank | Teeth | TPI | Width | Length | Box Qty. | List/ea. |
|-----------|----------------------|-----------|----------|-----|----------|---------|----------|----------|
| M-J35-10 | PRECISE WOOD | Multi | Japanese | 15 | 1-3/8" | 2-1/32" | 10 | \$15.69 |
| M-J35-25 | PRECISE WOOD | Multi | Japanese | 15 | 1-3/8" | 2-1/32" | 25 | \$14.94 |
| M-J35-100 | PRECISE WOOD | Multi | Japanese | 15 | 1-3/8" | 2-1/32" | 100 | \$14.23 |
| O-J35-10 | PRECISE WOOD | Open | Japanese | 15 | 1-3/8" | 2-1/32" | 10 | \$15.69 |
| O-J35-25 | PRECISE WOOD | Open | Japanese | 15 | 1-3/8" | 2-1/32" | 25 | \$14.94 |
| O-J35-100 | PRECISE WOOD | Open | Japanese | 15 | 1-3/8" | 2-1/32" | 100 | \$14.23 |
| O-M43-10 | METAL | Open | Bi-Metal | 18 | 1-11/16" | 2-1/2" | 10 | \$21.26 |
| O-M43-25 | METAL | Open | Bi-Metal | 18 | 1-11/16" | 2-1/2" | 25 | \$20.25 |
| O-M43-100 | METAL | Open | Bi-Metal | 18 | 1-11/16" | 2-1/2" | 100 | \$19.28 |
| O-S42-10 | WOOD AND NAIL | Open | Bi-Metal | 16 | 1-9/16" | 3-1/32" | 10 | \$21.06 |
| O-S42-25 | WOOD AND NAIL | Open | Bi-Metal | 16 | 1-9/16" | 3-1/32" | 25 | \$20.06 |
| O-S42-100 | WOOD AND NAIL | Open | Bi-Metal | 16 | 1-9/16" | 3-1/32" | 100 | \$19.10 |
| Q-J35-10 | PRECISE WOOD | Quick Fit | Japanese | 15 | 1-3/8" | 2-1/32" | 10 | \$18.07 |
| Q-J35-25 | PRECISE WOOD | Quick Fit | Japanese | 15 | 1-3/8" | 2-1/32" | 25 | \$17.21 |
| Q-J35-100 | PRECISE WOOD | Quick Fit | Japanese | 15 | 1-3/8" | 2-1/32" | 100 | \$16.39 |
| Q-M43-10 | METAL | Quick Fit | Bi-Metal | 18 | 1-11/16" | 2-1/2" | 10 | \$24.44 |
| Q-M43-25 | METAL | Quick Fit | Bi-Metal | 18 | 1-11/16" | 2-1/2" | 25 | \$23.28 |
| Q-M43-100 | METAL | Quick Fit | Bi-Metal | 18 | 1-11/16" | 2-1/2" | 100 | \$22.17 |
| Q-S42-10 | WOOD AND NAIL | Quick Fit | Bi-Metal | 16 | 1-9/16" | 3-1/32" | 10 | \$26.21 |
| Q-S42-25 | WOOD AND NAIL | Quick Fit | Bi-Metal | 16 | 1-9/16" | 3-1/32" | 25 | \$24.96 |
| Q-S42-100 | WOOD AND NAIL | Quick Fit | Bi-Metal | 16 | 1-9/16" | 3-1/32" | 100 | \$23.78 |



PRECISE WOOD
 → Wood
 → Drywall
 → Plywood

METAL
 → Nails → Aluminum
 → Metal → Copper
 → PVC → Drywall
 → Wood → Plywood

WOOD AND NAIL
 → Metal
 → Wood
 → Nails

- ◆ Use With Oscillating Multi-Tool
- ◆ Stainless Steel Attachment
- ◆ Deepest Plunge Depth
- ◆ Made in Switzerland



Drywall Cutter - HSS

| Part # | Size | OAL | Qty. | List |
|--------|-------|--------|------|---------|
| DW-316 | 3/16" | 3-1/4" | 1 | \$20.69 |



- ◆ Use With Rotary Tool
- ◆ M2 HSS
- Drywall
- Electrical Boxes
- Air Vents



ROTARY CUTOUT TOOL



ROTATION ONLY
Fast drilling speeds and lubricant are recommended when using these drills.



- ◆ Precision Design
- ◆ Special Carbide Head
- ◆ Carbide Insert Cuts



V GROOVE Tile Bit

| Part # | Size | X | OAL | Drilling | Shank | Qty. | List |
|----------|-------|---|-----|----------|-------|------|----------|
| VG-4001 | 1/8" | X | 3" | 2" | 1/8" | 1 | \$7.53 |
| VG-3002 | 3/16" | X | 3" | 2-3/4" | 3/16" | 1 | \$7.53 |
| VG-3002B | 3/16" | X | 3" | 2-3/4" | 3/16" | 25 | \$188.25 |
| VG-4002 | 3/16" | X | 4" | 2-3/4" | 3/16" | 1 | \$8.85 |
| VG-4002B | 3/16" | X | 4" | 2-3/4" | 3/16" | 25 | \$221.25 |
| VG-6001 | 3/16" | X | 6" | 4-1/4" | 3/16" | 1 | \$9.24 |
| VG-6001B | 3/16" | X | 6" | 4-1/4" | 3/16" | 25 | \$231.00 |
| VG-4003 | 1/4" | X | 4" | 2-3/4" | 1/4" | 1 | \$8.90 |
| VG-4003B | 1/4" | X | 4" | 2-3/4" | 1/4" | 25 | \$222.50 |
| VG-6002 | 1/4" | X | 6" | 4-1/4" | 1/4" | 1 | \$11.33 |
| VG-6002B | 1/4" | X | 6" | 4-1/4" | 1/4" | 25 | \$283.25 |
| VG-6003 | 5/16" | X | 6" | 4-1/4" | 5/16" | 1 | \$14.49 |
| VG-6003B | 5/16" | X | 6" | 4-1/4" | 5/16" | 25 | \$362.25 |
| VG-6004 | 3/8" | X | 6" | 4-1/4" | 3/8" | 1 | \$18.91 |
| VG-6005 | 1/2" | X | 6" | 4-1/4" | 1/2" | 1 | \$22.70 |



Blu Diamond Tile Bit

| Part # | Size | OAL | Shank | List |
|--------|-------|--------|-------|---------|
| BLU-1 | 1/4" | 2" | 3/8" | \$33.45 |
| BLU-3 | 5/16" | 2" | 3/8" | \$33.85 |
| BLU-4 | 3/8" | 2-1/2" | 3/8" | \$34.60 |
| BLU-5 | 1/2" | 2-1/2" | 3/8" | \$43.36 |
| BLU-6 | 3/4" | 2-3/4" | 3/8" | \$45.56 |
| BLU-8 | 1" | 2-3/4" | 3/8" | \$48.55 |

- ◆ Diamond Segments
- ◆ Wet Drilling
- ◆ Core Extraction
- ◆ Rotation Only

- Porcelain
- Ceramic
- Granite
- Marble



Glass Drills - STANDARD TIP

| Part # | Size | OAL | Shank | List |
|-----------|-------|--------|-------|---------|
| 601GL0864 | 1/8" | 2-1/4" | 1/8" | \$7.41 |
| 601GL1264 | 3/16" | 2-3/4" | 3/16" | \$8.54 |
| 601GL1664 | 1/4" | 3" | 1/4" | \$9.05 |
| 601GL2064 | 5/16" | 3-1/4" | 1/4" | \$10.05 |
| 601GL2464 | 3/8" | 3-1/2" | 3/8" | \$14.13 |
| 601GL3264 | 1/2" | 4" | 3/8" | \$20.10 |

ROTATION ONLY
Fast drilling speeds and lubricant are recommended when using these drills.



Glass Drills - QUAD-CUTTER

| Part # | Size | OAL | Shank | List |
|---------|-------|--------|-------|---------|
| QG-0012 | 3/16" | 2-3/4" | 3/16" | \$9.03 |
| QG-0014 | 1/4" | 3" | 1/4" | \$11.00 |
| QG-0016 | 5/16" | 3-1/4" | 1/4" | \$13.26 |
| QG-0018 | 3/8" | 3-1/2" | 3/8" | \$16.58 |
| QG-0020 | 1/2" | 4" | 3/8" | \$23.87 |

- ◆ Tungsten Carbide Tip

- Glass
- Mirrors
- Ceramics
- Tile
- Acrylics



Glass Drills - RAZOR CUTTER

| Part # | Size | OAL | Shank | List |
|----------|-------|-----|-------|---------|
| RAZ-4002 | 3/16" | 4" | 3/16" | \$9.33 |
| RAZ-4003 | 1/4" | 4" | 1/4" | \$10.11 |





ROTATION ONLY
Moderate drilling speeds and lubricant are recommended when using these drills.



Multi Purpose Drills - CARBIDE TIP

| Part # | Size | OAL | Drilling | Shank | List |
|-----------|-------|--------|----------|-------|---------|
| 600CD0864 | 1/8" | 3" | 1-1/2" | 1/8" | \$5.95 |
| 600CD1064 | 5/32" | 3-1/8" | 1-3/4" | 5/32" | \$6.42 |
| 600CD1264 | 3/16" | 3-1/2" | 2-3/16" | 3/16" | \$6.59 |
| 600CD1664 | 1/4" | 4-1/8" | 2-9/16" | 1/4" | \$7.23 |
| 600CD2064 | 5/16" | 4-3/4" | 3-5/32" | 5/16" | \$8.46 |
| 600CD2464 | 3/8" | 6" | 4-3/8" | 3/8" | \$9.74 |
| 600CD3264 | 1/2" | 6-3/4" | 4" | 1/2" | \$17.79 |
| 600CD4064 | 5/8" | 6" | 4" | 1/2" | \$23.33 |

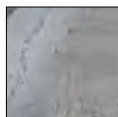

- ◆ Multi Purpose
- ◆ Tungsten Carbide
- ◆ Turbo Flute
- ◆ Heat Treated Body
- ◆ Polished Finish
- ◆ High Wearability
- ◆ Straight Shank
- ◆ ANSI Specification

- Brick
- Concrete
- Tile
- Marble
- Fiberglass
- Metal
- Wood

"THE PERFECT CARBIDE BIT FOR ANY FASTENING OR RENOVATION JOB!!!"

This drill bit is specially developed for efficient *rotary* drilling in a wide range of materials in one operation without changing the drill bit. Ideal for cordless machines and any fastening jobs where drilling in different materials is necessary.

ROTATION ONLY



Hard Steel Drill - Left Hand

| Part # | Size | X | OAL | Shank | List |
|--------|-------|---|-----|-------|---------|
| LHB-20 | 3/16" | X | 3" | 3/16" | \$13.80 |
| LHB-22 | 1/4" | X | 4" | 1/4" | \$15.31 |
| LHB-26 | 5/16" | X | 4" | 1/4" | \$16.59 |
| LHB-32 | 3/8" | X | 6" | 3/8" | \$19.71 |
| LHB-50 | 1/2" | X | 6" | 1/2" | \$34.79 |

Hard Steel Drill - Right Hand

| Part # | Size | X | OAL | Shank | List |
|--------|-------|---|-----|-------|---------|
| RHB-20 | 3/16" | X | 3" | 3/16" | \$11.32 |
| RHB-22 | 1/4" | X | 4" | 1/4" | \$12.84 |
| RHB-26 | 5/16" | X | 4" | 1/4" | \$13.98 |
| RHB-32 | 3/8" | X | 6" | 3/8" | \$15.49 |
| RHB-50 | 1/2" | X | 6" | 1/2" | \$30.20 |

- ◆ Carbide Tip
- ◆ Tempered Body
- ◆ ANSI B212.15-1994

- Broken Bolts
- Freeze Plugs
- Bearing Races
- Safes
- Shafts
- Gears
- Industrial Parts

Made In





Slow Spiral Masonry Drills

- ◆ General Purpose
- ◆ Tungsten Carbide
- ◆ Slow Spiral Flute
- ◆ Tempered Body
- ◆ Black Oxide Finish
- ◆ Gold Head
- ◆ Straight Shank
- ◆ ANSI Specification

- Brick
- Drywall
- Clay Pipe
- Tile
- Slate
- Cinder Block



Use with rotation or Percussion

A first generation carbide tipped drill bit, mass produced since the early 1970's, first in Europe, then in Puerto Rico, then in the USA. Still used ubiquitously and found in anchor kits all over the world.

| Part # | Size | X | OAL | Drilling | Shank | List |
|-----------|-------|---|-----|----------|-------|---------|
| 502SP4001 | 1/8" | X | 3" | 1-1/2" | 1/8" | \$1.35 |
| 502SP4002 | 3/16" | X | 4" | 2-1/2" | 3/16" | \$1.48 |
| 502SP6001 | 3/16" | X | 6" | 4" | 3/16" | \$2.66 |
| 502SP4732 | 7/32" | X | 4" | 2-1/2" | 7/32" | \$1.58 |
| 502SP4003 | 1/4" | X | 4" | 2-1/2" | 1/4" | \$1.61 |
| 502SP6002 | 1/4" | X | 6" | 4" | 1/4" | \$2.84 |
| 502SP1201 | 1/4" | X | 12" | 10" | 1/4" | \$6.26 |
| 502SP1814 | 1/4" | X | 18" | 16" | 1/4" | \$8.33 |
| 502SP4004 | 5/16" | X | 4" | 2-1/2" | 1/4" | \$1.98 |
| 502SP6003 | 5/16" | X | 6" | 4" | 1/4" | \$3.39 |
| 502SP1202 | 5/16" | X | 12" | 10" | 1/4" | \$7.10 |
| 502SP1856 | 5/16" | X | 18" | 16" | 5/16" | \$9.35 |
| 502SP4005 | 3/8" | X | 4" | 2-1/2" | 1/4" | \$2.65 |
| 502SP6004 | 3/8" | X | 6" | 4" | 3/8" | \$3.83 |
| 502SP1203 | 3/8" | X | 12" | 10" | 3/8" | \$8.41 |
| 502SP1838 | 3/8" | X | 18" | 16" | 3/8" | \$10.95 |
| 502SP2438 | 3/8" | X | 24" | 22" | 3/8" | \$14.65 |
| 502SP6005 | 7/16" | X | 6" | 4" | 1/4" | \$3.95 |
| 502SP4006 | 1/2" | X | 4" | 2-1/2" | 1/4" | \$3.95 |
| 502SP6007 | 1/2" | X | 6" | 4" | 3/8" | \$4.08 |
| 502SP1204 | 1/2" | X | 12" | 10" | 3/8" | \$9.43 |
| 502SP1812 | 1/2" | X | 18" | 16" | 3/8" | \$12.21 |
| 502SP6008 | 9/16" | X | 6" | 4" | 3/8" | \$6.55 |
| 502SP6009 | 5/8" | X | 6" | 4" | 3/8" | \$7.19 |
| 502SP1205 | 5/8" | X | 12" | 10" | 3/8" | \$13.33 |
| 502SP1858 | 5/8" | X | 18" | 16" | 3/8" | \$16.99 |
| 502SP6010 | 3/4" | X | 6" | 4" | 1/2" | \$9.34 |
| 502SP1206 | 3/4" | X | 12" | 10" | 1/2" | \$16.85 |
| 502SP1834 | 3/4" | X | 18" | 16" | 1/2" | \$21.71 |
| 502SP6011 | 7/8" | X | 6" | 4" | 1/2" | \$10.92 |
| 502SP1207 | 7/8" | X | 12" | 10" | 1/2" | \$18.94 |
| 502SP1878 | 7/8" | X | 18" | 16" | 1/2" | \$23.87 |
| 502SP6012 | 1" | X | 6" | 4" | 1/2" | \$14.47 |
| 502SP1208 | 1" | X | 12" | 10" | 1/2" | \$21.35 |
| 502SP1801 | 1" | X | 18" | 16" | 1/2" | \$28.69 |



Made For Hammer Drills!

Roto Percussion Drills - Super Shlager

| Part # | Size | X | OAL | Drilling | Shank | List |
|-----------|-------|---|--------|----------|----------|---------|
| 700040864 | 1/8" | X | 3" | 1-1/2" | 1/8" | \$4.03 |
| 700061064 | 5/32" | X | 6" | 4" | 5/32" | \$5.13 |
| 700041264 | 3/16" | X | 3-1/2" | 1-3/4" | 3/16" | \$4.28 |
| 700061264 | 3/16" | X | 6" | 4" | 3/16" | \$4.50 |
| 700061464 | 7/32" | X | 6" | 4" | 7/32" | \$5.93 |
| 700041664 | 1/4" | X | 4" | 2-1/2" | 1/4" | \$4.28 |
| 700061664 | 1/4" | X | 6" | 4" | 1/4" | \$5.17 |
| 700081664 | 1/4" | X | 12" | 10" | 1/4" | \$11.73 |
| 700024166 | 1/4" | X | 24" | 20" | 1/4" | \$23.28 |
| 700041864 | 9/32" | X | 4" | 2-1/2" | 1/4" | \$5.07 |
| 700042064 | 5/16" | X | 4-3/4" | 3-1/2" | 5/16" | \$5.32 |
| 700062064 | 5/16" | X | 6" | 4" | 5/16" | \$7.33 |
| 700062464 | 3/8" | X | 6" | 4" | 3/8" | \$6.67 |
| 700082464 | 3/8" | X | 12" | 10" | 3/8" | \$13.57 |
| 700020246 | 3/8" | X | 20" | 16" | 3/8" | \$21.27 |
| 700024246 | 3/8" | X | 24" | 20" | 3/8" | \$26.40 |
| 700062864 | 7/16" | X | 6" | 4" | 3/8" | \$10.94 |
| 700063264 | 1/2" | X | 6" | 4" | 3/8" | \$10.57 |
| 700083264 | 1/2" | X | 12" | 10" | 3/8" | \$19.74 |
| 700020326 | 1/2" | X | 20" | 16" | 3/8" | \$25.42 |
| 700024326 | 1/2" | X | 24" | 20" | 3/8" | \$30.43 |
| 700063664 | 9/16" | X | 6" | 4" | Hex 3/8" | \$15.22 |
| 700064064 | 5/8" | X | 6" | 4" | Hex 3/8" | \$15.95 |
| 700084064 | 5/8" | X | 12" | 10" | Hex 3/8" | \$25.18 |
| 700024406 | 5/8" | X | 24" | 20" | Hex 1/2" | \$34.22 |
| 700064864 | 3/4" | X | 6" | 4" | Hex 1/2" | \$20.35 |
| 700084864 | 3/4" | X | 12" | 10" | Hex 1/2" | \$28.97 |
| 700065664 | 7/8" | X | 6" | 4" | Hex 1/2" | \$24.20 |
| 700085664 | 7/8" | X | 12" | 10" | Hex 1/2" | \$39.72 |
| 700066464 | 1" | X | 6" | 4" | Hex 1/2" | \$28.60 |
| 700086464 | 1" | X | 12" | 10" | Hex 1/2" | \$45.77 |
| 700024646 | 1" | X | 24" | 20" | Hex 1/2" | \$80.18 |

- ◆ Heavy Duty
- ◆ Percussion Grade Tungsten Carbide
- ◆ Unique Spiral Flute for Fast Dust Removal
- ◆ Heat Treated Body
- ◆ Polished Finish
- ◆ Hex Shank on Larger Diameters to Prevent Slipping
- ◆ ANSI Specification

- Brick
- Cinder Block
- Up To 3000 psi Concrete
- Granite



SOLD INDIVIDUALLY.
1 PER TUBE.



These Drill Bits are made for machines with percussion. They will not perform with rotation only.

SDS-PLUS ROTARY HAMMER DRILLS



Chisel Shaped Head Geometry - Fast Penetration
High Volume Flute - Fast Dust Removal



REDLINE P. 81

- ◆ ANSI Specification
- ◆ Made in Germany

- Mild Concrete
- Brick
- Stone
- Masonry
- Aggregates



Serrated Head Geometry and Self Centering Tip - Easy Spot Drilling
Web Shaped Head - Improved Dust Release to Flute.
High Volume Flute - Faster Debris Removal
Flute Core Reinforcement - Reduces Vibrations
Rebar Chamfers - Prevents Carbide From Cracking When in Contact with Rebar



BOHR HAMMER P. 82-85

- ◆ ANSI Specification
- ◆ Made in Germany

- Concrete
- Brick
- Stone
- Masonry
- Aggregates



4 x 90° X-Cutter Carbide Head - Crushes Through and Prevents Sticking in Rebar
Wear Mark Indicator - Ensures Dimensional Hole Accuracy
Rebar Chamfers - Prevents Carbide From Cracking When in Contact With Rebar
More Carbide Mass - Extra Carbide Compared to Bohr Hammer
Flute Core Reinforcement - Reduces Vibrations



X-CUTTER P.86

- ◆ ANSI Specification
- ◆ Made in Germany

- Reinforced Concrete
- Brick
- Stone
- Masonry
- Aggregates



4 x 90° Serrated Tip Carbide Head - Crushes Through and Prevents Sticking in Rebar
High Helix Geometry Flute - For Torsional Stress and Getting Debris to Flute
Rebar Chamfers - Prevents Carbide From Cracking When in Contact With Rebar
4 Fluted Geometry - Evenly Distributes Flute Load for Less Flute Wear
Maximum Core Reinforcement - Reduces Vibrations



eVolution P. 87

- ◆ ANSI Specification
- ◆ Made in Germany

- Reinforced Concrete
- Brick
- Stone
- Masonry
- Aggregates

REDLINE

SDS-PLUS Rotary Hammer Drills

| Part # | Size | X | OAL | Drilling | Qty. | List |
|------------|-------|---|---------|----------|------|----------|
| RL-41064 | 5/32" | X | 4-1/4" | 2" | 1 | \$3.99 |
| RL-61064 | 5/32" | X | 6-1/4" | 4" | 1 | \$4.64 |
| RL-61064-B | 5/32" | X | 6-1/4" | 4" | 25 | \$108.10 |
| RL-41264 | 3/16" | X | 4-1/4" | 2" | 1 | \$3.41 |
| RL-61264 | 3/16" | X | 6-1/4" | 4" | 1 | \$4.52 |
| RL-61264-B | 3/16" | X | 6-1/4" | 4" | 25 | \$105.23 |
| RL-81264 | 3/16" | X | 8-1/4" | 6" | 1 | \$6.29 |
| RL-81264-B | 3/16" | X | 8-1/4" | 6" | 25 | \$148.47 |
| RL-41664 | 1/4" | X | 4-1/4" | 2" | 1 | \$3.34 |
| RL-41664-B | 1/4" | X | 4-1/4" | 2" | 25 | \$76.48 |
| RL-61664 | 1/4" | X | 6-1/4" | 4" | 1 | \$3.99 |
| RL-61664-B | 1/4" | X | 6-1/4" | 4" | 25 | \$91.81 |
| RL-81664 | 1/4" | X | 8-1/4" | 6" | 1 | \$5.52 |
| RL-81664-B | 1/4" | X | 8-1/4" | 6" | 25 | \$129.57 |
| RL-62064 | 5/16" | X | 6-1/4" | 4" | 1 | \$4.37 |
| RL-62064-B | 5/16" | X | 6-1/4" | 4" | 25 | \$102.35 |
| RL-62464 | 3/8" | X | 6-1/4" | 4" | 1 | \$4.79 |
| RL-62464-B | 3/8" | X | 6-1/4" | 4" | 25 | \$111.94 |
| RL-12038 | 3/8" | X | 12-1/4" | 10" | 1 | \$9.58 |
| RL-12038-B | 3/8" | X | 12-1/4" | 10" | 20 | \$187.46 |
| RL-63264 | 1/2" | X | 6-1/4" | 4" | 1 | \$6.25 |
| RL-63264-B | 1/2" | X | 6-1/4" | 4" | 25 | \$149.12 |
| RL-12012 | 1/2" | X | 12-1/4" | 10" | 1 | \$11.00 |
| RL-12012-B | 1/2" | X | 12-1/4" | 10" | 10 | \$107.53 |
| RL-63664 | 9/16" | X | 6-1/4" | 4" | 1 | \$9.58 |
| RL-84064 | 5/8" | X | 8-1/4" | 6" | 1 | \$13.30 |
| RL-84064-B | 5/8" | X | 8-1/4" | 6" | 10 | \$129.18 |
| RL-12058 | 5/8" | X | 12" | 10" | 1 | \$17.90 |
| RL-84864 | 3/4" | X | 8" | 6" | 1 | \$19.05 |
| RL-84864-B | 3/4" | X | 8" | 6" | 10 | \$188.60 |
| RL-12034 | 3/4" | X | 12" | 10" | 1 | \$24.46 |
| RL-12034-B | 3/4" | X | 12" | 10" | 5 | \$121.90 |
| RL-85664 | 7/8" | X | 8" | 6" | 1 | \$28.25 |
| RL-85664-B | 7/8" | X | 8" | 6" | 5 | \$140.68 |
| RL-12078 | 7/8" | X | 12" | 10" | 1 | \$32.12 |
| RL-12078-B | 7/8" | X | 12" | 10" | 5 | \$160.62 |
| RL-10001 | 1" | X | 10" | 8" | 1 | \$36.23 |
| RL-10001-B | 1" | X | 10" | 8" | 5 | \$181.13 |



For General Purpose Hammer Drilling In soft / medium / hard aggregates.

- ◆ Rotary Hammer Drill
- ◆ ANSI Specification
- ◆ Made in GERMANY

- ➔ Mild Concrete
- ➔ Brick
- ➔ Stone
- ➔ Masonry
- ➔ Aggregates



GERMANY

ANSI



This German Made Hammer Drill is a return to the original flute design of the 1970's. It's easier to make with today's high-tech fabrication machines and costs less. A very good drill for light to medium aggregates. Competes perfectly with Asian imports.

BOHR HAMMER

SDS-PLUS Rotary Hammer Drills

- ◆ Rotary Hammer Drill
- ◆ Serrated Head Geometry
- ◆ Self Centering Chisel Point
- ◆ ANSI Specification
- ◆ Special Tungsten Carbide Tip
- ◆ Copper / Silver Brazing
- ◆ Fastest Dust Removal
- ◆ Fastest Drilling Speeds
- ◆ Clean Round Holes
- ◆ Less Vibration
- ◆ Polished Finish
- ◆ Industrial Quality

- Concrete
- Brick
- Stone
- Masonry
- Aggregates



SOLD INDIVIDUALLY.
1 PER CLIP.

715Sxxxxx-B
Bulk Pack/Tube

| Part # | Size | X | OAL | Drilling | Head | Qty. | List |
|-------------|-------|---|---------|----------|--------|------|----------|
| 715S41064 | 5/32" | X | 4-1/4" | 2" | 4-PLUS | 1 | \$5.97 |
| 715S61064 | 5/32" | X | 6-1/4" | 4" | 4-PLUS | 1 | \$6.81 |
| 715S61064-B | 5/32" | X | 6-1/4" | 4" | 4-PLUS | 25 | \$161.74 |
| 715S41264 | 3/16" | X | 4-1/2" | 2" | 4-PLUS | 1 | \$5.97 |
| 715S41264-B | 3/16" | X | 4-1/2" | 2" | 4-PLUS | 25 | \$141.79 |
| 715S61264 | 3/16" | X | 6-1/2" | 4" | 4-PLUS | 1 | \$6.81 |
| 715S61264-B | 3/16" | X | 6-1/2" | 4" | 4-PLUS | 25 | \$161.74 |
| 715S81264 | 3/16" | X | 8-1/2" | 6" | 4-PLUS | 1 | \$9.42 |
| 715S81264-B | 3/16" | X | 8-1/2" | 6" | 4-PLUS | 25 | \$223.73 |
| 715S10316 | 3/16" | X | 10-1/2" | 8" | 4-PLUS | 1 | \$12.50 |
| 715S12316 | 3/16" | X | 12-1/2" | 10" | 4-PLUS | 1 | \$15.50 |
| 715S14316 | 3/16" | X | 14" | 12" | 4-PLUS | 1 | \$22.59 |
| 715S16316 | 3/16" | X | 16" | 14" | 4-PLUS | 1 | \$29.66 |
| 715S20316 | 3/16" | X | 20" | 18" | 4-PLUS | 1 | \$48.42 |
| 715S24316 | 3/16" | X | 24" | 22" | 4-PLUS | 1 | \$57.60 |
| 715S41464 | 7/32" | X | 4-1/2" | 2" | 4-PLUS | 1 | \$6.99 |
| 715S61464 | 7/32" | X | 6-1/2" | 4" | 4-PLUS | 1 | \$7.22 |
| 715S81464 | 7/32" | X | 8-1/2" | 6" | 4-PLUS | 1 | \$8.97 |
| 715S11732 | 7/32" | X | 10-1/2" | 8" | 4-PLUS | 1 | \$16.21 |
| 715S16732 | 7/32" | X | 16" | 14" | 4-PLUS | 1 | \$28.21 |
| 715S20732 | 7/32" | X | 20" | 18" | 4-PLUS | 1 | \$46.11 |
| 715S24732 | 7/32" | X | 24" | 22" | 4-PLUS | 1 | \$54.86 |
| 715S41664 | 1/4" | X | 4-1/2" | 2" | 4-PLUS | 1 | \$5.97 |
| 715S41664-B | 1/4" | X | 4-1/2" | 2" | 4-PLUS | 25 | \$141.79 |
| 715S61664 | 1/4" | X | 6-1/2" | 4" | 4-PLUS | 1 | \$6.25 |
| 715S61664-B | 1/4" | X | 6-1/2" | 4" | 4-PLUS | 25 | \$148.44 |
| 715S81664 | 1/4" | X | 8-1/2" | 6" | 4-PLUS | 1 | \$8.97 |
| 715S81664-B | 1/4" | X | 8-1/2" | 6" | 4-PLUS | 25 | \$213.04 |
| 715S11014 | 1/4" | X | 10-1/2" | 8" | 4-PLUS | 1 | \$11.45 |
| 715S14014 | 1/4" | X | 14" | 12" | 4-PLUS | 1 | \$22.45 |
| 715S16014 | 1/4" | X | 16" | 14" | 4-PLUS | 1 | \$26.22 |
| 715S20014 | 1/4" | X | 20" | 18" | 4-PLUS | 1 | \$35.24 |
| 715S24014 | 1/4" | X | 24" | 22" | 4-PLUS | 1 | \$40.54 |
| 715S62064 | 5/16" | X | 6-1/2" | 4" | 4-PLUS | 1 | \$8.31 |
| 715S62064-B | 5/16" | X | 6-1/2" | 4" | 4-PLUS | 25 | \$197.36 |
| 715S82064 | 5/16" | X | 8-1/2" | 6" | 4-PLUS | 1 | \$11.02 |
| 715S12516 | 5/16" | X | 12-1/2" | 10" | 4-PLUS | 1 | \$20.75 |
| 715S62464 | 3/8" | X | 6-1/2" | 4" | 4-PLUS | 1 | \$9.03 |
| 715S62464-B | 3/8" | X | 6-1/2" | 4" | 4-PLUS | 25 | \$214.46 |
| 715S82464 | 3/8" | X | 8-1/2" | 6" | 4-PLUS | 1 | \$10.42 |
| 715S10038 | 3/8" | X | 10-1/2" | 8" | 4-PLUS | 1 | \$14.61 |
| 715S12038 | 3/8" | X | 12-1/2" | 10" | 4-PLUS | 1 | \$18.53 |
| 715S12038-B | 3/8" | X | 12-1/2" | 10" | 4-PLUS | 10 | \$176.04 |
| 715S18038 | 3/8" | X | 18" | 16" | 4-PLUS | 1 | \$28.72 |
| 715S24038 | 3/8" | X | 24" | 22" | 4-PLUS | 1 | \$36.39 |
| 715S62864 | 7/16" | X | 6-1/2" | 4" | 4-PLUS | 1 | \$12.44 |
| 715S10716 | 7/16" | X | 10-1/2" | 8" | 4-PLUS | 1 | \$17.56 |
| 715S12716 | 7/16" | X | 12-1/2" | 10" | 4-PLUS | 1 | \$20.56 |
| 715S18716 | 7/16" | X | 18" | 16" | 4-PLUS | 1 | \$31.33 |

BOHR HAMMER

SDS-PLUS Rotary Hammer Drills

| Part # | Size | X | OAL | Drilling | Head | Qty. | List |
|-------------|--------|---|---------|----------|--------|------|----------|
| 715S63264 | 1/2" | X | 6-1/2" | 4" | 4-PLUS | 1 | \$10.39 |
| 715S63264-B | 1/2" | X | 6-1/2" | 4" | 4-PLUS | 25 | \$246.76 |
| 715S10012 | 1/2" | X | 10-1/2" | 8" | 4-PLUS | 1 | \$17.93 |
| 715S12012 | 1/2" | X | 12-1/2" | 10" | 4-PLUS | 1 | \$21.56 |
| 715S12012-B | 1/2" | X | 12-1/2" | 10" | 4-PLUS | 10 | \$185.82 |
| 715S12018 | 1/2" | X | 18" | 16" | 4-PLUS | 1 | \$30.02 |
| 715S12024 | 1/2" | X | 24" | 22" | 4-PLUS | 1 | \$47.10 |
| 715S63664 | 9/16" | X | 6-1/4" | 4" | 4-PLUS | 1 | \$16.10 |
| 715S10916 | 9/16" | X | 10-1/4" | 8" | 4-PLUS | 1 | \$21.79 |
| 715S12916 | 9/16" | X | 12-1/4" | 10" | 4-PLUS | 1 | \$25.14 |
| 715S18916 | 9/16" | X | 18" | 16" | 4-PLUS | 1 | \$32.60 |
| 715S64064 | 5/8" | X | 6-1/4" | 4" | 4-PLUS | 1 | \$12.83 |
| 715S84064 | 5/8" | X | 8-1/4" | 6" | 4-PLUS | 1 | \$18.43 |
| 715S84064-B | 5/8" | X | 8-1/4" | 6" | 4-PLUS | 10 | \$175.09 |
| 715S12058 | 5/8" | X | 12-1/4" | 10" | 4-PLUS | 1 | \$26.72 |
| 715S18058 | 5/8" | X | 18" | 16" | 4-PLUS | 1 | \$38.19 |
| 715S24058 | 5/8" | X | 24" | 22" | 4-PLUS | 1 | \$47.21 |
| 715S14464 | 11/16" | X | 12" | 10" | 4-PLUS | 1 | \$39.75 |
| 715S84864 | 3/4" | X | 8" | 6" | 4-PLUS | 1 | \$23.72 |
| 715S84864-B | 3/4" | X | 8" | 6" | 4-PLUS | 10 | \$225.34 |
| 715S10034 | 3/4" | X | 10" | 8" | 4-PLUS | 1 | \$29.26 |
| 715S12034 | 3/4" | X | 12" | 10" | 4-PLUS | 1 | \$34.61 |
| 715S12034-B | 3/4" | X | 12" | 10" | 4-PLUS | 5 | \$164.40 |
| 715S18034 | 3/4" | X | 18" | 16" | 4-PLUS | 1 | \$46.35 |
| 715S24034 | 3/4" | X | 24" | 22" | 4-PLUS | 1 | \$60.67 |
| 715S85664 | 7/8" | X | 8" | 6" | 4-PLUS | 1 | \$41.59 |
| 715S85664-B | 7/8" | X | 8" | 6" | 4-PLUS | 5 | \$197.55 |
| 715S10078 | 7/8" | X | 10" | 8" | 4-PLUS | 1 | \$44.48 |
| 715S12078 | 7/8" | X | 12" | 10" | 4-PLUS | 1 | \$46.93 |
| 715S12078-B | 7/8" | X | 12" | 10" | 4-PLUS | 5 | \$222.92 |
| 715S18078 | 7/8" | X | 18" | 16" | 4-PLUS | 1 | \$52.01 |
| 715S86464 | 1" | X | 8" | 6" | 4-PLUS | 1 | \$46.24 |
| 715S10001 | 1" | X | 10" | 8" | 4-PLUS | 1 | \$51.88 |
| 715S10001-B | 1" | X | 10" | 8" | 4-PLUS | 5 | \$246.43 |
| 715S12001 | 1" | X | 12" | 10" | 4-PLUS | 1 | \$54.72 |
| 715S18001 | 1" | X | 18" | 16" | 4-PLUS | 1 | \$73.33 |



4-PLUS

A new, fast and tough serrated carbide tip provides long life, easy centering, and fast drilling through all aggregates, concrete, masonry, brick and natural stone.

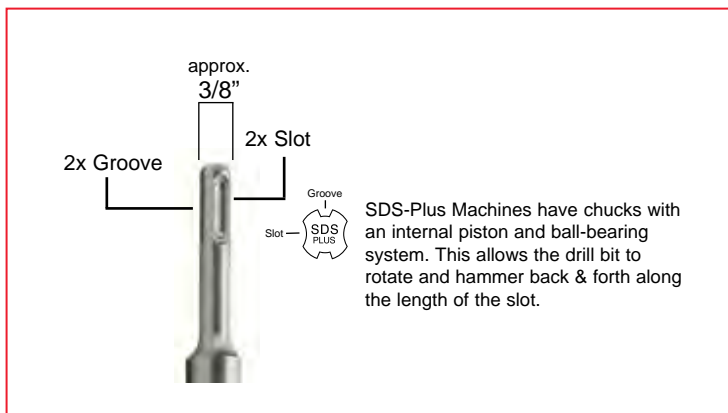

BOHR HAMMER - BULK DRILLS

SDS-PLUS Rotary Hammer Drills

- ◆ Rotary Hammer Drill
- ◆ Serrated Head Geometry
- ◆ Self Centering Chisel Point
- ◆ ANSI Specification
- ◆ Special Tungsten Carbide Tip
- ◆ Copper / Silver Brazing
- ◆ Fastest Dust Removal
- ◆ Fastest Drilling Speeds
- ◆ Clean Round Holes
- ◆ Less Vibration
- ◆ Polished Finish
- ◆ Industrial Quality

- Concrete
- Brick
- Stone
- Masonry
- Aggregates



| Part # | Size | X | OAL | Drilling | Pack | Min.Qty. | List/ea. |
|-----------|-------|---|---------|----------|------|----------|----------|
| 715B41064 | 5/32" | X | 4-1/4" | 2" | BULK | 50 | \$5.97 |
| 715B61064 | 5/32" | X | 6-1/4" | 4" | BULK | 50 | \$6.81 |
| 715B41264 | 3/16" | X | 4-1/2" | 2" | BULK | 50 | \$5.97 |
| 715B61264 | 3/16" | X | 6-1/2" | 4" | BULK | 100 | \$6.81 |
| 715B81264 | 3/16" | X | 8-1/2" | 6" | BULK | 50 | \$9.42 |
| 715B10316 | 3/16" | X | 10-1/2" | 8" | BULK | 25 | \$12.50 |
| 715B12316 | 3/16" | X | 12-1/2" | 10" | BULK | 25 | \$15.50 |
| 715B14316 | 3/16" | X | 14" | 12" | BULK | 25 | \$22.59 |
| 715B16316 | 3/16" | X | 16" | 14" | BULK | 25 | \$29.66 |
| 715B20316 | 3/16" | X | 20" | 18" | BULK | 25 | \$48.42 |
| 715B24316 | 3/16" | X | 24" | 22" | BULK | 25 | \$57.60 |
| 715B41464 | 7/32" | X | 4-1/2" | 2" | BULK | 50 | \$6.99 |
| 715B61464 | 7/32" | X | 6-1/2" | 4" | BULK | 50 | \$7.22 |
| 715B81464 | 7/32" | X | 8-1/2" | 6" | BULK | 50 | \$8.97 |
| 715B11732 | 7/32" | X | 10-1/2" | 8" | BULK | 25 | \$16.21 |
| 715B16732 | 7/32" | X | 16" | 14" | BULK | 25 | \$28.21 |
| 715B20732 | 7/32" | X | 20" | 18" | BULK | 25 | \$46.11 |
| 715B24732 | 7/32" | X | 24" | 22" | BULK | 25 | \$54.86 |



BOHR HAMMER - BULK DRILLS

SDS-PLUS Rotary Hammer Drills

| Part # | Size | X | OAL | Drilling | Pack | Min.Qty. | List/ea. |
|-----------|-------|---|---------|----------|------|----------|----------|
| 715B41664 | 1/4" | X | 4-1/2" | 2" | BULK | 50 | \$5.97 |
| 715B61664 | 1/4" | X | 6-1/2" | 4" | BULK | 100 | \$6.25 |
| 715B81664 | 1/4" | X | 8-1/2" | 6" | BULK | 50 | \$8.97 |
| 715B11014 | 1/4" | X | 10-1/2" | 8" | BULK | 50 | \$11.45 |
| 715B14014 | 1/4" | X | 14" | 12" | BULK | 25 | \$22.45 |
| 715B16014 | 1/4" | X | 16" | 14" | BULK | 25 | \$26.22 |
| 715B20014 | 1/4" | X | 20" | 18" | BULK | 25 | \$35.24 |
| 715B24014 | 1/4" | X | 24" | 22" | BULK | 25 | \$40.54 |
| 715B62064 | 5/16" | X | 6-1/2" | 4" | BULK | 50 | \$8.31 |
| 715B82064 | 5/16" | X | 8-1/2" | 6" | BULK | 25 | \$11.02 |
| 715B12516 | 5/16" | X | 12-1/2" | 10" | BULK | 25 | \$20.75 |
| 715B62464 | 3/8" | X | 6-1/2" | 4" | BULK | 100 | \$9.03 |
| 715B82464 | 3/8" | X | 8-1/2" | 6" | BULK | 50 | \$10.42 |
| 715B10038 | 3/8" | X | 10-1/2" | 8" | BULK | 25 | \$14.61 |
| 715B12038 | 3/8" | X | 12-1/2" | 10" | BULK | 25 | \$18.53 |
| 715B18038 | 3/8" | X | 18" | 16" | BULK | 25 | \$28.72 |
| 715B24038 | 3/8" | X | 24" | 22" | BULK | 25 | \$36.39 |
| 715B63264 | 1/2" | X | 6-1/2" | 4" | BULK | 100 | \$10.39 |
| 715B10012 | 1/2" | X | 10-1/2" | 8" | BULK | 25 | \$17.93 |
| 715B12012 | 1/2" | X | 12-1/2" | 10" | BULK | 25 | \$21.56 |
| 715B12018 | 1/2" | X | 18" | 16" | BULK | 25 | \$30.02 |
| 715B12024 | 1/2" | X | 24" | 22" | BULK | 25 | \$47.10 |



4-PLUS

A new, fast and tough serrated carbide tip provides long life, easy centering, and fast drilling through all aggregates, concrete, masonry, brick and natural stone.

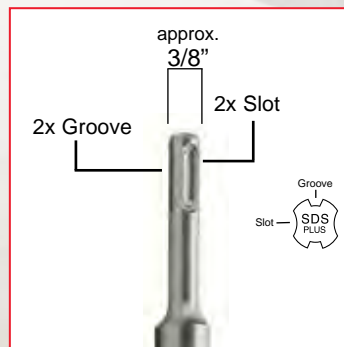



- ◆ Rotary Hammer Drill
- ◆ Self Centering Chisel Point
- ◆ ANSI Specification
- ◆ Special Tungsten Carbide Tip
- ◆ Copper / Silver Brazing
- ◆ Fast Dust Removal
- ◆ Fast Drilling Speeds
- ◆ Clean Round Holes
- ◆ Less Vibration
- ◆ Polished Finish
- ◆ Industrial Quality

- Reinforced Concrete
- Brick
- Stone
- Masonry
- Aggregates



SOLD INDIVIDUALLY.
1 PER TUBE.



X-CUTTER *DRILLS REINFORCED CONCRETE!*

SDS-PLUS Rotary Hammer Drills

| Part # | Size | X | OAL | Drilling | Head | List |
|----------|--------|---|---------|----------|----------|----------|
| 750TE010 | 5/8" | X | 8-1/4" | 6" | X-CUTTER | \$25.23 |
| 750TE020 | 5/8" | X | 10-1/4" | 8" | X-CUTTER | \$26.84 |
| 750TE030 | 5/8" | X | 12-1/4" | 10" | X-CUTTER | \$34.71 |
| 750TE040 | 5/8" | X | 18" | 16" | X-CUTTER | \$44.24 |
| 750TE090 | 3/4" | X | 8" | 6" | X-CUTTER | \$43.46 |
| 750TE100 | 3/4" | X | 10" | 8" | X-CUTTER | \$46.20 |
| 750TE110 | 3/4" | X | 12" | 10" | X-CUTTER | \$52.07 |
| 750TE120 | 3/4" | X | 18" | 16" | X-CUTTER | \$60.38 |
| 750TE140 | 7/8" | X | 8" | 6" | X-CUTTER | \$56.76 |
| 750TE150 | 7/8" | X | 10" | 8" | X-CUTTER | \$60.23 |
| 750TE160 | 7/8" | X | 12" | 10" | X-CUTTER | \$68.20 |
| 750TE170 | 7/8" | X | 18" | 16" | X-CUTTER | \$72.11 |
| 750TE190 | 1" | X | 10" | 8" | X-CUTTER | \$66.49 |
| 750TE200 | 1" | X | 12" | 10" | X-CUTTER | \$79.44 |
| 750TE210 | 1" | X | 18" | 16" | X-CUTTER | \$90.30 |
| 750TE220 | 1-1/8" | X | 10" | 8" | X-CUTTER | \$98.56 |
| 750TE230 | 1-1/8" | X | 18" | 16" | X-CUTTER | \$100.22 |
| 750TE240 | 1-1/4" | X | 18" | 16" | X-CUTTER | \$109.02 |



X-Cutter

- ◆ 4 x 90° Head Symmetry
- ◆ Centering Tip for Pinpoint Accuracy
- ◆ Rebar Chamfers
- ◆ Maximum Carbide / Steel Interface
- ◆ Low Vibration for Increased Rotational Stability
- ◆ ANSI Specification

eVolution™

DRILLS REINFORCED CONCRETE!

SDS-PLUS Rotary Hammer Drills

| Part # | Size | X | OAL | Drilling | Head | Qty. | List |
|------------|-------|---|---------|----------|------|------|----------|
| EVL41064 | 5/32" | X | 4-1/2" | 2" | 4X4 | 1 | \$10.03 |
| EVL61064 | 5/32" | X | 6-1/2" | 4" | 4X4 | 1 | \$11.20 |
| EVL41264 | 3/16" | X | 4-1/2" | 2" | 4X4 | 1 | \$10.30 |
| EVL61264 | 3/16" | X | 6-1/2" | 4" | 4X4 | 1 | \$11.20 |
| EVL61264-B | 3/16" | X | 6-1/2" | 4" | 4X4 | 25 | \$260.67 |
| EVL81264 | 3/16" | X | 8-1/2" | 6" | 4X4 | 1 | \$14.70 |
| EVL10316 | 3/16" | X | 10-1/2" | 8" | 4X4 | 1 | \$20.92 |
| EVL12316 | 3/16" | X | 12-1/2" | 10" | 4X4 | 1 | \$25.78 |
| EVL41664 | 1/4" | X | 4-1/2" | 2" | 4X4 | 1 | \$9.84 |
| EVL61664 | 1/4" | X | 6-1/2" | 4" | 4X4 | 1 | \$10.81 |
| EVL61664-B | 1/4" | X | 6-1/2" | 4" | 4X4 | 25 | \$251.08 |
| EVL81664 | 1/4" | X | 8-1/2" | 6" | 4X4 | 1 | \$13.92 |
| EVL10014 | 1/4" | X | 10-1/2" | 8" | 4X4 | 1 | \$21.31 |
| EVL12014 | 1/4" | X | 12-1/2" | 10" | 4X4 | 1 | \$29.67 |
| EVL62064 | 5/16" | X | 6-1/2" | 4" | 4X4 | 1 | \$12.56 |
| EVL62064-B | 5/16" | X | 6-1/2" | 4" | 4X4 | 25 | \$294.21 |
| EVL12516 | 5/16" | X | 12-1/2" | 10" | 4X4 | 1 | \$23.64 |
| EVL18516 | 5/16" | X | 18" | 16" | 4X4 | 1 | \$34.92 |
| EVL62464 | 3/8" | X | 6-1/4" | 4" | 4X4 | 1 | \$13.92 |
| EVL62464-B | 3/8" | X | 6-1/4" | 4" | 4X4 | 25 | \$327.75 |
| EVL12038 | 3/8" | X | 12-1/4" | 10" | 4X4 | 1 | \$23.64 |
| EVL18038 | 3/8" | X | 18" | 16" | 4X4 | 1 | \$37.84 |
| EVL62864 | 7/16" | X | 6-1/4" | 4" | 4X4 | 1 | \$18.78 |
| EVL12716 | 7/16" | X | 12-1/4" | 10" | 4X4 | 1 | \$27.34 |
| EVL18716 | 7/16" | X | 18" | 16" | 4X4 | 1 | \$38.81 |
| EVL63264 | 1/2" | X | 6-1/4" | 4" | 4X4 | 1 | \$18.28 |
| EVL63264-B | 1/2" | X | 6-1/4" | 4" | 4X4 | 25 | \$433.17 |
| EVL12012 | 1/2" | X | 12-1/4" | 10" | 4X4 | 1 | \$29.09 |
| EVL18012 | 1/2" | X | 18" | 16" | 4X4 | 1 | \$39.39 |
| EVL63664 | 9/16" | X | 6-1/4" | 4" | 4X4 | 1 | \$24.69 |
| EVL12916 | 9/16" | X | 12-1/4" | 10" | 4X4 | 1 | \$36.09 |
| EVL18916 | 9/16" | X | 18" | 16" | 4X4 | 1 | \$49.51 |



- ◆ Rotary Hammer Drill
- ◆ Serrated Head Geometry
- ◆ 4 Symmetrical Functioning Spiral Ridges
- ◆ ANSI Specification
- ◆ Drills Reinforced Concrete
- ◆ 50% More Holes
- ◆ Optimized Core Ensures Impact Durability and Rotational Stability
- ◆ High Break Resistance
- ◆ Less Vibration

- Reinforced Concrete
- Brick
- Stone
- Masonry
- Aggregates



SOLD INDIVIDUALLY.
1 PER CLIP.



4X4-Cutter

- ◆ 4 x 90° Serrated Tip Geometry
- ◆ One-piece, Solid Carbide Tip
- ◆ Centering Tip for Pinpoint Accuracy
- ◆ Rebar Chamfers
- ◆ Maximum Carbide / Steel Interface
- ◆ Low Vibration for Increased Rotational Stability
- ◆ ANSI Specification



For Drop-in Anchors



SDS-PLUS + STOP Rotary Hammer Bit

- ◆ Rotary Hammer Drill
- ◆ STOP - Lip Prevents Over-Drilling
- ◆ Drill Exact Depth For Drop-In Anchor
- ◆ Less Likely to Hit Rebar
- ◆ ANSI Specification



| Part # | Size | Drill Depth | Anchor Size | Qty. | List |
|----------|------|-------------|-------------|------|---------|
| STP-617 | 3/8" | 1-1/16" | 1/4" | 1 | \$24.75 |
| STP-813 | 1/2" | 13/16" | 3/8" Short | 1 | \$27.50 |
| STP-827 | 1/2" | 1-11/16" | 3/8" | 1 | \$28.88 |
| STP-1019 | 5/8" | 1-3/16" | 1/2" Short | 1 | \$30.92 |
| STP-1033 | 5/8" | 2-1/16" | 1/2" | 1 | \$35.13 |
| STP-418 | 7/8" | 2-5/8" | 5/8" | 1 | \$38.64 |
| STP-419 | 1" | 3-1/4" | 3/4" | 1 | \$45.59 |

Use Your SDS-Plus Drill Bits In Larger SDS-MAX® Or Spline Drive Machines:

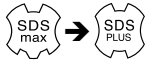

Adapter

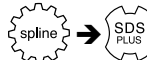

Adapter

SDS-MAX® to SDS-PLUS

| Part # | Description | List |
|-----------|-----------------------------|----------|
| 725MAX001 | SDS-MAX To SDS-Plus Adapter | \$114.15 |



Spline to SDS-PLUS

| Part # | Description | List |
|----------|----------------------------|----------|
| 725SP001 | Spline To SDS-Plus Adapter | \$118.12 |



Replacement Kit - FOR ADAPTERS

| Part # | Description | List |
|-----------|-------------------------|--------|
| 715KIT001 | Gaskets & Ball Bearings | \$4.50 |

SDS-Max to SDS-Plus Adapter



Half Flat Shank



Concrete Bits - FOR CONCRETE SCREWS

| Part # | Size | x | OAL | Screw | Qty. | List |
|-----------|-------|---|--------|-------|------|--------|
| 602TC0503 | 5/32" | X | 3-1/2" | 12 | 50 | \$3.17 |
| 602TC0500 | 5/32" | X | 4-1/2" | 12 | 50 | \$3.31 |
| 602TC0505 | 5/32" | X | 5-1/2" | 12 | 50 | \$3.60 |
| 602TC0603 | 3/16" | X | 3-1/2" | 14 | 50 | \$3.60 |
| 602TC0604 | 3/16" | X | 4-1/2" | 14 | 50 | \$3.73 |
| 602TC0605 | 3/16" | X | 5-1/2" | 14 | 50 | \$4.01 |
| 602TC0606 | 3/16" | X | 6-3/4" | 14 | 50 | \$4.72 |
| 602TC0607 | 3/16" | X | 7-5/8" | 14 | 50 | \$5.67 |

- ◆ Industrial Quality
- ◆ Tungsten Carbide Tip
- ◆ ANSI Specification



Each concrete screw carbide drill bit is precisely ground to match a certain tolerance to assure proper hole diameter and to achieve maximum thread holding power. The flat on the shank fits all drill adapters. The drill bit is specially heat treated to make it very durable.



SDS-HEX Bits - FOR CONCRETE SCREWS

| Part # | Size | x | OAL | Drilling | Qty. | List |
|---------|-------|---|-----|----------|------|---------|
| HEX5325 | 5/32" | X | 5" | 2-1/2" | 1 | \$10.92 |
| HEX5327 | 5/32" | X | 7" | 4-1/2" | 1 | \$12.17 |
| HEX3165 | 3/16" | X | 5" | 2-1/2" | 1 | \$10.92 |
| HEX3167 | 3/16" | X | 7" | 4-1/2" | 1 | \$12.17 |
| HEX2345 | .234 | X | 5" | 2-1/2" | 1 | \$10.92 |
| HEX2347 | .234 | X | 7" | 4-1/2" | 1 | \$12.17 |

- ◆ Industrial Quality
- ◆ Special Tungsten Carbide Tip
- ◆ ANSI Specification
- ◆ Copper / Silver Brazing
- ◆ Polished Finish



SDS-HEX Rotary Hammer drill bits are specifically designed to be used in concrete screw installation. These SDS bits have a special 5/16" HEX shoulder for use with standard concrete screw installation sleeves, which eliminate the need for drill adapters. The benefits of using an SDS machine rather than a standard rotation drill means a decrease in operation time of nearly 50%. **SEE BELOW FOR INSTALLATION KIT**



Concrete Screw Installation Sleeve

| Part # | Description | Qty. | List |
|--------|------------------------------|------|---------|
| TPCDSL | 6-1/2" Concrete Screw Sleeve | 1 | \$18.25 |



Installation Kit

| Part # | Description | List |
|-----------|------------------|---------|
| 602TC1000 | Installation Kit | \$70.00 |

- INCLUDES:**
- 5/32" x 7" SDS-PLUS Hex Bit
 - 3/16" x 7" SDS-PLUS Hex Bit
 - 1/4" Magnetic Driver
 - 5/16" Magnetic Driver
 - Phillips Bit Adapter
 - Masonry Drill Adapter
 - 6-1/2" Sleeve
 - 1/8" Hex Key
 - Phillips #2 x 1" Insert
 - Phillips #3 x 1" Insert

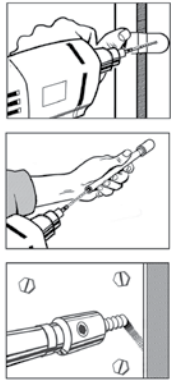

- ◆ Red Case
- ◆ Black Hardware

This Installation Kit is Suitable for both Standard Concrete Bits & SDS-HEX Rotary Hammer Bits.



SDS-PLUS ROTARY HAMMER DRILL MACHINES

| BOSCH | DEWALT | HILTI | HITACHI | MAKITA | MILWAUKEE | METABO |
|-------------|---------|--------------|---------|---------|-----------|---------|
| 11207 | D25012K | TE 1 | DH18DL | BHR202 | 0756-22 | 6010 |
| 11210 | D25023K | TE 2 | DH22PG | BHR241 | 2412-20 | 6011 |
| 11211 | D25111K | TE 2-A | DH24 | HR160 | 2416-20XC | 6015 |
| 11212 | D25123K | TE 2-A18 | DH24PF3 | HR1821 | 2605-20 | 6018 |
| 11215 | D25133K | TE 2-M | DH25 | HR1830 | 2612-22 | 6020 |
| 11524 | D25211K | TE 2-S | DH28 | HR1830F | 2712-22 | 6021 |
| 11213RK | D25213K | TE 4-A18 | DH28PC | HR2000 | 2715-22 | 6024 |
| 11221DVS | D25223K | TE 4-A22 | DH28PD | HR2010 | 5262 | 6026 |
| 11222EVS/G | D25211K | TE 6-A36-AVR | DH30 | HR2400 | 5262-21 | 6028 |
| 11224VSR | D25213K | TE 6-S | H30PV | HR2410 | 5263 | BHA18 |
| 11225VSR/H | D25223K | TE 7 | VR16 | HR2420 | 5263-21 | BHE22 |
| 11228VSR | D25260K | TE 7-A | VRT22 | HR2431 | 5268-21 | BHE2243 |
| 11234VSR | D25262K | TE 7-C | | HR2432 | 5302 | BHE24 |
| 11236VS | D25263K | TE 30 | | HR2450 | 5303 | BHE2444 |
| 11239VS | D25313K | TE 30-A36 | | HR2455 | 5312 | BHE2644 |
| 11250VSR | D25323K | TE 30-C-AVR | | HR2470F | 5320 | BHE6015 |
| 11250VSRD | D25324K | TE 30-M-AVR | | HR2475 | 5324 | KHE24 |
| 11253VSR | D25404K | TE 40 | | HR2511 | 5342 | KHE2444 |
| 11255VSR | D25413K | TE 40-AVR | | HR2611F | 5359 | KHE2640 |
| 11536C-1(2) | D25416K | TE A-36AVR | | HR2621 | 5359-21 | KHE2644 |
| 11536VSR | | TE/GP 22 | | HR2811F | 5360 | KHE3650 |
| RH228VC | | | | HR3000C | 5362 | KHE28 |
| RH328VC(Q) | | | | HR3210C | 5363 | KHE2851 |
| RH432VC(Q) | | | | | 5363-21 | KHE32 |
| RHH181-01 | | | | | 5365 | KHE3250 |
| RHH181BL | | | | | 5366 | KHE3251 |
| RHS181B | | | | | 5368 | UHE22 |
| RHS181K | | | | | 5369 | UHE2250 |
| | | | | | 5383 | UHE2450 |
| | | | | | V28 | UHE2650 |
| | | | | | | UHE28 |
| | | | | | | UHE2850 |



SDS-MAX ROTARY HAMMER DRILL MACHINES

| BOSCH | DEWALT | HILTI | HITACHI | MAKITA | MILWAUKEE | METABO |
|----------|---------|--------------|----------|---------|-----------|----------|
| 11214EVS | 25600K | TE-F 52 | DH38MS | HR4000C | 5308 | 6045 |
| 1223 | 2570K | TE-F 60 | DH40MA | HR4001C | 5313 | KHE 5-40 |
| 1227 | 541K | TE-F 72 | DH40MB | HR4002 | 5314 | KHE56 |
| 1230 | 545K | TE-F 92 | DH40MR Y | HR4002C | 5315 | KHE76 |
| 11216 | D25501K | TE-Y 54 | DH45MR | HR4010C | 5317 | KHE96 |
| 11231 | D25601K | TE-Y 55 | DH50MR Y | HR4013C | 5317-21 | |
| 11235 | D25602K | TE-Y 56 | H60HR | HR4500C | 5342 | |
| 11240 | D25603K | TE-Y 70 | | HR4510C | 5342-21 | |
| 11241 | D25712K | TE-Y 74 | | HR5001C | 5346 | |
| 11245 | D25721K | TE-Y 75 | | HR5210C | 5426 | |
| 11245EVS | D25723K | TE-Y 76 | | HR5212C | 5426-1 | |
| 11263 | D25761K | TE50 | | | 5446 | |
| 11263EVS | D25762K | TE60 | | | | |
| 11264 | D25763K | TE60-ATC/AVR | | | | |
| 11264EVS | | TE70 | | | | |
| RH540M | | TE70-ATC/AVR | | | | |
| RH745 | | TE80-ATC/AVR | | | | |
| RH850VC | | | | | | |



SPLINE DRIVE ROTARY HAMMER DRILL MACHINES

| BOSCH | DEWALT | HILTI | HITACHI | MAKITA | MILWAUKEE | METABO |
|----------|---------|-------|---------|---------|-----------|--------|
| 11202 | D25651K | N/A | DH38YE2 | HR3851 | 5309 | N/A |
| 11203 | D25553K | | DH40FR | HR4040C | 5311 | |
| 11204 | 530K | | DS50SBK | HR4041C | 5316 | |
| 11205 | 531K | | | HR5000 | 5316-21 | |
| 11209 | 532K | | | | 5317 | |
| 11214 | 533K | | | | 5318 | |
| 11219 | | | | | 5319 | |
| 11220 | | | | | 5321 | |
| 11232 | | | | | 5340-21 | |
| 11233 | | | | | 5341 | |
| 11247 | | | | | 5343 | |
| 11248 | | | | | 5344 | |
| 11244E | | | | | 5347 | |
| 11265EVS | | | | | 5348 | |
| RH540S | | | | | 5352 | |
| | | | | | 5345 | |

X-CUTTER DRILLS REINFORCED CONCRETE!

SDS-MAX® Rotary Hammer Drills

| Part # | Size | X | OAL | Drilling | Head | List |
|----------|---------|---|-----|----------|----------|----------|
| SMTE1338 | 3/8" | X | 13" | 7-1/2" | REGULAR | \$45.79 |
| SMTE1312 | 1/2" | X | 13" | 7-1/2" | REGULAR | \$44.29 |
| SMTE1712 | 1/2" | X | 17" | 12" | REGULAR | \$55.43 |
| SMTE2212 | 1/2" | X | 21" | 15-1/2" | REGULAR | \$58.49 |
| SMTE1391 | 9/16" | X | 13" | 7-1/2" | REGULAR | \$68.72 |
| SMTE2192 | 9/16" | X | 21" | 15-1/2" | REGULAR | \$89.71 |
| SMTE1358 | 5/8" | X | 13" | 7-1/2" | X-CUTTER | \$53.44 |
| SMTE1758 | 5/8" | X | 17" | 12" | X-CUTTER | \$60.80 |
| SMTE2258 | 5/8" | X | 21" | 15-1/2" | X-CUTTER | \$64.61 |
| SMTE3658 | 5/8" | X | 36" | 30-1/2" | X-CUTTER | \$139.79 |
| SMTE2111 | 11/16" | X | 21" | 15-1/2" | X-CUTTER | \$93.42 |
| SMTE1334 | 3/4" | X | 13" | 8" | X-CUTTER | \$55.40 |
| SMTE1734 | 3/4" | X | 17" | 12" | X-CUTTER | \$65.63 |
| SMTE2234 | 3/4" | X | 21" | 17" | X-CUTTER | \$72.24 |
| SMTE3634 | 3/4" | X | 36" | 31" | X-CUTTER | \$152.62 |
| SMTE2113 | 13/16" | X | 21" | 17" | X-CUTTER | \$99.29 |
| SMTE1378 | 7/8" | X | 13" | 8" | X-CUTTER | \$65.23 |
| SMTE1778 | 7/8" | X | 17" | 12" | X-CUTTER | \$74.77 |
| SMTE2278 | 7/8" | X | 21" | 17" | X-CUTTER | \$78.85 |
| SMTE3678 | 7/8" | X | 36" | 31" | X-CUTTER | \$201.56 |
| SMTE1301 | 1" | X | 13" | 8" | X-CUTTER | \$71.37 |
| SMTE1701 | 1" | X | 17" | 12" | X-CUTTER | \$82.44 |
| SMTE2201 | 1" | X | 21" | 17" | X-CUTTER | \$86.65 |
| SMTE3601 | 1" | X | 36" | 31" | X-CUTTER | \$214.18 |
| SMTE2311 | 1-1/16" | X | 23" | 18" | X-CUTTER | \$117.16 |
| SMTE1718 | 1-1/8" | X | 17" | 12" | X-CUTTER | \$94.64 |
| SMTE2218 | 1-1/8" | X | 21" | 17" | X-CUTTER | \$111.93 |
| SMTE3618 | 1-1/8" | X | 36" | 31" | X-CUTTER | \$242.70 |
| SMTE2313 | 1-3/16" | X | 23" | 18" | X-CUTTER | \$144.41 |
| SMTE1714 | 1-1/4" | X | 15" | 10" | X-CUTTER | \$122.87 |
| SMTE2214 | 1-1/4" | X | 23" | 18" | X-CUTTER | \$131.29 |
| SMTE3614 | 1-1/4" | X | 36" | 31" | X-CUTTER | \$256.60 |
| SMTE1738 | 1-3/8" | X | 17" | 12" | X-CUTTER | \$137.07 |
| SMTE2238 | 1-3/8" | X | 23" | 18" | X-CUTTER | \$144.49 |
| SMTE3638 | 1-3/8" | X | 36" | 31" | X-CUTTER | \$289.82 |
| SMTE1721 | 1-1/2" | X | 17" | 12" | X-CUTTER | \$169.44 |
| SMTE2221 | 1-1/2" | X | 23" | 18" | X-CUTTER | \$214.98 |
| SMTE2334 | 1-3/4" | X | 23" | 18" | X-CUTTER | \$304.16 |
| SMTE2202 | 2" | X | 23" | 18" | X-CUTTER | \$337.26 |



- ◆ Rotary Hammer Drill
- ◆ Industrial Quality
- ◆ Special Tungsten Carbide Tip
- ◆ Copper / Silver Brazing
- ◆ Fastest Dust Removal
- ◆ Fastest Drilling Speeds
- ◆ Heat Treated Body
- ◆ Clean Round Holes
- ◆ Less Vibration
- ◆ Polished Finish
- ◆ ANSI Specification

- ➔ Reinforced Concrete
- ➔ Brick
- ➔ Stone
- ➔ Masonry
- ➔ Aggregates



SOLD INDIVIDUALLY.
1 PER TUBE.



Extensions on Page 92.

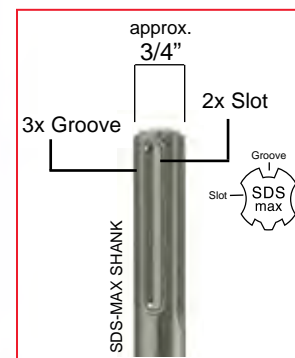

Bosch® License

X-Tend Your Drilling Depths!



Drill bit extension system for all SDS-Max & Spline machines.

- ◆ X-Tend Any SDS-MAX Tool
- ◆ Quick & Safe Connection
- ◆ Simple To Use
- ◆ No Energy Loss
- ◆ No Weak Points
- ◆ Saves Time & Money
- ◆ Reduces Tool Requirements

How it works:

- X-Tendr™ Adapter has double locking SDS-MAX inputs.
- All EXTENSION SHAFTS have 1 SDS-MAX end which locks into X-Tendr™ Adapter. Other end can be inserted into either an SDS-MAX or Spline machine.
- X-Tend any SDS-MAX drill bit, core bit, tunnel bore drill, drill head, or chisel.
- Reach of X-Tendr™ system limited to 1 adapter and 1 extension.



X-Tendr™ - MAX to MAX SHANK ADAPTER

| Part # | Description | List |
|--------|----------------------------|----------|
| XT6700 | Adapter (1-3/16" x 7-1/2") | \$384.25 |
| XT6750 | Adapter Grease (Tube) | \$7.17 |

Drill Bit Diameter Must Be 1-1/4" Or Larger if X-Tendr™ is to Pass Through Hole Being Drilled.



SDS-Max Shaft



Spline Shaft

X-Tendr™ Extension Shafts

| Part # | OAL | Shank | List |
|--------|---------|---------|----------|
| XT6701 | 12-1/2" | SDS-MAX | \$60.67 |
| XT6702 | 30" | SDS-MAX | \$74.58 |
| XT6703 | 44" | SDS-MAX | \$101.79 |
| XT6708 | 12-1/2" | SPLINE | \$74.28 |
| XT6709 | 30" | SPLINE | \$92.98 |



1. Choose either SDS-MAX or SPLINE Drive and desired length Extension.



2. Attach X-Tendr™ Adaptor to SDS-MAX end of Extension.



3. Attach desired SDS-MAX Rotary Hammer Drill Bit, Core Bit, Tunnel Bore Drill or Chisel.

Drill Bit Diameter Must Be 1-1/4" Or Larger if X-Tendr™ is to Pass Through Hole Being Drilled.

X-TEND YOUR OPTIONS...





Exacto™ Center Pin

| Part # | Size | List |
|---------|---|---------|
| EXA-CP0 | #0 CENTER PIN (FOR 1" & 1-1/8") | \$67.88 |
| EXA-CP1 | #1 CENTER PIN (FOR 1-1/4", 1-3/8" & 1-1/2") | \$67.92 |
| EXA-CP2 | #2 CENTER PIN (FOR 1-3/4" THRU 3-7/8") | \$67.92 |



GUIDE PLATE INCLUDED WITH EACH CORE BIT



Exacto™ Carbide Core Bit - 4" OAL

| Part # | Size | # Teeth | Pin | Shank | List |
|----------|---------|---------|---------|----------|----------|
| EXA-25C | 1" | 5 | EXA-CPO | EXA-S1-8 | \$180.25 |
| EXA-29C | 1-1/8" | 5 | EXA-CPO | EXA-S1-8 | \$192.21 |
| EXA-32C | 1-1/4" | 6 | EXA-CP1 | EXA-S1-8 | \$213.92 |
| EXA-35C | 1-3/8" | 6 | EXA-CP1 | EXA-S1-8 | \$237.88 |
| EXA-38C | 1-1/2" | 7 | EXA-CP1 | EXA-S1-8 | \$264.21 |
| EXA-45C | 1-3/4" | 8 | EXA-CP2 | EXA-S2-8 | \$300.25 |
| EXA-50C | 2" | 9 | EXA-CP2 | EXA-S2-8 | \$319.54 |
| EXA-55C | 2-1/8" | 10 | EXA-CP2 | EXA-S2-8 | \$336.08 |
| EXA-65C | 2-9/16" | 12 | EXA-CP2 | EXA-S2-8 | \$386.58 |
| EXA-80C | 3-1/8" | 16 | EXA-CP2 | EXA-S2-8 | \$472.92 |
| EXA-90C | 3-1/2" | 16 | EXA-CP2 | EXA-S2-8 | \$540.25 |
| EXA-100C | 3-7/8" | 16 | EXA-CP2 | EXA-S2-8 | \$602.67 |



Exacto™ SDS-Plus Extension

| Part # | Size | List |
|-----------|--|----------|
| EXA-S1-8 | 8" EXTENSION (FOR 1" THRU 1-1/2") | \$59.54 |
| EXA-S1-12 | 12" EXTENSION (FOR 1" THRU 1-1/2") | \$70.58 |
| EXA-S2-8 | 8" EXTENSION (FOR 1-3/4" THRU 3-7/8") | \$79.25 |
| EXA-S2-12 | 12" EXTENSION (FOR 1-3/4" THRU 3-7/8") | \$104.54 |



- ◆ Industrial Quality
- ◆ Tungsten Carbide Teeth
- ◆ Thin Wall Body
- ◆ Cutting Depth 2-3/4"
- ◆ Use Rotary Hammer Action
- ◆ Clean Round Holes

- Concrete
- Brick
- Stone
- Masonry
- Aggregates





Pilot Drill - A-TAPER FOR EXTENSION

| Part # | Size | List |
|-----------|-------------------|---------|
| 721PD0385 | 3/8" X 6" A-TAPER | \$11.63 |

Ejector Key

| Part # | Description | List |
|-----------|-------------|--------|
| 722EJ0001 | EJECTOR KEY | \$9.39 |



Carbide Core Bit - 4" OAL / TAPER

| Part # | Size | # Teeth | List |
|-----------|------------------|---------|----------|
| 719CB0040 | 1-1/2" | 6 | \$115.52 |
| 719CB0050 | 2" | 6 | \$137.36 |
| 719CB0065 | 2-1/2" | 9 | \$148.90 |
| 719CB0080 | 3" (3-1/8") | 9 | \$194.80 |
| 719CB0090 | 3-1/2" (3-9/16") | 9 | \$219.75 |
| 719CB0100 | 4" | 9 | \$283.12 |
| 719CB0125 | 5" | 12 | \$377.60 |

All 3-1/2" Diameter Core Bits Are Now 3-9/16"

These Heavy Duty Rotary Hammer Core Bits are used with either Spline or SDS-MAX electric rotary hammer machines. The special alloy steel body and Tungsten Carbide withstand continuous hammering. A pilot drill bit and extension are required.



GERMANY

TAPER



Taper Shank Extensions



SPLINE DRIVE

| Part # | Size | Shank | List |
|-----------|------|--------|---------|
| 720SP0008 | 8" | SPLINE | \$73.60 |
| 720SP0018 | 18" | SPLINE | \$90.58 |



SDS - MAX®

| Part # | Size | Shank | List |
|-----------|------|---------|----------|
| 720MAX008 | 8" | SDS-MAX | \$83.83 |
| 720MAX018 | 18" | SDS-MAX | \$102.44 |



Notice: Core Bit drilling without the use of a pilot drill bit causes excessive pressure on the taper shank system. This can result in breakage to the extension at the tapered end, especially between the two slots. Such jagged breaks are not considered defective and may not be covered under warranty.

1-Pc SDS-MAX® Core Bits

| Part # | Size | X | OAL | # Teeth | Shank | List |
|-----------|---------|---|-----|---------|---------|----------|
| 990HH1015 | 1-1/2" | X | 12" | 4 | SDS-MAX | \$247.91 |
| 990HH1025 | 1-1/2" | X | 22" | 4 | SDS-MAX | \$296.97 |
| 990HH1155 | 1-3/4" | X | 12" | 6 | SDS-MAX | \$262.21 |
| 990HH1165 | 1-3/4" | X | 22" | 6 | SDS-MAX | \$293.04 |
| 990HH1035 | 2" | X | 12" | 6 | SDS-MAX | \$271.34 |
| 990HH1045 | 2" | X | 22" | 6 | SDS-MAX | \$318.29 |
| 990HH1055 | 2-5/8" | X | 12" | 8 | SDS-MAX | \$308.22 |
| 990HH1065 | 2-5/8" | X | 22" | 8 | SDS-MAX | \$354.74 |
| 990HH1075 | 3-1/8" | X | 12" | 8 | SDS-MAX | \$385.91 |
| 990HH1085 | 3-1/8" | X | 22" | 8 | SDS-MAX | \$428.50 |
| 990HH1095 | 3-9/16" | X | 12" | 10 | SDS-MAX | \$403.46 |
| 990HH1105 | 3-9/16" | X | 22" | 10 | SDS-MAX | \$447.78 |
| 990HH1115 | 4" | X | 12" | 10 | SDS-MAX | \$453.03 |
| 990HH1125 | 4" | X | 22" | 10 | SDS-MAX | \$483.52 |
| 990HH1215 | 5" | X | 12" | 14 | SDS-MAX | \$515.58 |
| 990HH1135 | 5" | X | 22" | 14 | SDS-MAX | \$546.54 |
| 990HH1145 | 6" | X | 22" | 18 | SDS-MAX | \$716.08 |

All 3-1/2" Diameter Core Bits Are Now 3-9/16"

1-Pc Spline Core Bits

| Part # | Size | X | OAL | # Teeth | Shank | List |
|-----------|---------|---|-----|---------|--------|----------|
| 920HH1505 | 1-1/2" | X | 12" | 4 | SPLINE | \$253.35 |
| 920HH1515 | 1-1/2" | X | 22" | 4 | SPLINE | \$296.00 |
| 920HH1665 | 1-3/4" | X | 12" | 6 | SPLINE | \$254.81 |
| 920HH1675 | 1-3/4" | X | 22" | 6 | SPLINE | \$291.81 |
| 920HH1525 | 2" | X | 12" | 6 | SPLINE | \$264.79 |
| 920HH1535 | 2" | X | 22" | 6 | SPLINE | \$308.98 |
| 920HH1545 | 2-5/8" | X | 12" | 8 | SPLINE | \$304.80 |
| 920HH1555 | 2-5/8" | X | 22" | 8 | SPLINE | \$348.36 |
| 920HH1565 | 3-1/8" | X | 12" | 8 | SPLINE | \$371.66 |
| 920HH1575 | 3-1/8" | X | 22" | 8 | SPLINE | \$422.45 |
| 920HH1585 | 3-9/16" | X | 12" | 10 | SPLINE | \$391.45 |
| 920HH1595 | 3-9/16" | X | 22" | 10 | SPLINE | \$434.55 |
| 920HH1605 | 4" | X | 12" | 10 | SPLINE | \$448.29 |
| 920HH1615 | 4" | X | 22" | 10 | SPLINE | \$490.58 |
| 920HH1625 | 5" | X | 12" | 14 | SPLINE | \$511.73 |
| 920HH1635 | 5" | X | 22" | 14 | SPLINE | \$541.33 |
| 920HH1655 | 6" | X | 22" | 18 | SPLINE | \$714.73 |

All 3-1/2" Diameter Core Bits Are Now 3-9/16"



Pilot Drill & Key - REPLACEMENT PARTS

| Part # | Size | List |
|-----------|----------------------------|---------|
| 900PD1143 | 7/16" X 4-3/4" PILOT DRILL | \$10.27 |
| 900DK7006 | 3/8" ROUND DRIFT KEY | \$9.80 |



- ◆ Industrial Quality
- ◆ 1 Piece Construction
- ◆ Special Tungsten Carbide Tip
- ◆ Copper / Silver Brazing
- ◆ Clean Round Holes
- ◆ Less Vibration
- ◆ Polished Finish

- ➔ Concrete
- ➔ Brick
- ➔ Stone
- ➔ Masonry
- ➔ Aggregates



Each Core Bit Includes Pilot Drill & Key

SOLD INDIVIDUALLY. 1 PER TUBE.

Asymmetrical Tooth Arrangement For Faster Drilling Process

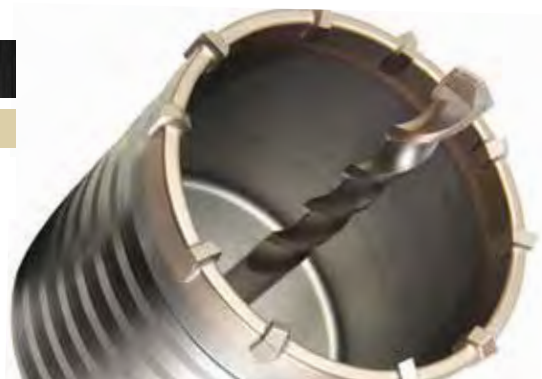

- ◆ Industrial Quality
- ◆ 1 Piece Construction
- ◆ Special Tungsten Carbide Tip
- ◆ Copper / Silver Brazing
- ◆ Fast Drilling Speed
- ◆ Clean Round Holes
- ◆ Less Vibration
- ◆ Polished Finish

- ➔ Concrete
- ➔ Brick
- ➔ Stone
- ➔ Masonry
- ➔ Aggregates



GERMANY

SOLD INDIVIDUALLY.
1 PER TUBE.



SDS-MAX® Tunnel Bore Drills

| Part # | Size | X | OAL | Shank | List |
|-----------|--------|---|-----|---------|----------|
| 950CC7331 | 1-1/2" | X | 22" | SDS-MAX | \$281.87 |
| 950CC7333 | 1-3/4" | X | 22" | SDS-MAX | \$287.20 |
| 950CC7342 | 1-3/4" | X | 39" | SDS-MAX | \$380.63 |
| 950CC7337 | 2-1/8" | X | 22" | SDS-MAX | \$323.83 |
| 950CC7343 | 2-1/8" | X | 39" | SDS-MAX | \$427.15 |
| 950CC7339 | 2-1/2" | X | 22" | SDS-MAX | \$328.94 |
| 950CC7344 | 2-1/2" | X | 39" | SDS-MAX | \$460.98 |
| 950CC7341 | 3-1/8" | X | 22" | SDS-MAX | \$391.75 |
| 950CC7345 | 3-1/8" | X | 39" | SDS-MAX | \$528.65 |



Extensions on Page 92.

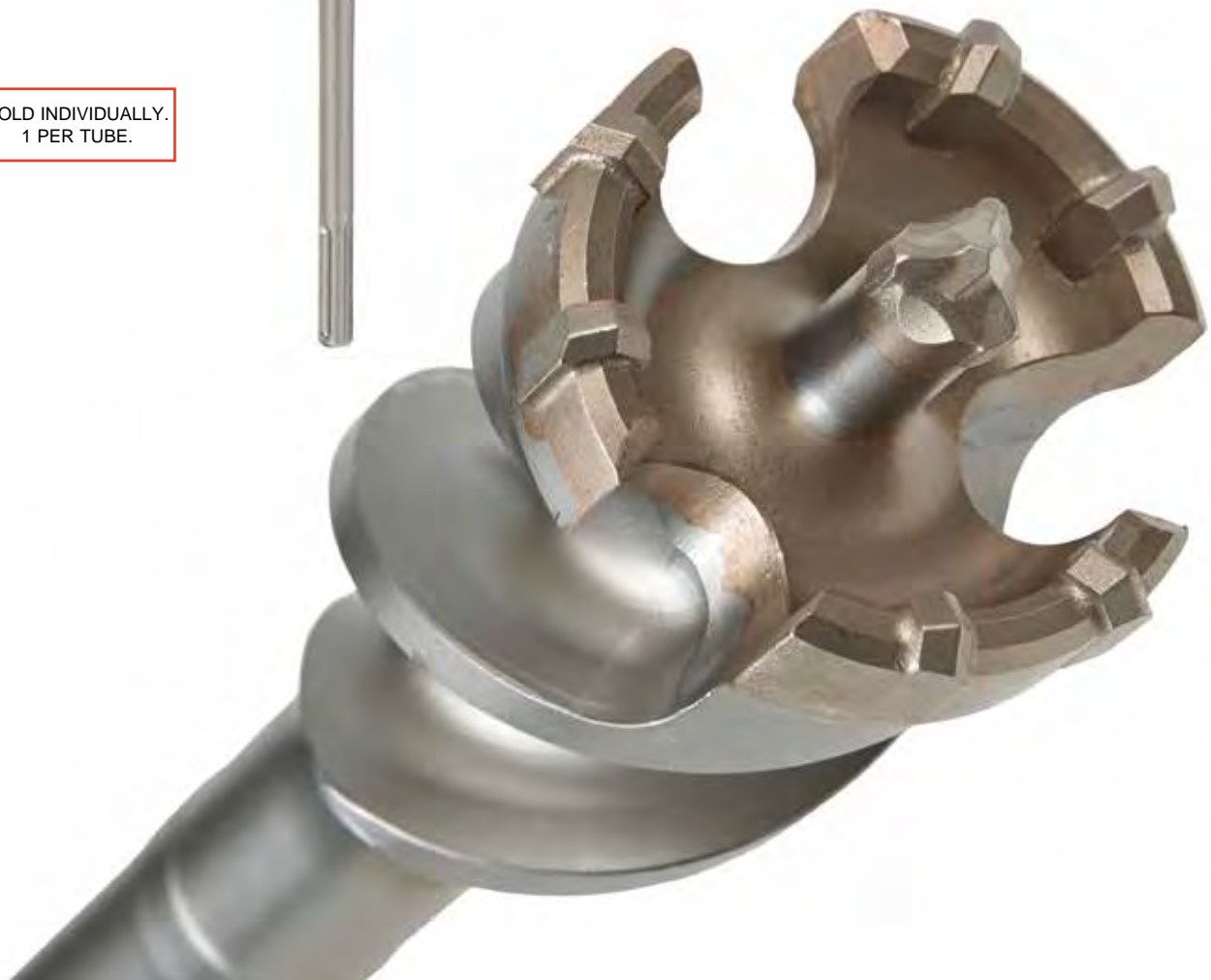

Adapters

| Part # | Description | OAL | List |
|----------|-----------------|-----|---------|
| 800RA010 | SPLINE ADAPTER | 7" | \$78.14 |
| 800RA020 | SDS-MAX ADAPTER | 7" | \$78.14 |



◆ 5/8" - 11 Internal Thread



Pilot Drills

| Part # | Description | List |
|----------|---------------------|---------|
| 800RP124 | 5/8" X 4-3/4" PILOT | \$43.42 |
| 800RP174 | 5/8" X 6-3/4" PILOT | \$46.84 |
| 800RP255 | 1/2" X 6" PILOT | \$35.12 |



- RECOMMENDED.
- BETTER FOR DEEP DRILLING.
- FOR RATIO CORE BIT ONLY!!!

- ◆ Modular System
- ◆ Up to 6" Diameter
- ◆ Allows for Angle Drilling
- ◆ Use With or Without Spiral Flute
- ◆ Adapters Accommodate Any Combination
- ◆ Unmatched Flexibility



Cruciform™ Drill Heads

| Part # | Description | OAL | List |
|----------|-------------------|--------|-----------|
| 800RC040 | 1-1/2" DRILL HEAD | 1-1/2" | \$210.25 |
| 800RC045 | 1-3/4" DRILL HEAD | 1-1/2" | \$242.15 |
| 800RC052 | 2" DRILL HEAD | 1-1/2" | \$275.86 |
| 800RC065 | 2-5/8" DRILL HEAD | 1-1/2" | \$373.33 |
| 800RC080 | 3-1/8" DRILL HEAD | 1-1/2" | \$421.06 |
| 800RC090 | 3-1/2" DRILL HEAD | 1-1/2" | \$491.35 |
| 800RC100 | 4" DRILL HEAD | 1-1/2" | \$526.43 |
| 800RC110 | 4-1/2" DRILL HEAD | 1-1/2" | \$657.94 |
| 800RC125 | 5" DRILL HEAD | 1-1/2" | \$753.36 |
| 800RC150 | 6" DRILL HEAD | 1-1/2" | \$1104.26 |



Replacement Coupler
5/8" - 11 X 2" OAL
800RT001 List \$18.87

Extensions

| Part # | Description | List |
|----------|-------------------------------|----------|
| 800RE300 | 11" LONG EXTENSION | \$122.08 |
| 800RE350 | 12" LONG EVACUATION EXTENSION | \$125.56 |
| 800RE450 | 18" LONG EXTENSION | \$138.64 |



Hard Body Spiral Flutes

| Part # | Description | OAL | List |
|----------|--------------|-----|----------|
| 800RF145 | 1-1/2" FLUTE | 4" | \$121.36 |
| 800RF145 | 1-3/4" FLUTE | 4" | \$121.36 |
| 800RF152 | 2" FLUTE | 4" | \$153.74 |
| 800RF165 | 2-5/8" FLUTE | 4" | \$296.77 |
| 800RF180 | 3-1/8" FLUTE | 4" | \$501.78 |
| 800RF180 | 3-1/2" FLUTE | 4" | \$501.78 |



Same flute fits 1-1/2" & 1-3/4"

Same flute fits 3-1/8" & 3-1/2"

Ratio Core Bits - INTERNAL THREAD

| Part # | Description | OAL | List |
|----------|-----------------|-----|----------|
| 800RK150 | 1-1/2" CORE BIT | 3" | \$162.24 |
| 800RK200 | 2" CORE BIT | 3" | \$169.61 |
| 800RK250 | 2-1/2" CORE BIT | 3" | \$202.80 |
| 800RK300 | 3" CORE BIT | 3" | \$235.95 |
| 800RK350 | 3-1/2" CORE BIT | 3" | \$279.13 |
| 800RK400 | 4" CORE BIT | 3" | \$342.16 |
| 800RK450 | 4-1/2" CORE BIT | 3" | \$430.81 |
| 800RK500 | 5" CORE BIT | 3" | \$463.36 |
| 800RK600 | 6" CORE BIT | 3" | \$548.78 |



USE PILOT DRILL
800RP255 ONLY!!!



All parts sold separately. Drilling through REBAR will cause damage to system.

- ◆ Rotary Hammer Drill
- ◆ Industrial Quality
- ◆ Special Tungsten Carbide Tip
- ◆ Copper / Silver Brazing
- ◆ Fastest Dust Removal
- ◆ Fastest Drilling Speeds
- ◆ Heat Treated Body
- ◆ Clean Round Holes
- ◆ Less Vibration
- ◆ Polished Finish
- ◆ ANSI Specification

- Brick
- Stone
- Masonry
- Aggregates



GERMANY



ANSI

SOLD INDIVIDUALLY.
1 PER TUBE.

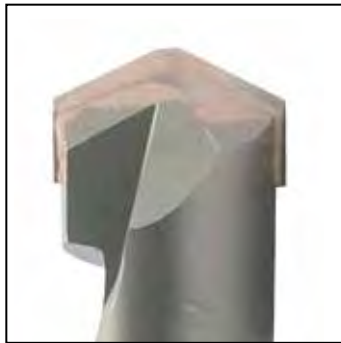
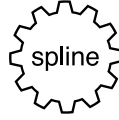

Spline Drive Rotary Hammer Drills

| Part # | Size | X | OAL | Drilling | Head | List |
|-----------|--------|---|-----|----------|---------|----------|
| 717SP1238 | 3/8" | X | 10" | 5" | REGULAR | \$37.80 |
| 717SP1638 | 3/8" | X | 16" | 11" | REGULAR | \$49.19 |
| 717SP1212 | 1/2" | X | 10" | 5" | REGULAR | \$39.84 |
| 717SP1612 | 1/2" | X | 16" | 11" | REGULAR | \$46.47 |
| 717SP2212 | 1/2" | X | 22" | 17" | REGULAR | \$60.39 |
| 717SP2812 | 1/2" | X | 29" | 24" | REGULAR | \$81.38 |
| 717SP3612 | 1/2" | X | 36" | 31" | REGULAR | \$111.08 |
| 717SP1291 | 9/16" | X | 10" | 5" | REGULAR | \$52.96 |
| 717SP1691 | 9/16" | X | 16" | 11" | REGULAR | \$66.91 |
| 717SP2291 | 9/16" | X | 23" | 17" | REGULAR | \$70.27 |
| 717SP2891 | 9/16" | X | 29" | 24" | REGULAR | \$107.98 |
| 717SP1258 | 5/8" | X | 10" | 5" | REGULAR | \$56.32 |
| 717SP1658 | 5/8" | X | 16" | 11" | REGULAR | \$69.75 |
| 717SP2258 | 5/8" | X | 22" | 17" | REGULAR | \$77.50 |
| 717SP3658 | 5/8" | X | 36" | 31" | REGULAR | \$143.47 |
| 717SP1211 | 11/16" | X | 13" | 8" | REGULAR | \$66.39 |
| 717SP1611 | 11/16" | X | 16" | 11" | REGULAR | \$78.79 |
| 717SP1234 | 3/4" | X | 10" | 5" | REGULAR | \$58.38 |
| 717SP1634 | 3/4" | X | 16" | 11" | REGULAR | \$65.88 |
| 717SP2234 | 3/4" | X | 22" | 17" | REGULAR | \$78.02 |
| 717SP3634 | 3/4" | X | 36" | 31" | REGULAR | \$151.39 |
| 717SP1678 | 7/8" | X | 16" | 11" | REGULAR | \$73.63 |
| 717SP2278 | 7/8" | X | 22" | 17" | REGULAR | \$85.28 |
| 717SP3678 | 7/8" | X | 36" | 31" | REGULAR | \$159.56 |
| 717SP1201 | 1" | X | 13" | 8" | REGULAR | \$76.21 |
| 717SP1601 | 1" | X | 16" | 11" | REGULAR | \$82.41 |
| 717SP2201 | 1" | X | 22" | 17" | REGULAR | \$96.88 |
| 717SP3601 | 1" | X | 36" | 31" | REGULAR | \$169.17 |
| 717SP1618 | 1-1/8" | X | 16" | 11" | REGULAR | \$79.40 |
| 717SP2218 | 1-1/8" | X | 22" | 17" | REGULAR | \$128.65 |
| 717SP1614 | 1-1/4" | X | 16" | 11" | REGULAR | \$109.02 |
| 717SP2214 | 1-1/4" | X | 22" | 17" | REGULAR | \$128.65 |
| 717SP3614 | 1-1/4" | X | 36" | 31" | REGULAR | \$189.34 |
| 717SP2213 | 1-3/8" | X | 22" | 17" | REGULAR | \$180.32 |
| 717SP6112 | 1-1/2" | X | 16" | 11" | REGULAR | \$149.32 |
| 717SP4112 | 1-1/2" | X | 22" | 17" | REGULAR | \$169.21 |
| 717SP3234 | 1-3/4" | X | 22" | 17" | REGULAR | \$257.82 |
| 717SP2202 | 2" | X | 22" | 17" | REGULAR | \$290.63 |

X-CUTTER DRILLS REINFORCED CONCRETE!

Spline Drive Rotary Hammer Drills

| Part # | Size | X | OAL | Drilling | Head | List |
|-----------|--------|---|-----|----------|----------|----------|
| 7SPCR1058 | 5/8" | X | 10" | 6" | X-CUTTER | \$58.34 |
| 7SPCR1658 | 5/8" | X | 16" | 11" | X-CUTTER | \$67.78 |
| 7SPCR2258 | 5/8" | X | 22" | 17" | X-CUTTER | \$80.73 |
| 7SPCR2958 | 5/8" | X | 29" | 24" | X-CUTTER | \$111.96 |
| 7SPCR3658 | 5/8" | X | 36" | 31" | X-CUTTER | \$156.18 |
| 7SPCR1034 | 3/4" | X | 10" | 6" | X-CUTTER | \$67.46 |
| 7SPCR1634 | 3/4" | X | 16" | 11" | X-CUTTER | \$72.18 |
| 7SPCR2234 | 3/4" | X | 22" | 17" | X-CUTTER | \$85.46 |
| 7SPCR2934 | 3/4" | X | 29" | 24" | X-CUTTER | \$117.29 |
| 7SPCR3634 | 3/4" | X | 36" | 31" | X-CUTTER | \$162.06 |
| 7SPCR1678 | 7/8" | X | 16" | 11" | X-CUTTER | \$76.66 |
| 7SPCR2278 | 7/8" | X | 22" | 17" | X-CUTTER | \$94.43 |
| 7SPCR1601 | 1" | X | 16" | 11" | X-CUTTER | \$80.73 |
| 7SPCR2201 | 1" | X | 22" | 17" | X-CUTTER | \$101.63 |
| 7SPCR3601 | 1" | X | 36" | 31" | X-CUTTER | \$197.41 |
| 7SPCR1618 | 1-1/8" | X | 16" | 11" | X-CUTTER | \$101.35 |
| 7SPCR2218 | 1-1/8" | X | 22" | 17" | X-CUTTER | \$132.90 |
| 7SPCR1614 | 1-1/4" | X | 16" | 11" | X-CUTTER | \$111.96 |
| 7SPCR2214 | 1-1/4" | X | 22" | 17" | X-CUTTER | \$141.41 |
| 7SPCR3614 | 1-1/4" | X | 36" | 31" | X-CUTTER | \$214.10 |
| 7SPCR2238 | 1-3/8" | X | 22" | 17" | X-CUTTER | \$158.79 |
| 7SPCR2212 | 1-1/2" | X | 22" | 17" | X-CUTTER | \$182.69 |
| 7SPCR3423 | 1-3/4" | X | 23" | 18" | X-CUTTER | \$276.93 |

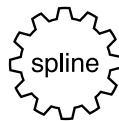

- ◆ Rotary Hammer Drill
- ◆ Industrial Quality
- ◆ 4-Cutter Head
- ◆ Special Tungsten Carbide Tip
- ◆ Copper / Silver Brazing
- ◆ Fastest Dust Removal
- ◆ Fastest Drilling Speeds
- ◆ Heat Treated Body
- ◆ Clean Round Holes
- ◆ Less Vibration
- ◆ Polished Finish
- ◆ ANSI Specification

- Reinforced Concrete
- Brick
- Stone
- Masonry
- Aggregates



SOLD INDIVIDUALLY
1 PER TUBE.



- ◆ Rotary Hammer Drill
- ◆ Industrial Quality
- ◆ 4-Cutter Head
- ◆ Two Large Suction Holes
- ◆ Cleaner and Faster
- ◆ Copper / Silver Brazing
- ◆ Heat Treated Body
- ◆ Clean Round Holes
- ◆ Less Vibration
- ◆ Polished Finish
- ◆ ANSI Specification

- Concrete
- Brick
- Stone
- Masonry
- Aggregates



GERMANY



ANSI

SOLD INDIVIDUALLY.



SDS-Plus Duster Drill Bit

| Part # | Size | X | OAL | Drilling | Head | List |
|---------|--------------------------------------|---|---------|----------|--------|----------|
| EXS-038 | 3/8" | X | 10-1/2" | 6" | DUSTER | \$85.42 |
| EXS-716 | 7/16" | X | 13" | 8" | DUSTER | \$129.80 |
| EXS-012 | 1/2" | X | 13" | 8" | DUSTER | \$133.74 |
| EXS-916 | 9/16" | X | 14" | 9" | DUSTER | \$136.26 |
| EXS-058 | 5/8" | X | 14" | 9" | DUSTER | \$143.41 |
| EXS-034 | 3/4" | X | 14" | 9" | DUSTER | \$153.40 |
| EXS-078 | 7/8" | X | 14" | 9" | DUSTER | \$241.81 |
| EXS-1S | PLASTIC ADAPTER SDS-PLUS REPLACEMENT | | | | | \$34.03 |



SDS-Max Duster Drill Bit

| Part # | Size | X | OAL | Drilling | Head | List |
|---------|-------------------------------------|---|-----|----------|--------|----------|
| EXM-120 | 1/2" | X | 24" | 15-1/2" | DUSTER | \$260.68 |
| EXM-580 | 5/8" | X | 24" | 15-1/2" | DUSTER | \$279.03 |
| EXM-340 | 3/4" | X | 24" | 15-1/2" | DUSTER | \$291.27 |
| EXM-780 | 7/8" | X | 24" | 15-1/2" | DUSTER | \$302.36 |
| EXM-100 | 1" | X | 25" | 17-1/2" | DUSTER | \$323.22 |
| EXM-118 | 1-1/8" | X | 35" | 28" | DUSTER | \$489.91 |
| EXM-138 | 1-3/8" | X | 35" | 28" | DUSTER | \$545.28 |
| EXM-1M | PLASTIC ADAPTER SDS-MAX REPLACEMENT | | | | | \$35.42 |



Attach to Any HEPA Rated Vacuum to Meet OSHA Silica Dust Containment Standards.





Economy Dust Pro (Up to 1")

| Part # | Description | Qty. | List |
|--------|----------------------------|------|--------|
| DP-1 | ECONOMY DUST PRO (PLASTIC) | 1 | \$7.63 |



- ◆ Attach to HEPA Vacuum and Stick to Drilling Surface
- ◆ No Drilling Dust
- ◆ No Need to Clean Holes Before Anchoring



JAPAN

SOLD INDIVIDUALLY.



Sold With One Metal Insert.



Small Dust Pro (Up to 1")

| Part # | Description | Qty. | List |
|--------|----------------|------|---------|
| DP-2 | SMALL DUST PRO | 1 | \$96.83 |



Sold With One Rubber Insert.



Large Dust Pro (Up to 3")

| Part # | Description | Qty. | List |
|--------|----------------|------|----------|
| DP-3 | LARGE DUST PRO | 1 | \$116.28 |



Metal Plate for DP-2



Rubber Plate for DP-3



Replacement Inserts

| Part # | Description | Qty. | List |
|---------|----------------------------|------|---------|
| DP-2-PL | METAL PLATE REPLACEMENT | 1 | \$17.67 |
| DP-3-PL | RUBBER CUT OUT REPLACEMENT | 1 | \$21.75 |

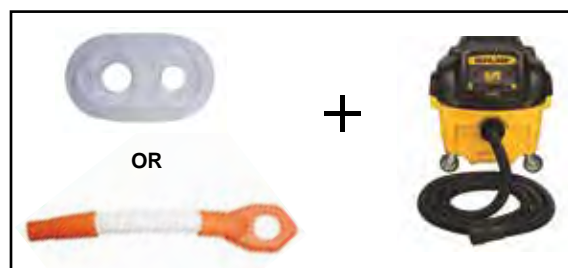

Attach to Any HEPA Rated Vacuum to Meet OSHA Silica Dust Containment Standards.



REBAR PUNCHER NOT SOLD WITH SHANK.



- ◆ Use in Rotary Hammer Action
- ◆ Industrial Quality
- ◆ Tungsten Carbide Teeth
- ◆ Twice the Speed
- ◆ Ratio System



SOLD INDIVIDUALLY. 1 PER TUBE.



Rebar Puncher - ROTARY HAMMER ACTION

| Part # | Size | OAL | RPM | List |
|--------|--------|-----|---------------|----------|
| RG-8 | 1/2" | 9" | HAMMER ACTION | \$101.35 |
| RG-9 | 9/16" | 9" | HAMMER ACTION | \$101.35 |
| RG-10 | 5/8" | 9" | HAMMER ACTION | \$101.35 |
| RG-11 | 11/16" | 9" | HAMMER ACTION | \$102.94 |
| RG-12 | 3/4" | 9" | HAMMER ACTION | \$117.38 |
| RG-14 | 7/8" | 9" | HAMMER ACTION | \$152.22 |
| RG-16 | 1" | 9" | HAMMER ACTION | \$164.76 |
| RG-18 | 1-1/8" | 9" | HAMMER ACTION | \$179.30 |
| RG-20 | 1-1/4" | 9" | HAMMER ACTION | \$200.21 |



Rebar Puncher Shanks

| Part # | Description | OAL | List |
|---------|-------------|--------|---------|
| RG-PLUS | SDS-PLUS | 4" | \$39.42 |
| RG-MAX | SDS-MAX | 7-1/4" | \$78.14 |

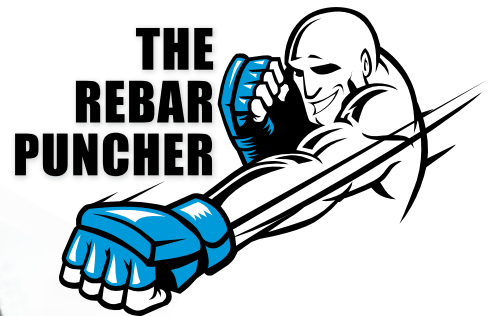

2X SPEED



What to do when you encounter rebar:

- 1 **STOP DRILLING!!!** The sound of a rotary hammer or a carbide hammer drill bit hitting steel is much higher than when cutting concrete.
- 2 Remove the drill bit from the hole.
- 3 Mount a rebar cutter of the same diameter as the hole in an SDS-Plus Hammer Drill with the selector in the "rotary only" position.
- 4 Insert the rebar cutter into the hole and begin drilling at the suggested RPM speed only. Apply just enough pressure to grind away at the rebar. **Do Not Use Excessive Speed or Pressure on the Machine** - this will either damage or break the rebar cutter.
- 5 Once rebar is cut through, remove the rebar cutter from the hole and continue drilling with a rotary hammer or carbide hammer drill bit.

- Carbide cutters are brazed in place to keep Rebar Cutter from enlarging existing hole.

| HEAD SIZES | THREAD |
|-----------------|---------|
| 3/8" → 1-1/2" | 1 pc. |
| 1-3/4" → 2-1/2" | 3/4"-10 |

⚠ REMINDER:

Rebar Cutters are problem solvers only. A 1/2" Rebar Cutter drilling through #6 (3/4") rebar dead center may result in 5 to 10 holes being drilled provided correct speed and pressure are utilized. It is not uncommon for only one piece of rebar to be cut per Rebar Cutter. Rebar Cutters *should not* be used for drilling concrete.

Rebar Cutters are not warrantied for replacement or repair.



Rebar Cutter - SDS-PLUS SHANK

| Part # | Size | OAL | RPM | List |
|--------|--------|-----|----------|----------|
| RBS-6 | 3/8" | 8" | 850-1200 | \$52.55 |
| RBS-8 | 1/2" | 12" | 850-1200 | \$55.00 |
| RBS-9 | 9/16" | 12" | 850-1200 | \$57.46 |
| RBS-10 | 5/8" | 12" | 750-1000 | \$69.74 |
| RBS-11 | 11/16" | 12" | 750-1000 | \$74.65 |
| RBS-12 | 3/4" | 12" | 600-850 | \$77.10 |
| RBS-13 | 13/16" | 12" | 600-850 | \$94.30 |
| RBS-14 | 7/8" | 12" | 600-850 | \$109.20 |
| RBS-16 | 1" | 12" | 500-750 | \$116.40 |
| RBS-18 | 1-1/8" | 12" | 500-750 | \$123.76 |
| RBS-20 | 1-1/4" | 12" | 450-600 | \$131.12 |
| RBS-22 | 1-3/8" | 12" | 450-600 | \$143.41 |
| RBS-24 | 1-1/2" | 12" | 350-500 | \$150.77 |
| RBS-28 | 1-3/4" | 12" | 350-500 | \$172.87 |
| RBS-32 | 2" | 12" | 350-500 | \$241.62 |
| RBS-40 | 2-1/2" | 12" | 350-500 | \$266.18 |



Rotation Only!

SOLD INDIVIDUALLY. 1 PER TUBE.



Rebar Cutter - STRAIGHT SHANK

| Part # | Size | OAL | RPM | List |
|---------|--------|-----|----------|----------|
| RBC0838 | 3/8" | 8" | 850-1200 | \$44.86 |
| RBC1212 | 1/2" | 12" | 850-1200 | \$53.29 |
| RBC1916 | 9/16" | 12" | 850-1200 | \$55.17 |
| RBC1258 | 5/8" | 12" | 750-1000 | \$63.34 |
| RBC1116 | 11/16" | 12" | 750-1000 | \$67.89 |
| RBC1234 | 3/4" | 12" | 600-850 | \$71.96 |
| RBC1834 | 3/4" | 18" | 600-850 | \$92.20 |
| RBC1316 | 13/16" | 12" | 600-850 | \$84.72 |
| RBC1278 | 7/8" | 12" | 600-850 | \$99.67 |
| RBC1201 | 1" | 12" | 500-750 | \$107.15 |
| RBC1218 | 1-1/8" | 12" | 500-750 | \$114.63 |
| RBC1214 | 1-1/4" | 12" | 450-600 | \$122.11 |
| RBC1238 | 1-3/8" | 12" | 450-600 | \$134.57 |
| RBC1112 | 1-1/2" | 12" | 350-500 | \$143.54 |
| RBC1134 | 1-3/4" | 12" | 350-500 | \$185.26 |
| RBC1202 | 2" | 12" | 350-500 | \$279.09 |
| RBC1222 | 2-1/2" | 12" | 350-500 | \$328.93 |



SOLD INDIVIDUALLY. 1 PER TUBE.



Bull Point



Flat Chisel



Scaling Chisel



Angled Chisel



Slotting Chisel



Bushing Tool



Ground Rod Driver



Asphalt Cutter



Seam Tool



Clay Spade



Floor Scraper



Gouge Chisel

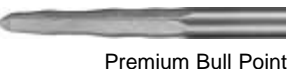

Premium Bull Point



Premium Flat Chisel



round
hex



NOTE: Spline Drive chisels have rounded hex shanks to work effectively in Spline Drive machines made with and without rotation / hammer only switches.



Spline Drive Chisels

| Part # | Size | Description | List |
|--------|-----------------|-------------------|----------|
| 5000BP | 12" | Bull Point | \$18.64 |
| 5005BP | 18" | Bull Point | \$23.08 |
| 5010FC | 1" x 12" | Flat Chisel | \$18.64 |
| 5015FC | 1" x 18" | Flat Chisel | \$23.08 |
| 5020SC | 1-1/2" x 12" | Scaling Chisel | \$27.58 |
| 5025SC | 2" x 12" | Scaling Chisel | \$34.73 |
| 5030SC | 3" x 12" | Scaling Chisel | \$38.37 |
| 5035AC | 2" x 12" | Angled Chisel | \$55.84 |
| 5040SL | 1-1/8" x 12" | Slotting Chisel | \$47.78 |
| 5045BT | 1-7/8" x 9-7/8" | Bushing Tool | \$136.58 |
| 5050GR | 7/8" x 10-1/2" | Ground Rod Driver | \$126.50 |
| 5055PH | 3-1/2" x 16" | Asphalt Cutter | \$162.48 |
| 5060SM | 1-1/8" x 12" | Seam Tool | \$45.57 |
| 5065CS | 5-3/8" x 16" | Clay Spade | \$172.75 |
| 5070FS | 6" x 25" | Floor Scraper | \$485.63 |

SDS-MAX® Chisels

| Part # | Size | Description | List |
|---------|--|-------------------|----------|
| 7000BP | 12" | Bull Point | \$21.41 |
| 7005BP | 18" | Bull Point | \$26.69 |
| 7010FC | 1" x 12" | Flat Chisel | \$21.41 |
| 7015FC | 1" x 18" | Flat Chisel | \$26.69 |
| 7020SC | 1-1/2" x 12" | Scaling Chisel | \$33.23 |
| 7025SC | 2" x 12" | Scaling Chisel | \$34.73 |
| 7028FC | 2" x 16" | Scaling Chisel | \$45.50 |
| 7030SC | 3" x 12" | Scaling Chisel | \$43.51 |
| 7035AC | 2" x 12" | Angled Chisel | \$55.84 |
| 7040SL | 1-1/8" x 12" | Slotting Chisel | \$46.39 |
| 7045BT | 1-7/8" x 9-7/8" | Bushing Tool | \$137.96 |
| 7050GR | 7/8" x 10-1/4" | Ground Rod Driver | \$125.22 |
| 7055PH | 3-1/2" x 16" | Asphalt Cutter | \$167.61 |
| 7060SM | 1-1/8" x 12" | Seam Tool | \$46.59 |
| 7065CS | 5-3/8" x 16" | Clay Spade | \$171.47 |
| 7070FS | 6" x 25" | Floor Scraper | \$485.63 |
| 7075GC | 1" x 12" | Gouge Chisel | \$71.26 |
| FS-6B | Replacement Blade (Floor Scraper) | | \$22.20 |
| FS-6NUT | Replacement Nuts & Bolts (Floor Scraper) | | \$37.99 |

Premium Chisels - 2X the Life

| Part # | Size | Description | Shank | List |
|--------|------------|-------------|----------|---------|
| 9004BP | 16" | Bull Point | SDS-MAX | \$32.11 |
| 9014FC | 1" x 16" | Flat Chisel | SDS-MAX | \$32.11 |
| 9100BP | 10" | Bull Point | SDS-PLUS | \$22.50 |
| 9110FC | 3/4" x 10" | Flat Chisel | SDS-PLUS | \$22.50 |



- ◆ Faster!
- ◆ Less Friction
- ◆ Less Jamming
- ◆ Self Sharpening



SDS-PLUS Chisels

| Part # | Size | Description | List |
|--------|--------------|----------------|---------|
| 3100BP | 10" | Bull Point | \$21.97 |
| 3110FC | 3/4" x 10" | Flat Chisel | \$21.97 |
| 3115SC | 1-1/2" x 10" | Scaling Chisel | \$40.84 |
| 3120GC | 7/8" x 10" | Gouge Chisel | \$39.14 |
| 3125WC | 3/8" x 7" | Wood Chisel | \$39.91 |
| 3130WC | 1/2" x 7" | Wood Chisel | \$42.48 |
| 3140WC | 3/4" x 7" | Wood Chisel | \$46.08 |
| 3150WC | 1" x 7" | Wood Chisel | \$51.73 |
| 3175TC | 3" x 6-1/2" | Tile Chisel | \$41.45 |



Gouge

Wood

Tile

3/4" HEX Chisels - Demolition Hammer

| Part # | Size | Description | List |
|---------|-----------------|-------------------------|----------|
| 6010HEX | 12" | 3/4" Hex Bull Point | \$19.19 |
| 6015HEX | 18" | 3/4" Hex Bull Point | \$24.19 |
| 6020HEX | 1" x 12" | 3/4" Hex Flat Chisel | \$19.19 |
| 6025HEX | 1" x 18" | 3/4" Hex Flat Chisel | \$24.19 |
| 6030HEX | 2" x 12" | 3/4" Hex Scaling Chisel | \$35.80 |
| 6035HEX | 3" x 12" | 3/4" Hex Scaling Chisel | \$41.45 |
| 6040HEX | 3-1/2" x 16" | 3/4" Hex Asphalt Cutter | \$162.48 |
| 6045HEX | 7/8" x 10-1/4" | 3/4" Hex Ground Rod Dr. | \$139.09 |
| 6050HEX | 1-7/8" x 9-7/8" | 3/4" Hex Bushing Tool | \$140.12 |
| 6055HEX | 5-3/8" x 16" | 3/4" Hex Clay Spade | \$173.52 |
| 6060HEX | 6" x 25" | 3/4" Hex Floor Scraper | \$485.63 |

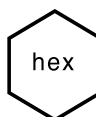

Black & Decker®
5021K

Bosch®
11301 - 11302 -
11305

Milwaukee®
5335

Dewalt®
5021K,
DW558

Hitachi®
H55SC

Makita®
HM1211B



1-1/8" HEX Chisels - Breaker Hammer

| Part # | Size | Description | List |
|---------|--------------|---------------------------|----------|
| 8020HBP | 20" | 1-1/8" Hex Bull Point | \$65.21 |
| 8030HFC | 1-1/4" x 20" | 1-1/8" Hex Flat Chisel | \$66.32 |
| 8040HSC | 3" x 20" | 1-1/8" Hex Scaling Chisel | \$95.74 |
| 8050HPH | 5" x 17" | 1-1/8" Hex Asphalt Cutter | \$215.06 |
| 8060HGR | 1" x 15" | 1-1/8" Hex Ground Rod Dr. | \$158.18 |
| 8070HCS | 5-3/8" x 20" | 1-1/8" Hex Clay Spade | \$219.23 |



Black & Decker®
5027

Bosch®
BRUTE 11304

Milwaukee®
5338

Kango®
2500

Hitachi®
H65 - H85 -
H905SB

Makita®
HM1303B
HM1500B
HM1800

Wacker®
EH27



1-1/8" HEX Shank Chisels come with Internal locks for Demolition Hammers and External Collars for Pneumatic Hammers.

Tamping Plate & Shanks

| Part # | Size | Description | List |
|--------|--------|------------------------|----------|
| 510SPL | 12" | Spline Tamping Shank | \$59.10 |
| 520MAX | 12" | SDS-Max Tamping Shank | \$59.10 |
| 530HEX | 15" | 3/4" Hex Tamping Shank | \$61.89 |
| 550STP | 5" Sq. | Tamping Plate | \$124.10 |





Made In



- ◆ Carbide Teeth
- ◆ Carbide Pilot
- ◆ Ejector Spring
- ◆ 2" Drilling Depth
- ◆ 3-Flat Shank

- Hard Plastic
- Stucco
- Clay Pipe
- Hardy Board
- Dry Lath & Plaster
- Wood with Nails
- Aluminum Siding
- Hard or Composite Plastic

Also Available:

- Extension Shanks
- Replacement Pilots
- Replacement Springs

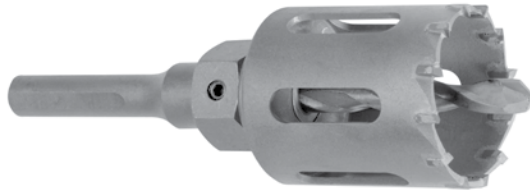

Composite Cutter

| Part # | Size | OAL | Shank | List |
|--------|--------|-----|-------|----------|
| CHS-16 | 1" | 6" | 1/2" | \$178.78 |
| CHS-18 | 1-1/8" | 6" | 1/2" | \$187.03 |
| CHS-20 | 1-1/4" | 6" | 1/2" | \$191.28 |
| CHS-22 | 1-3/8" | 6" | 1/2" | \$195.53 |
| CHS-24 | 1-1/2" | 6" | 1/2" | \$204.02 |
| CHS-26 | 1-5/8" | 6" | 1/2" | \$210.38 |
| CHS-28 | 1-3/4" | 6" | 1/2" | \$216.77 |
| CHS-32 | 2" | 6" | 1/2" | \$233.76 |
| CHS-34 | 2-1/8" | 6" | 1/2" | \$244.41 |
| CHS-36 | 2-1/4" | 6" | 1/2" | \$255.01 |
| CHS-40 | 2-1/2" | 6" | 1/2" | \$267.80 |
| CHS-48 | 3" | 6" | 1/2" | \$297.54 |
| CHS-64 | 4" | 6" | 1/2" | \$365.52 |



Shank Thread

| Diameter | Thread |
|-------------|---------|
| 3/4" & 7/8" | 1/2"-13 |
| 1" → 4" | 3/4"-10 |

Made In



- ◆ Carbide Teeth
- ◆ HSS Pilot
- ◆ Ejector Spring
- ◆ 2" Drilling Depth
- ◆ 3-Flat Shank

- Pipe
- Trench Duct
- Cellular Metal
- Ferrous Metals
- Non-Ferrous Metals
- Ductile Iron Pipe

Also Available:

- Extension Shanks
- Replacement Pilots
- Replacement Springs



Interrupter

| Part # | Size | OAL | Shank | List |
|--------|--------|-----|-------|----------|
| IC-12 | 3/4" | 6" | 3/8" | \$189.13 |
| IC-14 | 7/8" | 6" | 3/8" | \$191.28 |
| IC-16 | 1" | 6" | 1/2" | \$197.63 |
| IC-18 | 1-1/8" | 6" | 1/2" | \$208.27 |
| IC-20 | 1-1/4" | 6" | 1/2" | \$218.91 |
| IC-22 | 1-3/8" | 6" | 1/2" | \$223.16 |
| IC-24 | 1-1/2" | 6" | 1/2" | \$231.66 |
| IC-28 | 1-3/4" | 6" | 1/2" | \$240.16 |
| IC-32 | 2" | 6" | 1/2" | \$267.80 |
| IC-36 | 2-1/4" | 6" | 1/2" | \$278.40 |
| IC-38 | 2-3/8" | 6" | 1/2" | \$289.04 |
| IC-40 | 2-1/2" | 6" | 1/2" | \$297.54 |
| IC-44 | 2-3/4" | 6" | 1/2" | \$323.03 |
| IC-48 | 3" | 6" | 1/2" | \$350.67 |
| IC-52 | 3-1/4" | 6" | 1/2" | \$382.55 |
| IC-56 | 3-1/2" | 6" | 1/2" | \$408.05 |
| IC-60 | 3-3/4" | 6" | 1/2" | \$431.43 |
| IC-64 | 4" | 6" | 1/2" | \$439.93 |

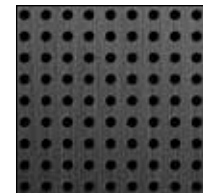
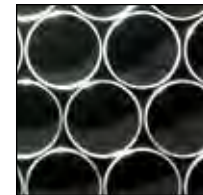



Superdry™ Center Pin

| Part # | Description | List |
|---------|-----------------------------------|----------|
| DRY-CP1 | CENTER PIN - FOR SUPERDRY DIAMOND | \$120.00 |



Superdry™ Diamond Core Bit

| Part # | Size | # Teeth | Drilling | Shank | List |
|----------|---------|---------|----------|-------|-----------|
| DRY-25C | 1" | 6 | 6" | #1 | \$474.54 |
| DRY-29C | 1-1/8" | 7 | 6" | #1 | \$474.54 |
| DRY-32C | 1-1/4" | 8 | 6" | #1 | \$474.54 |
| DRY-35C | 1-3/8" | 8 | 6" | #1 | \$474.54 |
| DRY-38C | 1-1/2" | 9 | 6" | #1 | \$474.54 |
| DRY-45C | 1-3/4" | 9 | 6" | #1 | \$474.54 |
| DRY-50C | 2" | 10 | 6" | #2 | \$496.33 |
| DRY-55C | 2-1/8" | 11 | 6" | #2 | \$496.33 |
| DRY-60C | 2-3/8" | 12 | 6" | #2 | \$518.21 |
| DRY-65C | 2-9/16" | 12 | 6" | #2 | \$545.46 |
| DRY-70C | 2-3/4" | 13 | 6" | #2 | \$578.21 |
| DRY-75C | 2-7/8" | 15 | 6" | #2 | \$638.21 |
| DRY-80C | 3-1/8" | 16 | 6" | #2 | \$698.21 |
| DRY-90C | 3-1/2" | 16 | 6" | #2 | \$790.92 |
| DRY-95C | 3-3/4" | 16 | 6" | #2 | \$872.75 |
| DRY-100C | 3-7/8" | 17 | 6" | #2 | \$927.25 |
| DRY-105C | 4-1/8" | 17 | 6" | #2 | \$981.79 |
| DRY-120C | 4-3/4" | 17 | 6" | #2 | \$1145.46 |
| DRY-130C | 5-1/8" | 18 | 6" | #2 | \$1172.75 |
| DRY-155C | 6" | 22 | 6" | #2 | \$1445.46 |
| DRY-165C | 6-1/2" | 24 | 6" | #2 | \$1500.00 |
| DRY-180C | 7" | 25 | 6" | #2 | \$1612.33 |
| DRY-210C | 8-1/4" | 30 | 6" | #2 | \$1936.33 |

Rotation Only!

- ◆ CLIC System
- ◆ Diamond Teeth
- ◆ Capable of Dry Drilling in Reinforced Concrete
- ◆ Carbide Tipped Center Pin
- ◆ Clean Round Holes
- ◆ Made in Japan



- Reinforced Concrete
- Concrete
- Mortar
- Hume (Culvert) Pipe
- Clay Pipe
- PVC Pipe



Superdry™ SDS-Plus Extension

| Part # | Size | Shank | List |
|-----------|-----------------------------------|-------|----------|
| DRY-S1-8 | 5" EXTENSION (FOR 1" THRU 1-3/4") | #1 | \$99.25 |
| DRY-S1-12 | 8" EXTENSION (FOR 1" THRU 1-3/4") | #1 | \$120.00 |
| DRY-S2-8 | 5" EXTENSION (FOR 2" THRU 8-1/4") | #2 | \$178.46 |
| DRY-S2-12 | 8" EXTENSION (FOR 2" THRU 8-1/4") | #2 | \$213.79 |



Replacement Guide Plates Available.



- ◆ Industrial Quality
- ◆ Quality Diamond Teeth
- ◆ 14" Cutting Depth
- ◆ Use With Water
- ➔ Reinforced Concrete
- ➔ Concrete
- ➔ Brick
- ➔ Stone
- ➔ Masonry
- ➔ Aggregates



USE WATER

SOLD INDIVIDUALLY.
1 PER BOX.



FOR DRILLING
LARGER DIAMETER
HOLES IN
CONCRETE

Diamond Core Bits - Economy

| Part # | Size | X | OAL | # Teeth | Thread | List |
|--------|--------|---|---------|---------|------------|----------|
| DC-01 | 1" | X | 15-3/4" | 3 | 5/8" x 11 | \$62.83 |
| DC-02 | 1-1/4" | X | 15-3/4" | 4 | 5/8" x 11 | \$78.56 |
| DC-03 | 1-3/4" | X | 15-3/4" | 4 | 5/8" x 11 | \$81.72 |
| DC-04 | 2" | X | 15-3/4" | 4 | 1-1/4" x 7 | \$87.00 |
| DC-05 | 2-1/2" | X | 15-3/4" | 6 | 1-1/4" x 7 | \$103.72 |
| DC-06 | 2-3/4" | X | 15-3/4" | 6 | 1-1/4" x 7 | \$112.06 |
| DC-07 | 3" | X | 15-3/4" | 6 | 1-1/4" x 7 | \$114.67 |
| DC-75 | 3-1/2" | X | 15-3/4" | 6 | 1-1/4" x 7 | \$124.22 |
| DC-08 | 4" | X | 15-3/4" | 8 | 1-1/4" x 7 | \$133.00 |
| DC-09 | 4-3/8" | X | 15-3/4" | 9 | 1-1/4" x 7 | \$158.17 |
| DC-95 | 4-1/2" | X | 15-3/4" | 9 | 1-1/4" x 7 | \$171.28 |
| DC-10 | 4-3/4" | X | 15-3/4" | 10 | 1-1/4" x 7 | \$186.50 |
| DC-11 | 5" | X | 15-3/4" | 10 | 1-1/4" x 7 | \$193.11 |
| DC-12 | 6" | X | 15-3/4" | 12 | 1-1/4" x 7 | \$210.56 |
| DC-20 | 8" | X | 15-3/4" | 16 | 1-1/4" x 7 | \$334.17 |

10mm Tall Segments



FOR DRILLING
LARGER DIAMETER
HOLES IN
CONCRETE

Diamond Core Bits - Premium

| Part # | Size | X | OAL | # Teeth | Thread | List |
|--------|--------|---|---------|---------|------------|----------|
| KDX-04 | 2" | X | 15-3/4" | 5 | 1-1/4" x 7 | \$140.00 |
| KDX-05 | 2-1/2" | X | 15-3/4" | 6 | 1-1/4" x 7 | \$151.67 |
| KDX-07 | 3" | X | 15-3/4" | 6 | 1-1/4" x 7 | \$186.67 |
| KDX-08 | 4" | X | 15-3/4" | 8 | 1-1/4" x 7 | \$244.44 |
| KDX-11 | 5" | X | 15-3/4" | 10 | 1-1/4" x 7 | \$330.67 |
| KDX-12 | 6" | X | 15-3/4" | 12 | 1-1/4" x 7 | \$380.44 |
| KDX-20 | 8" | X | 15-3/4" | 16 | 1-1/4" x 7 | \$483.00 |

Step Down Adapter



Hilti BI+ Adapter



Extension



Diamond Core Adapters / Extensions

| Part # | Description | List |
|---------|---|----------|
| ADA001 | ADAPTER STEP DOWN (1-1/4"-7 TO 5/8"-11) | \$76.40 |
| HILA001 | HILTI BI+ TO 5/8"-11 ADAPTER | \$55.10 |
| HILA002 | HILTI BI+ TO 1-1/4"-7 ADAPTER | \$84.58 |
| DCEXT01 | 6" DIAMOND CORE BIT EXTENSION (5/8"-11) | \$130.61 |
| DCEXT02 | 12" DIAMOND CORE BIT EXTENSION (5/8"-11) | \$180.19 |
| DCEXT03 | 6" DIAMOND CORE BIT EXTENSION (1-1/4"-7) | \$178.58 |
| DCEXT04 | 12" DIAMOND CORE BIT EXTENSION (1-1/4"-7) | \$194.03 |



- ◆ Industrial Quality
- ◆ Quality Premium Diamond Teeth
- ◆ 14" Cutting Depth
- ◆ Use With Water

- ➔ Reinforced Concrete
- ➔ Concrete
- ➔ Brick
- ➔ Stone
- ➔ Masonry
- ➔ Aggregates



USE WATER

SOLD INDIVIDUALLY.
1 PER BOX.

2X HOLES

10mm Tall Segments





- ◆ Industrial Quality
- ◆ Quality Premium Diamond Teeth
- ◆ 9" Cutting Depth
- ◆ Dry Drilling
- ◆ 8mm Segments
- ◆ Attack Tooth Geometry

- Concrete
- Cement Block
- Brick
- Masonry
- Pavers



Diamond Core Bits - Dry Drilling

| Part # | Size | X | OAL | # Teeth | Thread | List |
|--------|--------|---|---------|---------|-----------|----------|
| DRX-02 | 1-1/4" | X | 10-3/4" | 3 | 5/8" x 11 | \$91.67 |
| DRX-03 | 1-1/2" | X | 10-3/4" | 3 | 5/8" x 11 | \$108.33 |
| DRX-04 | 2" | X | 10-3/4" | 4 | 5/8" x 11 | \$152.78 |
| DRX-05 | 2-1/2" | X | 10-3/4" | 3 | 5/8" x 11 | \$188.89 |
| DRX-07 | 3" | X | 10-3/4" | 4 | 5/8" x 11 | \$241.67 |

FOR USE WITH A 7" ANGLE GRINDER



1.



2.



3.



Diamond Cutting Wheels

- ◆ Industrial Quality
- ◆ For Dry & Wet Use
- ◆ Individually Blister Carded

- Brick
- Stone
- Masonry
- Aggregates



Diamond Cutting Wheels are great for general contractor work. Each wheel comes with interchangeable adapters for use in virtually all hand-held saws and angle grinders.

4" TUCK POINT DIAMOND CUTTING WHEEL

Part # **TPS40**

List \$66.64

- DRY TYPE
- DIAMETER: 4" ± 0.70MM
- TEETH THICKNESS: 0.25" (-0.00/+0.20MM)
- 28 CRMO Body / LASER WELDED BLADE
- 20MM ROUND ARBOR W/ 5/8" BUSHING ADAPTER (SOLID BRASS)
- 20-25% CONCENTRATION OF DIAMOND GRAIN
- 13,700 RPM MAXIMUM



4-1/2" TUCK POINT DIAMOND CUTTING WHEEL

Part # **TPS45**

List \$77.75

- DRY TYPE
- DIAMETER: 4-1/2" ± 0.70MM
- TEETH THICKNESS: 0.25" (-0.00/+0.20MM)
- 28 CRMO Body / LASER WELDED BLADE
- 20MM ROUND ARBOR W/ 5/8" BUSHING ADAPTER (SOLID BRASS)
- 20-25% CONCENTRATION OF DIAMOND GRAIN
- 13,700 RPM MAXIMUM



4" CONTINUOUS RIM DIAMOND CUTTING WHEEL

Part # **DCR40**

List \$14.58

- DRY & WET TYPE
- DIAMETER: 4" ± 0.70MM
- TEETH THICKNESS: 0.08" (-0.00/+0.20MM)
- 65MN BODY
- 7/8" ROUND ARBOR W/ 20MM & 5/8" BUSHING ADAPTER (SOLID BRASS)
- 20-25% CONCENTRATION OF DIAMOND GRAIN
- 13,700 RPM MAXIMUM





4-1/2" CONTINUOUS RIM DIAMOND CUTTING WHEEL

Part # DCR45

List \$17.36

- DRY & WET TYPE
- DIAMETER: 4-1/2" ± 0.70MM
- TEETH THICKNESS: 0.08" (-0.00/+0.20MM)
- 65MN BODY
- 7/8" ROUND ARBOR W/ 20MM & 5/8" BUSHING ADAPTER (SOLID BRASS)
- 20-25% CONCENTRATION OF DIAMOND GRAIN
- 13,300 RPM MAXIMUM



7" CONTINUOUS RIM DIAMOND CUTTING WHEEL

Part # DCR70

List \$39.58

- DRY & WET TYPE
- DIAMETER: 7" ± 0.70MM
- TEETH THICKNESS: 0.08" (-0.00/+0.20MM)
- 65MN BODY
- 7/8" ROUND ARBOR W/ 20MM & 5/8" BUSHING ADAPTER (SOLID BRASS)
- 20-25% CONCENTRATION OF DIAMOND GRAIN
- 8,400 RPM MAXIMUM

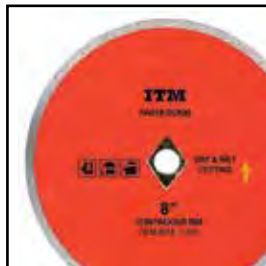

8" CONTINUOUS RIM DIAMOND CUTTING WHEEL

Part # DCR80

List \$42.75

- DRY & WET TYPE
- DIAMETER: 8" ± 0.70MM
- TEETH THICKNESS: 0.1" (-0.00/+0.20MM)
- 65MN BODY
- 7/8" ROUND ARBOR W/ 20MM & 5/8" RHOMBIC BUSHING ADAPTER (SOLID BRASS)
- 20-25% CONCENTRATION OF DIAMOND GRAIN
- 7,400 RPM MAXIMUM



4" TURBO DIAMOND CUTTING WHEEL

Part # DTU40

List \$16.06

- DRY & WET TYPE
- DIAMETER: 4" ± 0.70MM
- TEETH THICKNESS: 0.08" (-0.00/+0.20MM)
- 65MN BODY
- 7/8" ROUND ARBOR W/ 20MM & 5/8" BUSHING ADAPTER (SOLID BRASS)
- 20-25% CONCENTRATION OF DIAMOND GRAIN
- 13,700 RPM MAXIMUM



4-1/2" TURBO DIAMOND CUTTING WHEEL

Part # DTU45

List \$20.18

- DRY & WET TYPE
- DIAMETER: 4-1/2" ± 0.70MM
- TEETH THICKNESS: 0.08" (-0.00/+0.20MM)
- 65MN BODY
- 7/8" ROUND ARBOR W/ 20MM & 5/8" BUSHING ADAPTER (SOLID BRASS)
- 20-25% CONCENTRATION OF DIAMOND GRAIN
- 13,300 RPM MAXIMUM

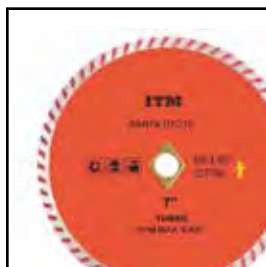

7" TURBO DIAMOND CUTTING WHEEL

Part # DTU70

List \$46.76

- DRY & WET TYPE
- DIAMETER: 7" ± 0.70MM
- TEETH THICKNESS: 0.08" (-0.00/+0.20MM)
- 65MN BODY
- 7/8" ROUND ARBOR W/ 20MM & 5/8" BUSHING ADAPTER (SOLID BRASS)
- 20-25% CONCENTRATION OF DIAMOND GRAIN
- 8,400 RPM MAXIMUM

| 8" TURBO DIAMOND CUTTING WHEEL | |
|--|--|
| Part # DTU80 List \$50.50 | <ul style="list-style-type: none"> • DRY & WET TYPE • DIAMETER: 8" ± 0.70MM • TEETH THICKNESS: 0.1" (-0.00/+0.20MM) • 65MN BODY • 7/8" ROUND ARBOR W/ 20MM & 5/8" RHOMBIC BUSHING ADAPTER (SOLID BRASS) • 20-25% CONCENTRATION OF DIAMOND GRAIN • 7,400 RPM MAXIMUM |

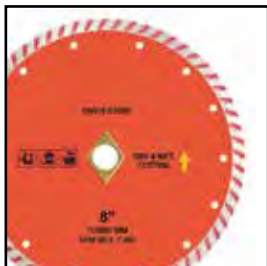

| 4" SEGMENTED DIAMOND CUTTING WHEEL | |
|--|--|
| Part # DCS40 List \$14.58 | <ul style="list-style-type: none"> • DRY TYPE • DIAMETER: 4" ± 0.70MM • TEETH THICKNESS: 0.08" (-0.00/+0.20MM) • 65MN BODY • 7/8" ROUND ARBOR W/ 20MM & 5/8" BUSHING ADAPTER (SOLID BRASS) • 20-25% CONCENTRATION OF DIAMOND GRAIN • 13,700 RPM MAXIMUM |



| 4-1/2" SEGMENTED DIAMOND CUTTING WHEEL | |
|--|--|
| Part # DCS45 List \$17.36 | <ul style="list-style-type: none"> • DRY TYPE • DIAMETER: 4-1/2" ± 0.70MM • TEETH THICKNESS: 0.08" (-0.00/+0.20MM) • 65MN BODY • 7/8" ROUND ARBOR W/ 20MM & 5/8" BUSHING ADAPTER (SOLID BRASS) • 20-25% CONCENTRATION OF DIAMOND GRAIN • 13,300 RPM MAXIMUM |



| 7" SEGMENTED DIAMOND CUTTING WHEEL | |
|--|---|
| Part # DCS70 List \$39.58 | <ul style="list-style-type: none"> • DRY TYPE • DIAMETER: 7" ± 0.70MM • TEETH THICKNESS: 0.08" (-0.00/+0.20MM) • 65MN BODY • 7/8" ROUND ARBOR W/ 20MM & 5/8" BUSHING ADAPTER (SOLID BRASS) • 20-25% CONCENTRATION OF DIAMOND GRAIN • 8,400 RPM MAXIMUM |



| 12" SEGMENTED DIAMOND CUTTING WHEEL | |
|---|--|
| Part # DCS120 List \$76.40 | <ul style="list-style-type: none"> • DRY TYPE • DIAMETER: 12" • TEETH THICKNESS: 0.1" (-0.05/+0.20MM) • TEETH (HIGH): 0.256" (-0.20/+0.70mm) • 65MN BODY • 1" ROUND ARBOR W/ 20MM & 7/8" BUSHING ADAPTER (SOLID BRASS) • 20-25% CONCENTRATION OF DIAMOND GRAIN • 5,000 RPM MAXIMUM |
|  Part # 2DD191S 14MM Brass Ring for 1" Arbor Diamond Wheels List \$3.05 | |



| 14" SEGMENTED DIAMOND CUTTING WHEEL | |
|---|---|
| Part # DCS140 List \$103.32 | <ul style="list-style-type: none"> • DRY TYPE • DIAMETER: 14" • TEETH THICKNESS: 0.12" (-0.05/+0.20MM) • TEETH (HIGH): 0.315" (-0.20/+0.70mm) • 65MN BODY • 1" ROUND ARBOR W/ 20MM & 7/8" BUSHING ADAPTER (SOLID BRASS) • 20-25% CONCENTRATION OF DIAMOND GRAIN • 4,300 RPM MAXIMUM |
|  Part # 2DD191S 14MM Brass Ring for 1" Arbor Diamond Wheels List \$3.05 | |

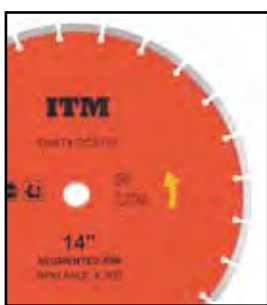



⊕ Phillips

| PHILLIPS POINT # | SHEET METAL SCREWS | WOOD SCREWS | | MACHINE SCREWS | | |
|------------------|------------------------------------|----------------|-------------------|-----------------------|---------------------|--------------------------|
| | FLAT, ROUND, OVAL STOVE BINDING | FLAT, OVAL | ROUND | FLAT, OVAL BINDING | ROUND, FILLISTER | TRUSS, BRAZIER BUTTON |
| 0 | 0, 1 | 0, 1 | 0, 1 | 0, 1 | 0, 1 | 0, 1 |
| 1 | 2, 3, 4 | 2, 3, 4 | 2, 3, 4 | 2, 3, 4 | 2, 3, 4 | 2, 3, 4, 5 |
| 2 | 5, 6, 7, 8, 10 | 5, 6, 7, 8, 9 | 5, 6, 7, 8, 9, 10 | 5, 6, 8, 10 | 5, 6, 8, 10 | 6, 8, 10 |
| 3 | 12, 14 | 10, 12, 14, 16 | 12, 14, 16 | 12, 1/4" | 12, 1/4", 5/16" | 12, 1/4" |

⊖ Slotted

| SLOTTED POINT # | SCREW SIZE | SLOT SCREW WIDTH | | THREAD DIA. | MAXIMUM HEAD DIAMETER | | | | | |
|-----------------|------------|------------------|------|-------------|-----------------------|---------------|-------------------|-----------------|-------------|---------------|
| | | MIN. | MAX. | | FLAT or OVAL HEAD | ROUND HEAD | FILLISTER HEAD | BINDING HEAD | PAN HEAD | TRUSS HEAD |
| 4-5 | 3 | .027 | .035 | .099 | .199 | .187 | .161 | .208 | .193 | .226 |
| 4-5 | 4 | .031 | .039 | .112 | .225 | .211 | .183 | .235 | .219 | .257 |
| 6-8 | 5 | .035 | .043 | .125 | .252 | .236 | .205 | .263 | .245 | .289 |
| 8-10 | 6 | .039 | .048 | .138 | .279 | .260 | .226 | .290 | .270 | .321 |
| 10-12 | 8 | .045 | .054 | .164 | .332 | .309 | .270 | .344 | .322 | .384 |

□ Square

| SQUARE POINT # | TAPPING SCREWS | WOOD SCREWS | MACHINE SCREWS |
|----------------|----------------|-------------|----------------|
| 0 | 3, 4 | 3, 4 | 3, 4 |
| 1 | 5, 6, 7 | 5, 6, 7 | 5, 6 |
| 2 | 8, 10 | 8, 9, 10 | 8, 10 |
| 3 | 12, 14 | 12, 14 | 12, 14 |

☆ Star FOR TORX® SCREWS.

| SCREW SIZE | THREAD DIA. | INTERNAL TORX WASHER HEAD | PAN HEAD | FLAT HEAD | HEX HEAD | TRUSS HEAD | FILLISTER HEAD | OVAL HEAD | SOCKET HEAD CAP | SOCKET SET SCREW |
|------------|-------------|---------------------------|----------|-----------|----------|------------|----------------|-----------|-----------------|------------------|
| 2 | .086 | T7 | T7 | T6 | | | | | | |
| 3 | .099 | T8 | T8 | T7 | | | | | | |
| 4 | .112 | T9 | T9 | T8 | T9 | | T9 | | T10 | T6 |
| 5 | .125 | T10 | T10 | T9 | T10 | | T10 | T10 | T10 | T7 |
| 6 | .138 | T15 | T15 | T10 | T15 | T10 | T15 | T15 | T15 | T7 |
| 8 | .164 | T20 | T20 | T15 | T20 | T15 | T20 | T20 | T25 | T8 |
| 10 | .190 | T25 | T25 | T20 | T25 | T20 | T25 | T25 | T27 | T10 |
| 12 | .216 | T27 | T27 | T25 | T27 | T25 | T27 | T27 | T27 | T10 |
| 1/4" | .250 | T30 | T30 | T27 | T30 | T27 | T30 | T30 | T30 | T20 |
| 5/16" | .312 | | | T40 | T40 | T40 | T340 | T40 | T45 | T27 |
| 3/8" | .375 | | T45 | T40 | T45 | T45 | T45 | T45 | T50 | T30 |
| 7/16" | .437 | | T50 | T50 | | T45 | T50 | T50 | T55 | T40 |
| 1/2" | .500 | | T55 | T50 | | T50 | T55 | T50 | T55 | T45 |



**STAINLESS STEEL
SHAFT**



**1/4" Drive & 5/16" Drive Magnetic Screwdrivers
With Insert Bit Storage Handles. BITS NOT INCLUDED.**

| Part # | Drive | Description | List |
|-----------|-------|----------------------------|---------|
| HH-08-001 | 1/4" | 8" MAGNETIC STORAGE HANDLE | \$13.20 |
| HH-08-002 | 5/16" | 8" MAGNETIC STORAGE HANDLE | \$15.30 |



Insert Bit Countertop Dispenser

| Part # | Type | Qty. | List |
|--------|---------------|------|----------|
| BITDIS | EMPTY DISPLAY | 1 | \$275.00 |

- ◆ Sold Empty
- ◆ Make Your Own Assortment
- ◆ Display Made In Canada



KEEP YOUR INSERT BITS AND NUT SETTERS SAFE AND ORGANIZED.





Phillips® Insert Bits - 1/4" Hex Shank

| Part # | Size | OAL | Type | Qty. | List |
|-----------|---------|-----|-----------------|------|--------|
| T3-025-00 | #0 X 1" | | PHILLIPS INSERT | 25 | \$0.75 |
| T3-025-01 | #1 X 1" | | PHILLIPS INSERT | 25 | \$0.50 |
| T3-025-02 | #2 X 1" | | PHILLIPS INSERT | 25 | \$0.45 |
| T3-025-03 | #3 X 1" | | PHILLIPS INSERT | 25 | \$0.45 |
| T3-025-04 | #4 X 1" | | PHILLIPS INSERT | 25 | \$3.25 |



Reduced Body

Phillips® Drywall Bits - 1/4" Hex Shank

| Part # | Size | OAL | Type | Qty. | List |
|-----------|---------|-----|------------------|------|--------|
| T3-025-1W | #1 X 1" | | PHILLIPS DRYWALL | 25 | \$0.50 |
| T3-025-2W | #2 X 1" | | PHILLIPS DRYWALL | 25 | \$0.50 |



Phillips® Insert Bits - 5/16" Hex Shank

| Part # | Size | OAL | Type | Qty. | List |
|-----------|-------------|-----|-----------------|------|--------|
| T3-032-01 | #1 X 1-1/4" | | PHILLIPS INSERT | 25 | \$0.95 |
| T3-032-02 | #2 X 1-1/4" | | PHILLIPS INSERT | 25 | \$0.95 |
| T3-032-03 | #3 X 1-1/4" | | PHILLIPS INSERT | 25 | \$0.95 |



Phillips® Stopper - 1/4" Hex Shank

| Part # | Size | OAL | Type | Qty. | List |
|-----------|---------|-----|------------------|------|--------|
| SP-025-2P | #2 X 1" | | PHILLIPS STOPPER | 25 | \$1.75 |



Phillips® ACR® Insert Bits - 1/4" Hex

| Part # | Size | OAL | Type | Qty. | List |
|------------|---------|-----|---------------------|------|--------|
| ACR-025-01 | #1 X 1" | | PHILLIPS ACR INSERT | 25 | \$0.55 |
| ACR-025-02 | #2 X 1" | | PHILLIPS ACR INSERT | 25 | \$0.55 |
| ACR-025-03 | #3 X 1" | | PHILLIPS ACR INSERT | 25 | \$0.55 |



Phillips® Power Bits - 1/4" Hex Shank

| Part # | Size | OAL | Type | Qty. | List |
|-----------|-------------|-----|----------------|------|--------|
| T3-050-01 | #1 X 2" | | PHILLIPS POWER | 25 | \$0.75 |
| T3-070-01 | #1 X 2-3/4" | | PHILLIPS POWER | 25 | \$1.25 |
| T3-075-01 | #1 X 3" | | PHILLIPS POWER | 25 | \$1.35 |
| T3-090-01 | #1 X 3-1/2" | | PHILLIPS POWER | 25 | \$1.55 |
| T3-100-01 | #1 X 4" | | PHILLIPS POWER | 25 | \$1.85 |
| T3-125-01 | #1 X 5" | | PHILLIPS POWER | 25 | \$2.55 |
| T3-150-01 | #1 X 6" | | PHILLIPS POWER | 25 | \$3.25 |
| T3-050-02 | #2 X 2" | | PHILLIPS POWER | 25 | \$0.75 |
| T3-070-02 | #2 X 2-3/4" | | PHILLIPS POWER | 25 | \$1.25 |
| T3-075-02 | #2 X 3" | | PHILLIPS POWER | 25 | \$1.35 |
| T3-090-02 | #2 X 3-1/2" | | PHILLIPS POWER | 25 | \$1.55 |
| T3-100-02 | #2 X 4" | | PHILLIPS POWER | 25 | \$1.85 |
| T3-125-02 | #2 X 5" | | PHILLIPS POWER | 25 | \$2.55 |
| T3-150-02 | #2 X 6" | | PHILLIPS POWER | 25 | \$3.25 |
| T3-050-03 | #3 X 2" | | PHILLIPS POWER | 25 | \$0.75 |
| T3-070-03 | #3 X 2-3/4" | | PHILLIPS POWER | 25 | \$1.25 |
| T3-075-03 | #3 X 3" | | PHILLIPS POWER | 25 | \$1.35 |
| T3-090-03 | #3 X 3-1/2" | | PHILLIPS POWER | 25 | \$1.55 |
| T3-100-03 | #3 X 4" | | PHILLIPS POWER | 25 | \$1.85 |
| T3-125-03 | #3 X 5" | | PHILLIPS POWER | 25 | \$2.55 |
| T3-150-03 | #3 X 6" | | PHILLIPS POWER | 25 | \$3.25 |



Reduced Body

Phillips® Drywall Bits

| Part # | Size | OAL | Type | Qty. | List |
|-----------|-------------|-----|------------------|------|--------|
| T3-050-2W | #2 X 2" | | PHILLIPS DRYWALL | 25 | \$0.85 |
| T3-070-2W | #2 X 2-3/4" | | PHILLIPS DRYWALL | 25 | \$1.35 |
| T3-090-2W | #2 X 3-1/2" | | PHILLIPS DRYWALL | 25 | \$2.15 |



Phillips® ACR® Power Bits - 1/4" Hex

| Part # | Size | OAL | Type | Qty. | List |
|------------|---------|-----|--------------------|------|--------|
| ACR-050-01 | #1 X 2" | | PHILLIPS ACR POWER | 25 | \$0.95 |
| ACR-050-02 | #2 X 2" | | PHILLIPS ACR POWER | 25 | \$0.95 |
| ACR-050-03 | #3 X 2" | | PHILLIPS ACR POWER | 25 | \$0.95 |



For Torx® Screws

Star Insert Bits - 1/4" Hex Shank

| Part # | Size | OAL | Type | Qty. | List |
|-----------|-------|-----|-------------|------|--------|
| TX-025-06 | T6 X | 1" | STAR INSERT | 25 | \$0.65 |
| TX-025-07 | T7 X | 1" | STAR INSERT | 25 | \$0.65 |
| TX-025-08 | T8 X | 1" | STAR INSERT | 25 | \$0.65 |
| TX-025-09 | T9 X | 1" | STAR INSERT | 25 | \$0.65 |
| TX-025-10 | T10 X | 1" | STAR INSERT | 25 | \$0.65 |
| TX-025-15 | T15 X | 1" | STAR INSERT | 25 | \$0.65 |
| TX-025-20 | T20 X | 1" | STAR INSERT | 25 | \$0.65 |
| TX-025-25 | T25 X | 1" | STAR INSERT | 25 | \$0.65 |
| TX-025-27 | T27 X | 1" | STAR INSERT | 25 | \$0.65 |
| TX-025-30 | T30 X | 1" | STAR INSERT | 25 | \$0.65 |
| TX-025-40 | T40 X | 1" | STAR INSERT | 25 | \$0.65 |



Square Insert Bits - 1/4" Hex Shank

| Part # | Size | OAL | Type | Qty. | List |
|-----------|------|-----|---------------|------|--------|
| T3-R25-00 | #0 X | 1" | SQUARE INSERT | 25 | \$0.65 |
| T3-R25-01 | #1 X | 1" | SQUARE INSERT | 25 | \$0.58 |
| T3-R25-02 | #2 X | 1" | SQUARE INSERT | 25 | \$0.58 |
| T3-R25-03 | #3 X | 1" | SQUARE INSERT | 25 | \$0.58 |



For Torx® Screws

Star Power Bits - 5/16" Hex Shank

| Part # | Size | OAL | Type | Qty. | List |
|-----------|-------|--------|------------|------|--------|
| TX-032-30 | T30 X | 1-1/4" | STAR POWER | 25 | \$1.55 |
| TX-032-40 | T40 X | 1-1/4" | STAR POWER | 25 | \$1.55 |
| TX-032-45 | T45 X | 1-1/4" | STAR POWER | 25 | \$1.55 |
| TX-032-50 | T50 X | 1-1/4" | STAR POWER | 25 | \$1.55 |
| TX-032-55 | T55 X | 1-1/4" | STAR POWER | 25 | \$1.55 |



Square Power Bits - 1/4" Hex Shank

| Part # | Size | OAL | Type | Qty. | List |
|-----------|------|--------|--------------|------|--------|
| T3-R50-01 | #1 X | 2" | SQUARE POWER | 25 | \$1.45 |
| T3-R70-01 | #1 X | 2-3/4" | SQUARE POWER | 25 | \$1.60 |
| T3-R75-01 | #1 X | 3" | SQUARE POWER | 25 | \$1.85 |
| T3-R90-01 | #1 X | 3-1/2" | SQUARE POWER | 25 | \$2.05 |
| T3-R10-01 | #1 X | 4" | SQUARE POWER | 25 | \$2.15 |
| T3-R12-01 | #1 X | 5" | SQUARE POWER | 25 | \$2.75 |
| T3-R15-01 | #1 X | 6" | SQUARE POWER | 25 | \$3.75 |
| T3-R50-02 | #2 X | 2" | SQUARE POWER | 25 | \$1.45 |
| T3-R70-02 | #2 X | 2-3/4" | SQUARE POWER | 25 | \$1.60 |
| T3-R75-02 | #2 X | 3" | SQUARE POWER | 25 | \$1.85 |
| T3-R90-02 | #2 X | 3-1/2" | SQUARE POWER | 25 | \$2.05 |
| T3-R10-02 | #2 X | 4" | SQUARE POWER | 25 | \$2.15 |
| T3-R12-02 | #2 X | 5" | SQUARE POWER | 25 | \$2.75 |
| T3-R15-02 | #2 X | 6" | SQUARE POWER | 25 | \$3.75 |
| T3-R50-03 | #3 X | 2" | SQUARE POWER | 25 | \$1.45 |
| T3-R70-03 | #3 X | 2-3/4" | SQUARE POWER | 25 | \$1.60 |
| T3-R75-03 | #3 X | 3" | SQUARE POWER | 25 | \$1.85 |
| T3-R90-03 | #3 X | 3-1/2" | SQUARE POWER | 25 | \$2.05 |
| T3-R10-03 | #3 X | 4" | SQUARE POWER | 25 | \$2.15 |
| T3-R12-03 | #3 X | 5" | SQUARE POWER | 25 | \$2.75 |
| T3-R15-03 | #3 X | 6" | SQUARE POWER | 25 | \$3.75 |



For Torx® Screws

Star Power Bits - 1/4" Hex Shank

| Part # | Size | OAL | Type | Qty. | List |
|-----------|-------|-----|------------|------|--------|
| TX-050-10 | T10 X | 2" | STAR POWER | 25 | \$0.85 |
| TX-150-10 | T10 X | 6" | STAR POWER | 25 | \$7.45 |
| TX-050-15 | T15 X | 2" | STAR POWER | 25 | \$0.85 |
| TX-150-15 | T15 X | 6" | STAR POWER | 25 | \$7.45 |
| TX-050-20 | T20 X | 2" | STAR POWER | 25 | \$0.85 |
| TX-150-20 | T20 X | 6" | STAR POWER | 25 | \$7.45 |
| TX-050-25 | T25 X | 2" | STAR POWER | 25 | \$0.85 |
| TX-150-25 | T25 X | 6" | STAR POWER | 25 | \$7.45 |
| TX-050-27 | T27 X | 2" | STAR POWER | 25 | \$0.85 |
| TX-150-27 | T27 X | 6" | STAR POWER | 25 | \$7.45 |
| TX-050-30 | T30 X | 2" | STAR POWER | 25 | \$0.85 |
| TX-150-30 | T30 X | 6" | STAR POWER | 25 | \$7.45 |
| TX-050-40 | T40 X | 2" | STAR POWER | 25 | \$0.85 |
| TX-150-40 | T40 X | 6" | STAR POWER | 25 | \$7.45 |



- ◆ S2 Modified Steel
- ◆ Rc. 58-62 Heat Treated
- ◆ German Grade Steel



Pozidriv® Insert Bits - 1/4" Hex Shank

| Part # | Size | OAL | Type | Qty. | List |
|-----------|---------|-----|-----------------|------|--------|
| PZ-025-01 | #1 X 1" | | POZIDRIV INSERT | 25 | \$0.90 |
| PZ-025-02 | #2 X 1" | | POZIDRIV INSERT | 25 | \$0.90 |
| PZ-025-03 | #3 X 1" | | POZIDRIV INSERT | 25 | \$0.90 |



Pozidriv® Power Bits - 1/4" Hex Shank

| Part # | Size | OAL | Type | Qty. | List |
|-----------|---------|-----|----------------|------|--------|
| PZ-050-01 | #1 X 2" | | POZIDRIV POWER | 25 | \$1.40 |
| PZ-050-02 | #2 X 2" | | POZIDRIV POWER | 25 | \$1.40 |
| PZ-075-02 | #2 X 3" | | POZIDRIV POWER | 25 | \$1.90 |
| PZ-050-03 | #3 X 2" | | POZIDRIV POWER | 25 | \$1.40 |



Slotted Insert Bits - 1/4" Hex Shank

| Part # | Size | OAL | Type | Qty. | List |
|-----------|-------------|-----|----------------|------|--------|
| ST-025-04 | #4-5 X 1" | | SLOTTED INSERT | 25 | \$0.56 |
| ST-025-08 | #6-8 X 1" | | SLOTTED INSERT | 25 | \$0.56 |
| ST-025-10 | #8-10 X 1" | | SLOTTED INSERT | 25 | \$0.56 |
| ST-025-12 | #10-12 X 1" | | SLOTTED INSERT | 25 | \$0.56 |



Slotted Power Bits - 1/4" Hex Shank

| Part # | Size | OAL | Type | Qty. | List |
|-----------|----------------|-----|---------------|------|--------|
| ST-050-04 | #4-5 X 2" | | SLOTTED POWER | 25 | \$0.98 |
| ST-050-08 | #6-8 X 2" | | SLOTTED POWER | 25 | \$0.98 |
| ST-050-10 | #8-10 X 2" | | SLOTTED POWER | 25 | \$0.98 |
| ST-070-10 | #8-10 X 3" | | SLOTTED POWER | 25 | \$1.48 |
| ST-090-10 | #8-10 X 3-1/2" | | SLOTTED POWER | 25 | \$1.65 |
| ST-050-12 | #10-12 X 2" | | SLOTTED POWER | 25 | \$0.98 |



Hex Insert Bits - 1/4" Hex Shank

| Part # | Size | OAL | Type | Qty. | List |
|-----------|------------|-----|------------|------|--------|
| HE-25-564 | 5/64" X 1" | | HEX INSERT | 25 | \$0.80 |
| HE-25-332 | 3/32" X 1" | | HEX INSERT | 25 | \$0.80 |
| HE-25-764 | 7/64" X 1" | | HEX INSERT | 25 | \$0.80 |
| HE-25-864 | 1/8" X 1" | | HEX INSERT | 25 | \$0.80 |
| HE-25-532 | 5/32" X 1" | | HEX INSERT | 25 | \$0.80 |
| HE-25-316 | 3/16" X 1" | | HEX INSERT | 25 | \$0.80 |



Hex Insert Bits - 5/16" Hex Shank

| Part # | Size | OAL | Type | Qty. | List |
|-----------|----------------|-----|------------|------|--------|
| HE-32-316 | 3/16" X 1-1/4" | | HEX INSERT | 25 | \$1.46 |
| HE-32-732 | 7/32" X 1-1/4" | | HEX INSERT | 25 | \$1.46 |
| HE-32-014 | 1/4" X 1-1/4" | | HEX INSERT | 25 | \$1.46 |



Double End Bits - 1/4" Hex Shank

| Part # | Size | Qty. | List |
|-----------|-----------------------------|------|--------|
| DW-050-22 | #2 PHILLIPS / #2 PHILLIPS | 25 | \$1.52 |
| DW-050-26 | #2 PHILLIPS / #6-8 SLOTTED | 25 | \$1.52 |
| DW-050-28 | #2 PHILLIPS / #8-10 SLOTTED | 25 | \$1.52 |



- ◆ S2 Modified Steel
- ◆ Rc. 58-62 Heat Treated
- ◆ German Grade Steel



Spanner Insert Bits - 1/4" Hex Shank

| Part # | Size | OAL | Type | Qty. | List |
|-----------|----------|-----|---------|------|--------|
| SP-025-06 | #6 X 1" | | SPANNER | 25 | \$1.75 |
| SP-025-08 | #8 X 1" | | SPANNER | 25 | \$1.75 |
| SP-025-10 | #10 X 1" | | SPANNER | 25 | \$1.75 |
| SP-025-12 | #12 X 1" | | SPANNER | 25 | \$1.75 |
| SP-025-14 | #14 X 1" | | SPANNER | 25 | \$1.75 |



Hex Tamper Insert Bits - 1/4" Hex

| Part # | Size | OAL | Type | Qty. | List |
|-----------|------------|-----|------------|------|--------|
| TH-25-332 | 3/32" X 1" | | HEX TAMPER | 25 | \$1.55 |
| TH-25-018 | 1/8" X 1" | | HEX TAMPER | 25 | \$1.55 |
| TH-25-964 | 9/64" X 1" | | HEX TAMPER | 25 | \$1.55 |
| TH-25-532 | 5/32" X 1" | | HEX TAMPER | 25 | \$1.55 |
| TH-25-316 | 3/16" X 1" | | HEX TAMPER | 25 | \$1.55 |
| TH-25-732 | 7/32" X 1" | | HEX TAMPER | 25 | \$1.55 |
| TH-25-014 | 1/4" X 1" | | HEX TAMPER | 25 | \$1.55 |
| TH-25-516 | 5/16" X 1" | | HEX TAMPER | 25 | \$1.55 |



For TAMPER RESISTANT Torx® Screws

Star Tamper Insert Bits - 1/4" Hex

| Part # | Size | OAL | Type | Qty. | List |
|-----------|----------|-----|-------------|------|--------|
| TT-025-08 | T8 X 1" | | STAR TAMPER | 25 | \$1.45 |
| TT-025-09 | T9 X 1" | | STAR TAMPER | 25 | \$1.45 |
| TT-025-10 | T10 X 1" | | STAR TAMPER | 25 | \$1.45 |
| TT-025-15 | T15 X 1" | | STAR TAMPER | 25 | \$1.45 |
| TT-025-20 | T20 X 1" | | STAR TAMPER | 25 | \$1.45 |
| TT-025-25 | T25 X 1" | | STAR TAMPER | 25 | \$1.45 |
| TT-025-27 | T27 X 1" | | STAR TAMPER | 25 | \$1.45 |
| TT-025-30 | T30 X 1" | | STAR TAMPER | 25 | \$1.45 |
| TT-025-40 | T40 X 1" | | STAR TAMPER | 25 | \$1.45 |



Tri-Wing® Tamper Insert Bits - 1/4" Hex

| Part # | Size | OAL | Type | Qty. | List |
|-----------|---------|-----|----------|------|--------|
| TRI-25-01 | #1 X 1" | | TRI-WING | 25 | \$1.68 |
| TRI-25-02 | #2 X 1" | | TRI-WING | 25 | \$1.68 |
| TRI-25-03 | #3 X 1" | | TRI-WING | 25 | \$1.68 |

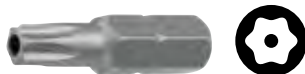

For TAMPER RESISTANT Torx® Screws

Star Tamper Insert Bits - 5/16" Hex

| Part # | Size | OAL | Type | Qty. | List |
|-----------|--------------|-----|-------------|------|--------|
| TT-032-45 | T45 X 1-1/4" | | STAR TAMPER | 25 | \$2.80 |
| TT-032-50 | T50 X 1-1/4" | | STAR TAMPER | 25 | \$2.80 |
| TT-032-55 | T55 X 1-1/4" | | STAR TAMPER | 25 | \$2.80 |



Phillips® Tamper Insert Bits - 1/4" Hex

| Part # | Size | OAL | Type | Qty. | List |
|-----------|---------|-----|-----------------|------|--------|
| TP-025-02 | #2 X 1" | | PHILLIPS TAMPER | 25 | \$2.75 |
| TP-025-03 | #3 X 1" | | PHILLIPS TAMPER | 25 | \$2.75 |



- ◆ S2 Modified Steel
- ◆ Rc. 58-62 Heat Treated
- ◆ German Grade Steel

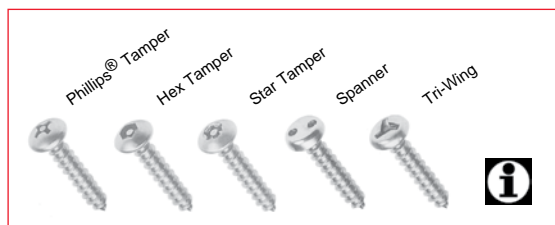



Bit Holders - Stainless Steel - Magnetic



| Part # | OAL | Body Dia. | Retaining Ring | Description | List |
|-----------|--------|-----------|----------------|-------------------|--------|
| BH-020-RC | 1-3/4" | 7/16" | NO | 2PC. CONSTRUCTION | \$5.33 |



| Part # | OAL | Body Dia. | Retaining Ring | Description | List |
|-----------|----------|-----------|----------------|-------------------|--------|
| BH-040-RC | 1-13/16" | 7/16" | YES | 1PC. CONSTRUCTION | \$5.65 |



| Part # | OAL | Body Dia. | Retaining Ring | Description | List |
|-----------|--------|-----------|----------------|-------------------|--------|
| BH-060-RC | 2-5/8" | 7/16" | YES | 1PC. CONSTRUCTION | \$4.75 |

BH-060-40 made of Chrome Vanadium.



| Part # | OAL | Body Dia. | Retaining Ring | Description | List |
|-----------|--------|-----------|----------------|-------------------|--------|
| BH-060-40 | 2-5/8" | 3/8" | NO | 2PC. CONSTRUCTION | \$3.21 |



| Part # | OAL | Body Dia. | Retaining Ring | Description | List |
|-----------|-----|-----------|----------------|-------------------|--------|
| BH-075-14 | 3" | 7/16" | NO | 2PC. CONSTRUCTION | \$4.77 |



| Part # | OAL | Body Dia. | Retaining Ring | Description | List |
|------------|-----|-----------|----------------|-------------------|--------|
| BH-075-14R | 3" | 7/16" | YES | 2PC. CONSTRUCTION | \$5.00 |



| Part # | OAL | Body Dia. | Retaining Ring | Description | List |
|-----------|-----|-----------|----------------|-------------------|--------|
| BH-075-RC | 3" | 7/16" | YES | 1PC. CONSTRUCTION | \$5.35 |



| Part # | OAL | Body Dia. | Retaining Ring | Description | List |
|-----------|-----|-----------|----------------|-------------------|---------|
| BH-100-TR | 3" | 7/16" | THREADED | 1PC. CONSTRUCTION | \$10.80 |



| Part # | OAL | Body Dia. | Retaining Ring | Description | List |
|-----------|-----|-----------|----------------|-------------------|--------|
| BH-100-RC | 4" | 7/16" | YES | 1PC. CONSTRUCTION | \$8.83 |



| Part # | OAL | Body Dia. | Retaining Ring | Description | List |
|-----------|-----|-----------|----------------|-------------------|---------|
| BH-150-RC | 6" | 7/16" | YES | 1PC. CONSTRUCTION | \$16.93 |

Bit Holders - Special Application - Magnetic

| Part # | OAL | Body Dia. | Retaining Ring | Description | List |
|-----------|-----|-----------|----------------|------------------|--------|
| BH-050-LK | 2" | 9/16" | YES / LOCK | SNAP LOCK HOLDER | \$7.18 |
| BH-075-LK | 3" | 9/16" | YES / LOCK | SNAP LOCK HOLDER | \$9.63 |



Pull back system locks in bits.

| Part # | OAL | Body Dia. | Retaining Ring | Description | List |
|-----------|-----|-----------|----------------|---------------------|--------|
| BH-075-SL | 3" | 7/16" | NO | SLEEVE GUIDE HOLDER | \$5.72 |
| BH-125-SL | 5" | 7/16" | NO | SLEEVE GUIDE HOLDER | \$6.05 |



Sleeve extends up to 8" (on 5" length sleeve guide) to hold screw while fasteneing.

| Part # | OAL | Body Dia. | Retaining Ring | Description | List |
|-----------|--------|-----------|----------------|---------------------|---------|
| FX-075-01 | 7-1/4" | 1/2" | YES / BALL | FLEXIBLE BIT HOLDER | \$13.75 |



Flexible shaft can bend up to 90° for those hard to reach areas.

| Part # | OAL | Body Dia. | Retaining Ring | Description | List |
|---------|--------|-----------|----------------|------------------|--------|
| QUI0001 | 1-3/4" | 13/16" | LOCK | METAL/SPRING OUT | \$6.25 |



Chucks have a quick insert / quick spring out system for easy bit changing. Locks in bits. Use with 2"+ POWER bits only!!!

| Part # | OAL | Body Dia. | Retaining Ring | Description | List |
|-----------|-----|-----------|----------------|---------------|--------|
| DC-075-01 | 3" | 9/16" | LOCK | POWER STOPPER | \$9.95 |



Use with any 1" bit tips. Adjustable depth prevents over-driving screws into material. Magnetic.

Lag Driver / Ceiling Tile Hanger Driver

| Part # | Size | Type | Qty. | List |
|-------------|-----------------|------------------------|------|--------|
| CE-075-14SL | 7/16" X 2-3/16" | LAG DRIVER WITH SLEEVE | 10 | \$3.95 |





1/4"
DRIVE

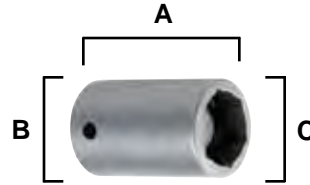

1/4" Square Drive Extension

| Part # | OAL | List |
|-----------|--------|--------|
| AD-025-14 | 1" | \$2.88 |
| AD-032-14 | 1-1/4" | \$4.22 |
| AD-050-14 | 2" | \$4.25 |
| AD-075-14 | 3" | \$4.66 |
| AD-100-14 | 4" | \$5.90 |
| AD-150-14 | 5" | \$7.42 |
| AD-200-14 | 6" | \$9.09 |

1/4" Square Drive Impact Sockets

| Part # | Hex Size | Length (A) | Body (B) | Nose (C) | List |
|-----------|----------|------------|----------|----------|--------|
| 250ST1264 | 3/16" | 15/16" | 1/2" | 3/8" | \$6.60 |
| 250ST1664 | 1/4" | 15/16" | 1/2" | 7/16" | \$6.89 |
| 250ST2064 | 5/16" | 15/16" | 1/2" | 1/2" | \$7.66 |
| 250ST2464 | 3/8" | 1" | 5/8" | 9/16" | \$7.89 |
| 250ST3264 | 1/2" | 1" | 3/4" | 3/4" | \$9.59 |



3/8"
DRIVE

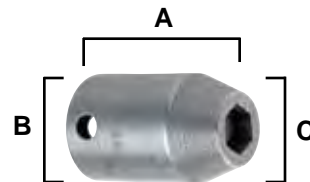

3/8" Square Drive Extension

| Part # | OAL | List |
|-----------|-----|---------|
| AD-050-38 | 2" | \$6.01 |
| AD-075-38 | 3" | \$6.45 |
| AD-100-38 | 4" | \$8.95 |
| AD-150-38 | 6" | \$11.00 |
| AD-200-38 | 8" | \$16.25 |

3/8" Square Drive Impact Sockets

| Part # | Hex Size | Length (A) | Body (B) | Nose (C) | List |
|-----------|----------|------------|----------|----------|---------|
| 375ST1664 | 1/4" | 1-1/4" | 3/4" | 7/16" | \$7.74 |
| 375ST2064 | 5/16" | 1-1/4" | 3/4" | 1/2" | \$7.74 |
| 375ST2464 | 3/8" | 1-1/4" | 3/4" | 9/16" | \$8.65 |
| 375ST3264 | 1/2" | 1-1/2" | 15/16" | 3/4" | \$11.73 |



1/2"
DRIVE

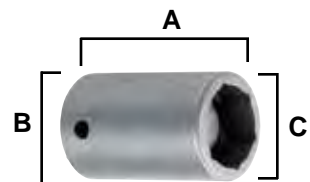

1/2" Square Drive Extension

| Part # | OAL | List |
|-----------|--------|---------|
| AD-055-12 | 2-1/8" | \$7.13 |
| AD-075-12 | 3" | \$8.69 |
| AD-150-12 | 6" | \$12.39 |
| AD-200-12 | 8" | \$16.48 |

1/2" Square Drive Impact Sockets

| Part # | Hex Size | Length (A) | Body (B) | Nose (C) | List |
|-----------|----------|------------|----------|----------|---------|
| 500ST1664 | 1/4" | 1-1/2" | 15/16" | 7/16" | \$9.59 |
| 500ST2064 | 5/16" | 1-1/2" | 15/16" | 1/2" | \$9.03 |
| 500ST2464 | 3/8" | 1-1/2" | 15/16" | 9/16" | \$9.24 |
| 500ST3264 | 1/2" | 1-1/2" | 15/16" | 3/4" | \$10.15 |

Nut Setters - Magnetic Impact Protection

| Part # | Hex Head Size | X | OAL | Type | Qty. | List |
|------------|---------------|---|---------|-------------|------|---------|
| IMP-042-16 | 1/4" | X | 1-3/4" | MAG. IMPACT | 10 | \$3.60 |
| IMP-065-16 | 1/4" | X | 2-9/16" | MAG. IMPACT | 10 | \$4.31 |
| IMP-075-16 | 1/4" | X | 4" | MAG. IMPACT | 5 | \$10.01 |
| IMP-085-16 | 1/4" | X | 6" | MAG. IMPACT | 5 | \$13.60 |
| IMP-042-20 | 5/16" | X | 1-3/4" | MAG. IMPACT | 10 | \$4.03 |
| IMP-065-20 | 5/16" | X | 2-9/16" | MAG. IMPACT | 10 | \$5.69 |
| IMP-075-20 | 5/16" | X | 4" | MAG. IMPACT | 5 | \$12.01 |
| IMP-085-20 | 5/16" | X | 6" | MAG. IMPACT | 5 | \$18.16 |
| IMP-042-24 | 3/8" | X | 1-3/4" | MAG. IMPACT | 10 | \$4.58 |
| IMP-065-24 | 3/8" | X | 2-9/16" | MAG. IMPACT | 10 | \$6.81 |
| IMP-075-24 | 3/8" | X | 4" | MAG. IMPACT | 5 | \$13.77 |
| IMP-085-24 | 3/8" | X | 6" | MAG. IMPACT | 5 | \$22.98 |
| IMP-085-40 | 9/16" | X | 6" | MAG. IMPACT | 5 | \$25.27 |

Nut Setters - Magnetic (Standard)

| Part # | Hex Head Size | X | OAL | Type | Qty. | List |
|-----------|---------------|---|---------|-----------------|------|---------|
| NS-042-16 | 1/4" | X | 1-3/4" | MAG. NUT SETTER | 10 | \$2.40 |
| NS-053-16 | 1/4" | X | 2-1/8" | MAG. NUT SETTER | 10 | \$2.75 |
| NS-065-16 | 1/4" | X | 2-9/16" | MAG. NUT SETTER | 10 | \$2.89 |
| NS-075-16 | 1/4" | X | 4" | MAG. NUT SETTER | 5 | \$8.70 |
| NS-085-16 | 1/4" | X | 6" | MAG. NUT SETTER | 5 | \$11.83 |
| NS-042-20 | 5/16" | X | 1-3/4" | MAG. NUT SETTER | 10 | \$2.55 |
| NS-053-20 | 5/16" | X | 2-1/8" | MAG. NUT SETTER | 10 | \$3.05 |
| NS-065-20 | 5/16" | X | 2-9/16" | MAG. NUT SETTER | 10 | \$3.25 |
| NS-075-20 | 5/16" | X | 4" | MAG. NUT SETTER | 5 | \$10.44 |
| NS-085-20 | 5/16" | X | 6" | MAG. NUT SETTER | 5 | \$15.79 |
| NS-042-24 | 3/8" | X | 1-3/4" | MAG. NUT SETTER | 10 | \$3.25 |
| NS-053-24 | 3/8" | X | 2-1/8" | MAG. NUT SETTER | 10 | \$4.25 |
| NS-065-24 | 3/8" | X | 2-9/16" | MAG. NUT SETTER | 10 | \$4.65 |
| NS-075-24 | 3/8" | X | 4" | MAG. NUT SETTER | 5 | \$11.97 |
| NS-085-24 | 3/8" | X | 6" | MAG. NUT SETTER | 5 | \$19.98 |
| NS-042-28 | 7/16" | X | 1-3/4" | MAG. NUT SETTER | 5 | \$6.75 |
| NS-053-28 | 7/16" | X | 2-1/8" | MAG. NUT SETTER | 5 | \$7.56 |
| NS-065-28 | 7/16" | X | 2-9/16" | MAG. NUT SETTER | 5 | \$7.99 |
| NS-042-32 | 1/2" | X | 1-3/4" | MAG. NUT SETTER | 5 | \$7.45 |
| NS-065-32 | 1/2" | X | 2-9/16" | MAG. NUT SETTER | 5 | \$8.65 |



- ◆ Made for Powerful Impact Drivers / Wrenches
- ◆ 1pc Construction
- ◆ Industrial Grade Magnet
- ◆ 1/4" Hex Power Shank



IMPACT
1/4" HEX IMPACT SHANK



MAGNETIC



1-3/4" Long



2-9/16" Long



4" Long



- ◆ 1pc Construction
- ◆ Industrial Grade Magnet
- ◆ 1/4" Hex Power Shank



1-3/4" Long



2-1/8" Long



2-9/16" Long



4" Long

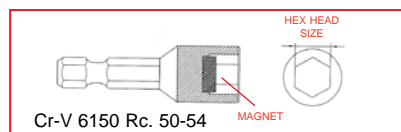

Cr-V 6150 Rc. 50-54

MAGNET

COMES WITH CASE AND HANDLE!



30 Pc. Screwdriver Insert Set - STANDARD

| Part # | Description | List |
|-----------|--|---------|
| ST-100-30 | <ul style="list-style-type: none"> ⊕ Phillips: #1, #2, #3 ⊖ Slotted: 3-4, 4-5, 6-8, 8-10 ⊕ Posidriv: #1, #2, #3 ⊖ Square: #0, #1, #2, #3 ⊖ Hex: 5/64", 3/32", 7/64", 1/8", 9/64" ⊖ Star: T10, T15, T20, T25, T27, T30, T40 ● 1" Long Socket Adaptor ● 3" Long Bit Holder | \$41.64 |

COMES WITH CASE AND HANDLE!



30 Pc. Screwdriver Insert Set - TAMPER PROOF

| Part # | Description | List |
|-----------|--|---------|
| TR-100-30 | <ul style="list-style-type: none"> ⊖ Spanner: #6, #8, #10 ⊕ Posidriv: #1, #2, #3 ⊖ Tri-Wing: #1, #2, #3 ⊖ Hex Tamper: 3/32", 1/8", 9/64", 5/32", 3/16", 7/32", 1/4", 5/16" ⊖ Star Tamper: T8, T9, T10, T15, T20, T25, T27, T30, T40 ● 1" Long Socket Adaptor ● 3" Long Bit Holder | \$52.25 |



32 Pc. Screwdriver Insert Set - STANDARD

| Part # | Description | List |
|---------|---|---------|
| TECH-32 | <ul style="list-style-type: none"> ⊕ Phillips: #0, #1, #2 (2), #3, #2DW (2) ⊖ Slotted: 6-8, 8-10, 10-12 ⊖ Square: #0, #1, #2 (3), #3 ⊖ Hex: 5/64", 3/32", 7/64", 1/8", 5/32", 3/16" ⊖ Star: T8, T10, T15, T20, T25, T27, T30, T40 ● 1/4" Impact Driver Adaptor ● 1/4" Auto Locking Magnetic Bit Holder | \$40.79 |



← Belt Clip



32 Pc. Screwdriver Insert Set - TAMPER PROOF

| Part # | Description | List |
|-----------|---|---------|
| TECH-32TR | <ul style="list-style-type: none"> ⊖ Spanner: #6, #8, #10, #12, #14 ⊖ Star Tamper: T8, T9, T10, T15, T20, T25, T27, T30, T40 ⊖ Hex Tamper: 3/32", 1/8", 9/64", 5/32", 3/16", 7/32", 1/4", 5/16" ⊖ Tri-Wing: #1, #2, #3 ⊖ Square: #1, #2, #3 ⊕ Phillips: #2, #3 ● 1/4" Impact Driver Adaptor ● 1/4" Auto Locking Magnetic Bit Holder | \$48.12 |

US PATENT 5265504

Made In

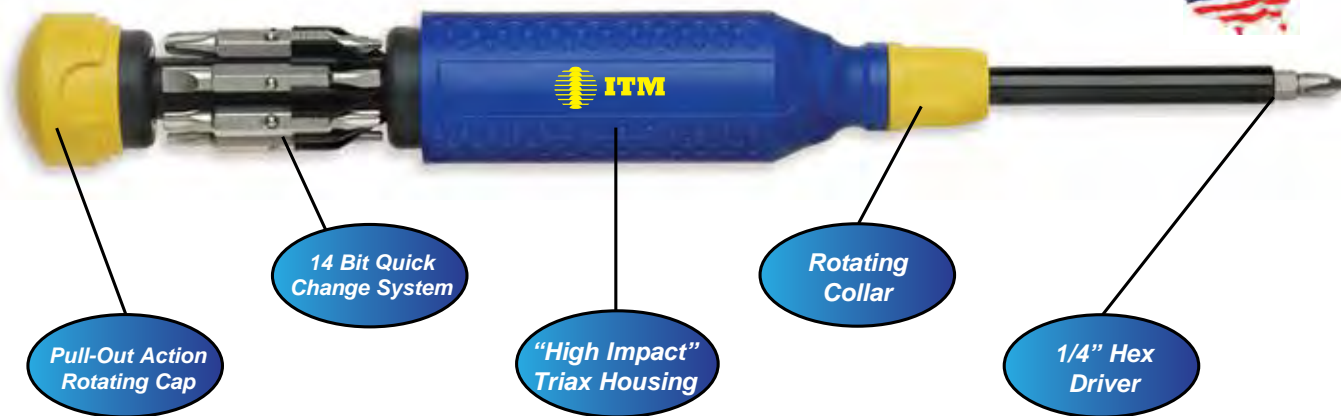

| Part # | Description | List |
|------------|---|---------|
| MEGAPRO151 | 15-IN-1 MEGAPRO SCREWDRIVER | \$41.19 |
| | #0 - #3 PHILLIPS #10 - #15 STAR #1 - #2 PHILLIPS #20 - #25 STAR #0 - #3 SQUARE #4 - #6 SLOTTED #1 - #2 SQUARE | |



MEGAPRO

| Part # | Description | List |
|------------|---|---------|
| MEGATAM151 | 15-IN-1 TAMPERPROOF SCREWDRIVER | \$52.47 |
| | #6 - #8 SPANNER #10 - #15 STAR PIN #10 - #12 SPANNER #20 - #25 STAR PIN 1/8" - 9/64" HEX PIN #27 - #30 STAR PIN 5/32" - 3/16" HEX PIN | |



Tamper Proof Tamper Proof Driver sold Individually Tubed.

| Part # | Description | List |
|--------|-------------------------------|--------|
| 470001 | #0 - #3 PHILLIPS® | \$2.50 |
| 470002 | #1 - #2 PHILLIPS® | \$2.50 |
| 470003 | #0 - #3 SQUARE | \$2.50 |
| 470004 | #1 - #2 SQUARE | \$2.50 |
| 470005 | #10 - #15 STAR | \$2.50 |
| 470006 | #20 - #25 STAR | \$2.50 |
| 470009 | #27 - #30 STAR (SPECIAL SIZE) | \$2.50 |
| 470007 | #4 - #6 SLOTTED | \$2.50 |
| 690001 | #6 - #8 SPANNER | \$2.75 |
| 690002 | #10 - #12 SPANNER | \$2.75 |
| 690003 | 1/8" - 9/64" HEX PIN | \$2.75 |
| 690004 | 5/32" - 3/16" HEX PIN | \$2.75 |
| 690005 | #10 - #15 STAR PIN | \$2.75 |
| 690006 | #20 - #25 STAR PIN | \$2.75 |
| 690007 | #27 - #30 STAR PIN | \$2.75 |

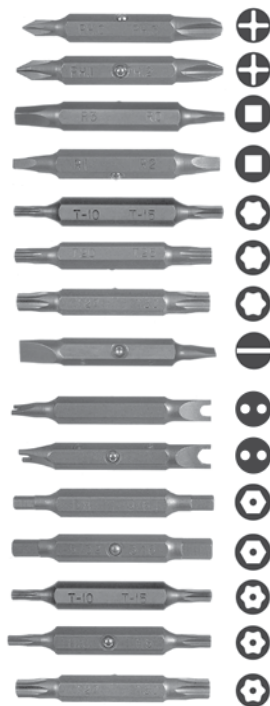

Replacement bits for the Megapro & Megapro Tamper Proof are sold individually.

PHILLIPS® IS A REGISTERED TRADEMARK OF PHILLIPS SCREW CO.



- ◆ Manufactured of 100% Nylon
- ◆ Non-Corrosive
- ◆ Specification: Type 6.6 Nylon
- ◆ Self-Extinguishing
- ◆ Natural & Weather Resistant Black Operating Temperatures From 40° F (-40° C) to 185° F (85° C).
- ◆ Recognized Under the Components Program of Underwriter Laboratories, Inc.

File # E 57800.

NATURAL NYLON 6.6 CABLE TIES

| Part # | Length | Tensile Strength | Width | Bundle Diameter | Military Specification | Pack Qty. | List / 100 |
|----------|--------|------------------|-------|-----------------|------------------------|-----------|------------|
| MS0016-C | 4" | 18 lbs. | 3/32" | 1/16" → 5/8" | MS-3367-4-9 | 100 | \$4.18 |
| MS0032-C | 5.5" | 40 lbs. | 1/8" | 1/16" → 1-1/4" | MS-3367-5-9 | 100 | \$5.22 |
| MS0050-C | 8" | 50 lbs. | 1/8" | 1/16" → 2-1/8" | MS-3367-1-9 | 100 | \$6.32 |
| MS0070-C | 11" | 50 lbs. | 3/16" | 1/16" → 3" | MS-3367-7-9 | 100 | \$13.92 |
| MS0108-C | 15" | 50 lbs. | 3/16" | 1/16" → 4" | MS-3367-2-9 | 100 | \$19.14 |

NATURAL NYLON 6.6 CABLE TIES - EXTRA HEAVY DUTY

| Part # | Length | Tensile Strength | Width | Bundle Diameter | Military Specification | Pack Qty. | List / 100 |
|---------|--------|------------------|-------|-----------------|------------------------|-----------|------------|
| XMS0050 | 8" | 120 lbs. | 5/16" | 3/16" → 2" | - | 100 | \$17.69 |
| XMS0070 | 11" | 120 lbs. | 5/16" | 3/16" → 3" | - | 100 | \$19.67 |
| XMS0108 | 15" | 120 lbs. | 5/16" | 3/16" → 4" | - | 100 | \$22.74 |
| XMS0152 | 24" | 175 lbs. | 3/8" | 3/16" → 7" | - | 100 | \$41.45 |
| XMS0225 | 36" | 175 lbs. | 3/8" | 3/16" → 10" | - | 100 | \$48.02 |
| XMS0300 | 48" | 175 lbs. | 3/8" | 3/16" → 12" | - | 100 | \$71.94 |

BLACK WEATHER RESISTANT NYLON CABLE TIES

| Part # | Length | Tensile Strength | Width | Bundle Diameter | Military Specification | Pack Qty. | List / 100 |
|-----------|--------|------------------|-------|-----------------|------------------------|-----------|------------|
| BWR0016-C | 4" | 18 lbs. | 3/32" | 1/16" → 5/8" | MS-3367-4-0 | 100 | \$5.02 |
| BWR0032-C | 5.5" | 40 lbs. | 1/8" | 1/16" → 1-1/4" | MS-3367-5-0 | 100 | \$6.26 |
| BWR0050-C | 8" | 50 lbs. | 1/8" | 1/16" → 2-1/8" | MS-3367-1-0 | 100 | \$7.58 |
| BWR0070-C | 11" | 50 lbs. | 3/16" | 1/16" → 3" | MS-3367-7-0 | 100 | \$14.99 |
| BWR0108-C | 15" | 50 lbs. | 3/16" | 1/16" → 4" | MS-3367-2-0 | 100 | \$20.69 |

BLACK WEATHER RESISTANT NYLON CABLE TIES - EXTRA H.D.

| Part # | Length | Tensile Strength | Width | Bundle Diameter | Military Specification | Pack Qty. | List / 100 |
|---------|--------|------------------|-------|-----------------|------------------------|-----------|------------|
| XBWR050 | 8" | 120 lbs. | 5/16" | 3/16" → 2" | - | 100 | \$17.99 |
| XBWR070 | 11" | 120 lbs. | 5/16" | 3/16" → 3" | - | 100 | \$20.27 |
| XBWR108 | 15" | 120 lbs. | 5/16" | 3/16" → 4" | - | 100 | \$25.72 |
| XBWR152 | 24" | 175 lbs. | 3/8" | 3/16" → 7" | - | 100 | \$45.15 |
| XBWR225 | 36" | 175 lbs. | 3/8" | 3/16" → 10" | - | 100 | \$56.60 |
| XBWR300 | 48" | 175 lbs. | 3/8" | 3/16" → 12" | - | 100 | \$85.19 |

**CABLE TIE WITH SCREW MOUNT HOLE**

| Part # | Length | Tensile Strength | Width | Bundle Diameter | Military Specification | Pack Qty. | List / 100 |
|----------------|--------|------------------|-------|-----------------|------------------------|-----------|------------|
| NATURAL | | | | | | | |
| WCM0050 | 8" | 50 lbs. | 1/8" | 1/16" → 2-1/8" | - | 100 | \$8.89 |
| WCM0070 | 11" | 50 lbs. | 3/16" | 1/16" → 3" | - | 100 | \$16.90 |
| WCM0108 | 14" | 50 lbs. | 3/16" | 1/16" → 4" | - | 100 | \$17.80 |
| BLACK | | | | | | | |
| BCM0050 | 8" | 50 lbs. | 1/8" | 1/16" → 2-1/8" | - | 100 | \$8.89 |
| BCM0070 | 11" | 50 lbs. | 3/16" | 1/16" → 3" | - | 100 | \$16.90 |
| BCM0108 | 14" | 50 lbs. | 3/16" | 1/16" → 4" | - | 100 | \$17.80 |



CONICAL ANCHOR - BLUE

| | |
|------------------------|-----------------------------|
| PART# 807AK0010 | |
| 100 pcs. | - 3/16" Conical Anchors |
| 100 pcs. | - #8 Combo Screws |
| 1 pc. | - 3/16" Slow Spiral Masonry |
| List | \$7.65 |



RIBBED ANCHOR - GREY

| | |
|------------------------|-----------------------------|
| PART# 807AK0006 | |
| 100 pcs. | - 3/16" Ribbed Anchors |
| 100 pcs. | - #8 Combo Screws |
| 1 pc. | - 3/16" Slow Spiral Masonry |
| List | \$8.57 |



SUPER ANCHOR - YELLOW

| | |
|------------------------|-----------------------------|
| PART# SUPRAK006 | |
| 100 pcs. | - 3/16" SUPER Anchors |
| 100 pcs. | - #8 Combo Screws |
| 1 pc. | - 3/16" Slow Spiral Masonry |
| List | \$8.52 |



ZAP-IN ANCHOR

| | |
|-----------------------|------------------------|
| PART# EZZ-PACK | |
| 50 pcs. | - Zinc Zap-In |
| 50 pcs. | - #8 x 1" Combo Screws |
| 1 pc. | - #2 X 2" Phillips Bit |
| List | \$25.46 |

| | |
|------------------------|----------------------------|
| PART# 807AK0011 | |
| 100 pcs. | - 1/4" Conical Anchors |
| 100 pcs. | - #10 Combo Screws |
| 1 pc. | - 1/4" Slow Spiral Masonry |
| List | \$9.58 |

| | |
|------------------------|----------------------------|
| PART# 807AK0016 | |
| 100 pcs. | - 1/4" Ribbed Anchors |
| 100 pcs. | - #10 Combo Screws |
| 1 pc. | - 1/4" Slow Spiral Masonry |
| List | \$9.58 |

| | |
|------------------------|-----------------------------|
| PART# SUPRAK008 | |
| 100 pcs. | - 1/4" SUPER Anchors |
| 100 pcs. | - #10 x 1 1/4" Combo Screws |
| 1 pc. | - 1/4" Slow Spiral Masonry |
| List | \$11.20 |

| | |
|------------------------|-----------------------------|
| PART# 807AK0013 | |
| 50 pcs. | - 5/16" Conical Anchors |
| 50 pcs. | - #12 Combo Screws |
| 1 pc. | - 5/16" Slow Spiral Masonry |
| List | \$11.56 |

| | |
|------------------------|-----------------------------|
| PART# 807AK0009 | |
| 50 pcs. | - 5/16" Ribbed Anchors |
| 50 pcs. | - #12 Combo Screws |
| 1 pc. | - 5/16" Slow Spiral Masonry |
| List | \$11.56 |

| | |
|------------------------|-----------------------------|
| PART# SUPRAK009 | |
| 50 pcs. | - 5/16" SUPER Anchors |
| 50 pcs. | - #12 x 1 1/2" Combo Screws |
| 1 pc. | - 5/16" Slow Spiral Masonry |
| List | \$11.57 |



COMBO SCREW

Anchor Kits



ZAP-IN Anchors - Zamac Alloy

| Part # | OAL | Description | Box Qty. | Packaged | List / C |
|----------|---------|--------------------|----------|----------|----------|
| EZZ1212 | 1-5/16" | ZAP IN ZAMAC ALLOY | 100 | BOX | \$42.19 |
| EZZ1212B | 1-5/16" | ZAP IN ZAMAC ALLOY | 2,000 | BULK | \$36.36 |

- ◆ Industrial Quality
- ◆ Ideal for Fastening to Drywall and Other Low Density Substrates
- ◆ Easily Removable by Simply Backing Out Screw



Hammer Drive Nail-In Anchors - Zamac

| Part # | Size | Description | Drill | Box Qty. | List / C |
|---------|---------------|-------------|-------|----------|----------|
| HD14340 | 1/4" X 3/4" | MUSHROOM | 1/4" | 100 | \$23.67 |
| HD14010 | 1/4" X 1" | MUSHROOM | 1/4" | 100 | \$26.17 |
| HD14114 | 1/4" X 1-1/4" | MUSHROOM | 1/4" | 100 | \$30.00 |
| HD14112 | 1/4" X 1-1/2" | MUSHROOM | 1/4" | 100 | \$33.33 |
| HD14200 | 1/4" X 2" | MUSHROOM | 1/4" | 100 | \$38.33 |

Meets or exceeds GSA Specification FF-S-325, Group V, Type 2, Class 3.

EASY TO INSTALL

No screws necessary. Just drill 1/4" hole and hammer in the anchor.

- Hollow Wall
- Solid Wall
- Concrete
- Stone
- Brick
- Plaster
- Sheet Metal



Split Drive Anchors - Zinc Plated

| Part # | Size | Minimum Embedment | Drill | Box Qty. | List / C |
|----------|---------------|-------------------|-------|----------|----------|
| FDA14150 | 1/4" X 1-1/2" | 1-1/8" | 1/4" | 100 | \$18.89 |
| FDA14200 | 1/4" X 2" | 1-1/8" | 1/4" | 100 | \$26.04 |
| FDA14250 | 1/4" X 2-1/2" | 1-1/8" | 1/4" | 100 | \$26.39 |
| FDA14300 | 1/4" X 3" | 1-1/8" | 1/4" | 100 | \$34.17 |
| FDA14350 | 1/4" X 3-1/2" | 1-1/8" | 1/4" | 100 | \$41.67 |
| FDA14400 | 1/4" X 4" | 1-1/8" | 1/4" | 100 | \$47.15 |

Meets or exceeds GSA Specification FF-S-325, Group IV.

EASY TO INSTALL

No screws necessary. Just drill 1/4" hole and hammer in the anchor.

- ◆ Carbon Steel Construction
- ◆ Flat Head
- Concrete
- Stone
- Solid Brick



- ◆ Retractable 3 Blade Positions
- ◆ Extra Blade Inside Compartment
- ◆ Carded and Sold Individually



Carded Utility Knife - 1 Pack

| Part # | Description | List |
|---------|---------------|--------|
| UTK0001 | UTILITY KNIFE | \$6.95 |

- ◆ Retractable 3 Blade Positions
- ◆ 3 Blades In Each Knife
- ◆ Heavy Duty Die Cast Aluminum
- ◆ Pull Out Mechanism For Quick Blade Change

FREE COUNTER DISPLAY WITH EVERY ORDER.



Quick Release Utility Knife - 12 Pack

| Part # | Description | List |
|---------|-----------------------|------------|
| UTK0002 | UTILITY KNIFE (12 PK) | \$12.50/ea |

- ◆ Double Sided Tooth Geometry
- ◆ Narrow Blade Ideal For Awkward Cuts
- ◆ Carded And Sold Individually



6" Wallboard Saw - 1 Pack

| Part # | Description | List |
|--------|------------------|--------|
| WS-6 | 6" WALLBOARD SAW | \$6.40 |

- ◆ 6 in 1 Quick Change
- ◆ Industrial Quality

SOLD IN 12 PIECE DISPLAY BOX ONLY.



6-IN-1 Combination Screwdriver

| Part # | Description | List |
|-----------|---|-----------|
| ST-100-20 | 6-IN-1 SCREWDRIVER #1, #2, PHILLIPS 1/4" NUT SETTER #5, #8-10, SLOTTED 5/16" NUT SETTER | \$7.25/ea |

- ◆ Heavy Duty
- ◆ Fits All Standard Knives
- ◆ Made in Taiwan



Heavy Duty Utility Blades

| Part # | Description | Qty. | List |
|---------|-------------------------|------|---------|
| HDB9005 | INDIVIDUAL PACK | 5 | \$1.95 |
| HDB9100 | 100 PACK (20 X 5 PACKS) | 100 | \$25.24 |

Dust Masks / Safety Goggles

| Part # | Description | Qty. | List |
|---------|----------------|------|--------|
| MSK55 | SINGLE STRAP | 5 | \$2.80 |
| GOG0001 | SAFETY GOGGLES | 1 | \$4.15 |